

MS2N Synchronous Servomotors

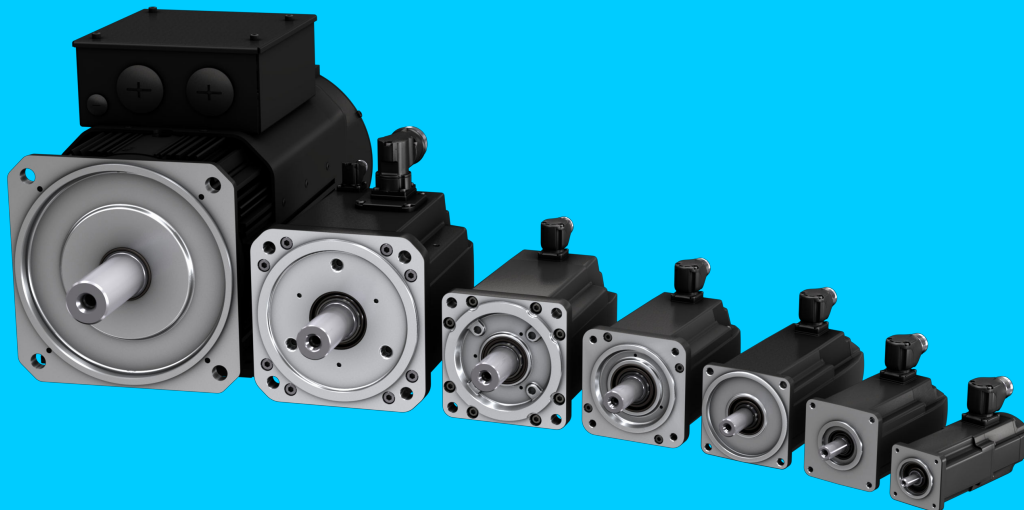

Copyright

© Bosch Rexroth AG 2022

All rights reserved, also regarding any disposal, exploitation, reproduction, editing, distribution, as well as in the event of applications for industrial property rights.

Liability

The specified data is intended for product description purposes only and shall not be deemed to be a guaranteed characteristic unless expressly stipulated in the contract. All rights are reserved with respect to the content of this documentation and the availability of the product.

DOK-MOTOR*-MS2N*****-PR08-EN-P

DC-AE/EPI5 (jw, mb)

Table of contents

1	About this documentation	7
1.1	Purpose and editions of this documentation.	7
1.2	Presentation of information.	7
2	Safety instructions	11
2.1	Important directions on use.	11
2.1.1	Intended use	11
2.1.2	Unintended use	11
2.2	Qualification of personnel.	12
2.3	General safety instructions.	12
2.4	Product- and technology-dependent safety instructions	12
2.4.1	Protection from electric voltage.	12
2.4.2	Protection from mechanical danger.	13
2.4.3	Protection against magnetic and electromagnetic fields.	13
2.4.4	Protection against burns.	14
2.4.5	Electrostatic sensitive devices (ESD).	14
3	Identification	15
3.1	Type plate	15
3.2	Safety instructions on the product.	15
4	Features and functions	17
4.1	Basic data.	17
4.2	Mechanical interfaces.	18
4.3	Rotor inertia.	19
4.4	Winding code.	19
4.5	Thermal motor protection	20
4.6	Cooling mode.	21
4.6.1	Overview of cooling types.	21
4.6.2	Self-cooling (IC410)	21
4.6.3	Forced ventilation (IC416)	21
4.6.4	Water cooling (IC3W7)	22
4.7	Motor encoder	26
4.8	Degree of protection	27
4.9	Output shaft, balancing and extension elements	28
4.9.1	Shaft end.	28
4.9.2	Balancing	29
4.9.3	Attachment of drive elements	29
4.10	Direction of rotation.	30
4.11	Holding brake.	30
4.11.1	Technical data holding brakes.	31
4.11.2	Sizing holding brakes.	33
4.11.3	Energy saving function for holding brakes.	34
4.11.4	Holding brakes safety instructions.	34
4.11.5	Holding brake - commissioning and maintenance instructions	35
4.12	Flange exactness	35
4.12.1	Concentricity tolerance of the shaft end	35
4.12.2	Concentricity and alignment	36

4.13	Vibration behavior	36
4.14	Bearing	37
4.14.1	Bearing service life	37
4.14.2	Explanation of radial and axial force	38
4.15	Frame size, installation type	38
4.16	Coating	39
4.17	Air-pressure connection.	39
4.18	Additional ground connection	40
4.19	Noise emission.	40
5	Type codes	41
5.1	MS2N03 Type code	41
5.2	MS2N04 Type code	42
5.3	MS2N05 Type code	43
5.4	MS2N06 Type code	44
5.5	MS2N07 Type code	45
5.6	MS2N10 Type code	47
5.7	MS2N13 Type code	49
6	Operating areas and characteristic curves	51
6.1	Operating area	51
6.1.1	Continuous operation S1	52
6.1.2	Periodic intermitted operation S3	52
6.1.3	Operation in field weakening	52
6.1.4	Motor torque during operation at standstill.	53
6.2	Characteristic curves for DC bus voltage	54
6.3	Rated data	55
6.4	Tolerances.	55
6.5	Temperature influence and tolerance	56
6.6	Characteristic curve in gearbox mounting	57
6.7	IndraSize	58
7	Technical data	59
7.1	MS2N03 Technical data.	59
7.1.1	Self-cooling.	59
7.1.2	Specification MS2N03 Self-cooling with M17 double plug / M23 single cable connector	66
7.1.3	Specification MS2N03 Self-cooling with M17 single cable connector	67
7.1.4	MS2N03 Axial force.	68
7.1.5	MS2N03 Radial force.	68
7.2	MS2N04 Technical data.	71
7.2.1	Self-cooling.	71
7.2.2	MS2N04 Self-cooling specification.	84
7.2.3	MS2N04 Axial force.	86
7.2.4	MS2N04 Radial force.	86
7.3	MS2N05 Technical data.	89
7.3.1	Self-cooling.	89
7.3.2	MS2N05 Self-cooling specification.	102
7.3.3	MS2N05 Axial force.	104
7.3.4	MS2N05 Radial force.	104

7.4	MS2N06	Technical data.	107
7.4.1		Self-cooling.	107
7.4.2		MS2N06 Self-cooling specification.	124
7.4.3		MS2N06 Axial force.	125
7.4.4		MS2N06 Radial force.	125
7.5	MS2N07	Technical data.	129
7.5.1		Self-cooling.	129
7.5.2		Forced ventilation.	169
7.5.3		Water cooling.	207
7.5.4		Self-cooling specification	230
7.5.5		Forced ventilation specification	231
7.5.6		Water cooling specification	232
7.5.7		MS2N07 Axial force.	233
7.5.8		MS2N07 Radial force.	233
7.6	MS2N10	Technical data.	237
7.6.1		Self-cooling.	237
7.6.2		Forced ventilation.	275
7.6.3		Water cooling.	311
7.6.4		Self-cooling specification with connector	340
7.6.5		Forced ventilation specification with terminal boxes	342
7.6.6		Specification forced ventilation with connector	343
7.6.7		Water cooling with terminal boxes "C" specification.	344
7.6.8		Water cooling with connectors "A, B" or terminal box "T" specification.	345
7.6.9		MS2N10 Axial force.	346
7.6.10		MS2N10 Radial force.	346
7.7	MS2N13	Technical data.	351
7.7.1		Self-cooling.	351
7.7.2		Forced ventilation.	369
7.7.3		Water cooling.	387
7.7.4		Specification self-cooling	404
7.7.5		Forced ventilation specification	405
7.7.6		Water cooling specification	406
7.7.7		MS2N13 Axial force.	407
7.7.8		MS2N13 Radial force.	407
8	Electrical connection		411
8.1		Overview of connection variants.	411
8.2		Circuit diagram.	412
8.2.1		Single cable connection for MS2N with encoder (digital C, D, H) and optional brake	412
8.2.2		Single cable connection for MS2N with encoder (digital C, D, H) and optional brake	412
8.2.3		Double cable connection for MS2N with encoder (analog A, B) and optional brake	413
8.2.4		Double cable connection terminal box for MS2N with encoder (digital C, D, H) and optional brake.	413
8.2.5		Double cable connection terminal box for MS2N with encoder (analog A, B) and optional brake.	414

8.2.6	Double cable connection terminal box for MS2N with encoder (digital C, D, H) and optional brake.	414
8.2.7	Fan 1-phase 115 V.	415
8.2.8	Fan 1-phase 230 V.	415
8.2.9	Fan 3-phase 400 / 480 V.	415
8.3	M17 Encoder connector	416
8.4	M17 Double plug	418
8.5	M17 single cable connector, rotatable (SpeedTec).	420
8.6	M23 single cable connector, rotatable (SpeedCon).	421
8.7	M23 cable connector, rotatable (SpeedCon).	422
8.8	M40 cable connector, rotatable (SpeedCon).	423
8.9	M58 cable connector, fixed (thread).	424
8.10	Terminal box size "T"	425
8.11	Terminal boxes size "C" (MS2N10)	427
8.12	Terminal boxes size "C" (MS2N13)	429
8.13	Terminal box size "E"	431
8.14	Fan 1-phase 115 / 230 V.	433
8.15	Fan 3-phase 400 / 480 V.	434
8.16	Ground connection	434
8.17	Shielding concept	435
8.18	Ready-made connecting cable.	435
9	Connection water cooling	437
10	Sealing air connection	441
11	Ambient conditions	443
11.1	Ambient conditions during operation	443
11.1.1	Vibration load during operation	443
11.2	Derating in case of deviating ambient conditions.	444
11.3	Operation on foreign converters	446
11.4	Transport.	447
11.4.1	Instructions on machine transport.	447
11.5	Storage.	448
11.6	Shock load during transport und storage	449
12	Service repair, maintenance and spare parts	451
13	Environmental protection and disposal	453
14	Appendix	455
14.1	CE conformity.	455
14.2	UL / CSA	455
14.3	China RoHS 2	455
14.4	China Energy Label (CEL).	455
15	Index	457

1 About this documentation

1.1 Purpose and editions of this documentation

This documentation explains the product characteristics, application possibilities, operating conditions and the operational limits of the motors, contains the technical data of the available motors and provides information on product selection, handling and operation.

Table 1: Record of revisions



Edition	Release date	Notes
01	2016-06	First edition
02	2017-03	Water cooling, further motor types
03	2017-11	Extending product range
04	2019-05	Extending product range: Terminal boxes size "C", motor encoder Hx Radial force: Details about motor frame sizes and lengths Replaced holding brake size 1 for frame size -05, -06 Editorial revision
05	2020-12	Extending product range: Frame size 13 Editorial revision
06	2021-05	Extending product range: Frame size 03A Extending product range: Frame size 13 Second PT1000 in MS2N13 terminal boxes Information China Energie Level Editorial revision
07	2021-06	Chapter motor encoders, corrections
08	2022-05	Extending product range: Frame size 13

1.2 Presentation of information

Safety instructions

The safety instructions in this documentation include signal words (danger, warning, caution, note) and a signal symbol (acc. to ANSI Z535.6-2006).









The signal word is intended to draw your attention to the safety instructions and describes the seriousness of the danger. The warning triangle with exclamation mark indicates the danger for persons.

 DANGER	Non-compliance with this safety instructions will result in death or severe personal injury.
 WARNING	Non-compliance with this safety instructions can result in death or severe personal injury.
 CAUTION	Non-compliance with this safety instructions can result in moderate or minor personal injury.
NOTICE	Non-compliance with this safety instructions can result in material damage.

Safety symbols





In the documentation, the following internationally standardized safety signs and graphic symbols are used. The meaning of the symbols is described in the table.

Table 2: Meaning of safety signs

Safety symbols	Meaning
	Warning against dangerous electric voltage
	Warning against hot surfaces
	Warning against rotating machine parts
	Warning against overhead load
	Electrostatic sensitive devices
	Prohibited for persons with active implantable medical devices (AIMD) or passive metallic implants (body aids) as well as for pregnant women
	Do not carry along metal parts or clocks.
	Hammer scales are forbidden

Meaning of symbols

Table 3: Meaning of symbols

Symbol	Meaning
	Reference to supplementary documentation
	The UL Recognized Component Mark identifies recognized component parts which are components of a bigger product or system.
	The letters “C” and “E” stand for “Conformité Européenne”. The CE-marking expresses the conformity of a product with relevant EC-regulations.
	Components for the use in systems for “integrated safety technique” prepared.
	The symbol indicating "separate collection" for all batteries and accumulators is the crossed-out wheeled bin.

Markup

The following markups are used for a user-friendly text information representation:



Remark

This note gives important information, which must be observed.



- Listings on the first level contain a bullet point
 - Listings on the second level contain a dash

Instruction

→ Instruction

➔ Result of one instruction

Instruction multilevel

1.  Action step one
2.  Action step two
 - ➔ Result of an instruction

Please comply with the order of the handling instructions.

Trademark information

HIPERFACE® is a registered trademark of Sick AG 79183 Waldkirch, Germany

EnDat® is a registered trademark of the Dr. Johannes Heidenhain GmbH 83301 Traunreut, Germany

ACURO®link is a registered trademark of Hengstler GmbH 78554 Aldingen, Germany

SPEEDCON® is a registered trademark of PHOENIX CONTACT GmbH & Co. KG 32825 Blomberg, Germany

SpeedTec® is a registered trademark of TE Connectivity Industrial GmbH 94559 Niederwinkling, Germany

2 Safety instructions

2.1 Important directions on use

2.1.1 Intended use

Prerequisites for proper and safe use of the motors are proper transport, appropriate storage, proper assembly and connection, careful maintenance, operation and overhaul.

The motors have been exclusively designed for installation in industrial machinery. The motors have been designed and manufactured in compliance with the directives and harmonized standards specified in the following.

EU Product standard	
EN 60034-1:2010 + Cor.:2010	Rotating electrical machines - Part 1: Rating and performance (IEC 60034-1:2010, modified)

Valid within EU

EU Directives	
2014/35/EU	Low voltage directive

EN Standards	
EN IEC 60034-5:2020	Rotating electrical machines - Part 5: Degrees of protection provided by the integral design of rotating electrical machines (IP code) - Classification (IEC 60034-5:2020)

The machine manufacturer must evaluate the electric and mechanic safety as well as environmental influences in the assembled state of the machine according to the Machine Directive 2006/42/EC and EN 60204-1:2018 Safety of machinery - Electrical equipment of machines -Part 1: General requirements).

The electrical installation must comply with the protection requirements of EMC Directive 2014/30/EU. The plant manufacturer is responsible for appropriate installation (for example: physical separation of signal and power cables, using shielded cables, ...). The EMC instructions of the converter manufacturer must be observed.

The machine may not be commissioned before conformity with these directives has been confirmed.

The observance of and compliance with the specifications of the operating instructions (DOK-MOTOR*-MS2N*****-ITRS-**-P) are part of the intended use.

2.1.2 Unintended use

Any use of MS2N motors outside of the specified fields of application or under operating conditions and technical data other than those specified in this documentation is considered to be unintended use.

Unless explicitly provided for this purpose, the motors may not be used in explosion-hazardous areas.

Direct operation on the three-phase network is forbidden.

2.2 Qualification of personnel

Any work with or on the described product may only be done by qualified or skilled personnel. For the purpose of this manual, qualified personnel means persons who are familiar with transporting, installing, mounting, commissioning and operating the components of the electrical drive and control system and the associated hazards and have an appropriate qualification for their job.

All persons working on, with or in the vicinity of an electrical system must be informed of the relevant safety requirements, safety guidelines and internal instructions EN 50110-1:2013.

2.3 General safety instructions

Important! Please read all instructions before motor installation.

Do not install or operate motors or components of the electric drive and control system before you have not carefully read all delivered documents.

Please observe the particular applicable national, local and system-specific regulations, the safety instructions in the documentation and the warning and informative labels on the motors.

Improper use of the motors and failure to follow the safety instructions in this document may result in material damage, personal injury, electric shock or, in extreme cases, to death!

In the case of damage due to non-observance of the safety notes, Bosch Rexroth assumes no liability.

Applications for functional safety are only allowed if the motors have the SI-sign on the rating plate.

2.4 Product- and technology-dependent safety instructions

2.4.1 Protection from electric voltage

Work required on the electric system may only be carried out by skilled electricians. Tools for electricians (VDE tools) are absolutely necessary.

Before working:

- Enable.
- Secure against reactivation.
- Ensure de-energization.
- Ground and short-circuit.
- Cover or shield any adjacent live parts.

After completing the job, cancel the measures in reverse order.

Dangerous voltage occurs during operation! Danger to life, risk of injury by electric shock!

- Before start-up, connect the protective conductors on all electric components according to the connection plan.
- Operation, even for short measuring purposes is only allowed with fixed connected protective conductor on the specified points of the components.

2.4.2 Protection from mechanical danger

Dangerous movements! Danger to life, risk of injury, heavy injury or material damage.

- Do not stay within the motion zone of the machine. Avoid unauthorized access into the danger zone.
- Additionally secure vertical axes to prevent them from sinking or descending after having shutdown the motor, for instance as follows:
 - Mechanically lock the vertical axis,
 - providing an external braking / catching / clamping device, or
 - ensure sufficient weight compensation of the axes.

Only using the serially delivered **motor holding brake** or an external holding brake activated by the drive controller is **not suitable for personal protection!**

Rotating parts! Danger to life, risk of injury, heavy injury or material damage.

- Secure key and/or transmission elements against ejection.
- Install covers on dangerous rotating machine parts before start-up.

2.4.3 Protection against magnetic and electromagnetic fields

Health hazard for persons with active body aids or passive metallic implants and for pregnant women.

Magnetic and electromagnetic fields are created in the direct environment of live conductors or permanent magnets of electro motors and are a serious danger for persons.

Observe the country-specific regulations. For Germany, please observe the specifications of the occupational insurance association BGV B11 and BGR B11 regarding “electromagnetic fields”.

- For persons with active body aids (like heart pacemakers), passive metallic implants (like hip prosthesis) and pregnant women possible hazards exist due to electro magnetic or magnetic fields in direct environment of electric drive and control components and the corresponding live conductors.

Access into these areas can be dangerous for these persons:

- Areas, in which components of electrical drive and control systems and corresponding live conductors are mounted, activated or operated.
- Areas in which motor parts with permanent magnets are stored, repaired or assembled.
- Above mentioned persons must contact their attending physician before entering these areas.
- Please observe the valid industrial safety regulations for plants which are fitted with components of electrical drive and control systems and corresponding live conductors.

Crushing hazard of fingers and hands due to strong attractive forces of the magnets!

- Handle only with protective gloves.

Risk of destruction of sensitive parts! Data loss!

- Keep watches, credit cards, check cards and identity cards and all ferromagnetic metal parts, such as iron, nickel and cobalt away from permanent magnets.

2.4.4 Protection against burns

Risk of burns due to hot motor surfaces!

- Avoid contact with hot motor surfaces. **Temperatures may rise over 60 °C.**
- Allow the motors to cool down long enough before touching them.
- Temperature-sensitive components may not come into contact with the motor surface. Ensure appropriate mounting distance of connection cables and other components.

2.4.5 Electrostatic sensitive devices (ESD)

The motors contain parts which underlie an electrostatic danger. These components, especially temperature sensors of the motor winding can be destroyed by improper use.

Avoid, e.g. direct contact of open wires or contacts of the connection cable of temperature sensors without being electrostatically discharged or grounded.



Remark

Do suitable ESD protective measures before you handle imperiled components (e.g. ESD protective clothes, wristlets, conductive floor, grounded cabinets and working surfaces).

3 Identification

3.1 Type plate

The type plate contains all relevant product data.

Type plate (example)	
TYPE	Product type code
SN	Serial number
FD	Manufacturing date
P(N)	Rated power - 100K
I(N)	Rated current - 100K
M(0)	Standstill torque - 100K
I(0)	Standstill current - 100K
Brake	Holding brake data (optional)
n(max)	Maximum speed
U(max)	Maximum voltage UL
IP	Degree of protection IPxx
m	Mass
T.CL.	Thermal class
I.SY.	Insulation system identification
SI	Use in systems for "Integrated Safety Technology" prepared.
Fan	Data motor fan (optional)



The following marks of conformity are used:

Certification mark	Meaning
	Conformity with applicable EC Directives For MS2N motors, conformity according to low-voltage directive 2014/35/EU, EN 60034-1:2010 + Cor.:2010, EN IEC 60034-5:2020
	The UL Recognized Component Mark identifies recognized component parts which are components of a bigger product or system.

3.2 Safety instructions on the product

Please note the safety and prohibitive sign on the motor.

Table 4: Safety sign on the product

Safety symbols	Meaning
	<p>Hot surfaces with temperatures over 60 °C may cause burns</p> <p>Let the motors cool down before working on the motors or in close proximity to the motors. The thermal time constant stated in the technical data is a measure for the cooling time. Cooling down can require up to 140 minutes.</p> <ul style="list-style-type: none"> - Wear safety gloves. - Do not work on hot surfaces.
	<p>Warning against dangerous electric voltage</p> <p>Electric connection may only be established by specialized staff. Tools for electricians (VDE tools) are absolutely necessary.</p> <ul style="list-style-type: none"> - The installation has to be switched de-energized before operation and de-energization must be ensured via a suitable measuring device. De-energize the machine and secure the mains switch against unintended or unauthorized re-energization. - Open the terminal boxes only in switched-off voltage.
	<p>Motor damage due to strikes onto the motor shaft</p> <p>Do not strike the shaft end and do not exceed the allowed axial and radial forces of the motor.</p>

4 Features and functions

4.1 Basic data

Product	3~ PM motor
Type	MS2N
Ambient temperature during operation	0 ... 40 °C (with derating up to 60 °C)
Type of protection	IP64 without shaft sealing ring IP65 with shaft sealing ring IP67 with sealing air EN IEC 60034-5:2020
Cooling mode	IC410, Self-cooling IC416, Forced ventilation IC3W7, Water cooling EN 60034-6:1993
Motor design	IM B5 IM B35 (only MS2N13) EN 60034-7:1993 + A1:2001
Coating	Varnish RAL 9005
Flange	similar to DIN 42948:1965-11
Shaft end	Cylindrical (DIN 748-3), centering hole with thread "DS" (DIN 332-2:1983-05), optional with keyway (half key balancing according to ISO 21940-32:2012)
Concentricity, run-out, alignment	Tolerance N (standard) Tolerance R (availability according to type code) DIN 42955:1981-12
Oscillating quantity level	Level A up to rated speed EN IEC 60034-14:2018
Installation altitude	0 ... 1,000 m above sea level (without derating)
Sound pressure level	MS2N03 ... MS2N13: 75 dB(A) +3 dB(A)
Thermal class	155 (F) EN 60034-1:2010 + Cor.:2010
Encoder system	<p>Basic performance HIPERFACE® Capacitive absolute value encoder, sin/cos 1Vss, 16 signal periods as single or multi-turn variant</p> <p>Standard performance HIPERFACE® Optical absolute value encoder, sin/cos 1Vss, 128 bit, digital in single or multiturn variant</p> <p>Advanced Performance ACURO®link Optical absolute value encoder 20 bit, digital in single or multiturn variant</p> <p>High performance ACURO®link Optical absolute value encoder 24 bit, digital in Single- or Multiturn design</p>
Electrical connection	<p>Single cable connection with</p> <ul style="list-style-type: none"> - M17 circular connector, rotatable, quick lock Speedtec® - M23 circular connector, rotatable, quick lock SPEEDCON®

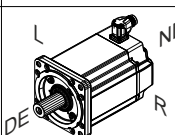
	Double cable connection with Power connectors M17, M23, M40 (rotatable, quick lock SPEEDCON®), M58 or terminal boxes M17 Encoder connector, rotatable, quick lock SPEEDCON®								
Motor holding brake	Optional, electrically released U_N 24V DC ($\pm 10\%$)								
Motor ends	 <table style="display: inline-table; vertical-align: middle;"> <tr> <td>DE</td> <td>Drive End, A-side</td> </tr> <tr> <td>NDE</td> <td>Non Drive End, B-side</td> </tr> <tr> <td>L</td> <td>Left</td> </tr> <tr> <td>R</td> <td>Right</td> </tr> </table>	DE	Drive End, A-side	NDE	Non Drive End, B-side	L	Left	R	Right
DE	Drive End, A-side								
NDE	Non Drive End, B-side								
L	Left								
R	Right								



Remark

In the case of special design, details named in the operating instructions can deviate. In this case, order the supplementary documentation.

4.2 Mechanical interfaces

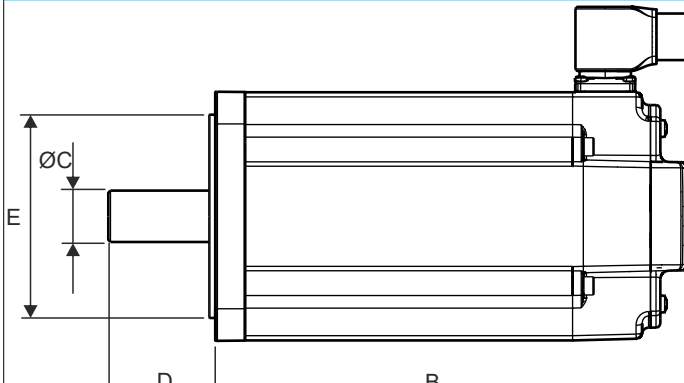
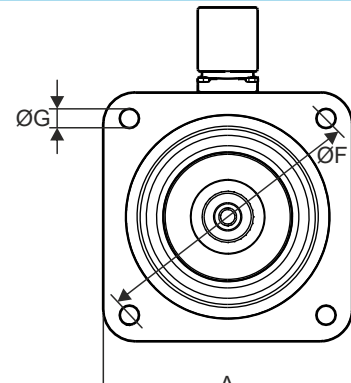
Dimensions (flange)							
							
Type	A □ Flange [mm]	B Length [mm]	C Shaft Ø [mm]	D Shaft length [mm]	E Centering collar [mm]	F Hole circle [mm]	G Mounting holes [mm]
MS2N03-A	58	1)	9	20	40	63	4.5
MS2N03-B	58	1)	9	20	40	63	4.5
MS2N03-D	58	1)	11	23	40	63	4.5
MS2N04	82	1)	14	30	50	95	6.6
MS2N05	98	1)	19	40	95	115	9
MS2N06	116	1)	24	50	95	130	9
MS2N07	140	1)	32	58	130	165	11
MS2N10	196	1)	38	80	180	215	14
MS2N13	260	1)	48	80	255	300	18
1) See specification							

Dimensions (foot)					
Type	A [mm]	L5 Length [mm]	B Bore Ø [mm]	C Distance [mm]	D Distance [mm]
MS2N13-B	89	147	12	68	53
MS2N13-C	89	197	12	68	53
MS2N13-D	89	247	12	68	53
MS2N13-E	89	297	12	68	53

Use the following screws and washers for flange and foot assembly.

Table 5: Mounting screws tightening torque

Screw ¹⁾	M4	M6	M8	M10	M12	M16
Mounting holes Ø [mm]	4.5	6.6	9	11 / 12	14	18
Tightening torque M _A [Nm] bei μ _K = 0.12	3.0	10.1	24.6	48	84	206
Washer	-	-	yes	yes	yes	yes

¹⁾ Screws according to EN ISO 4762:2004 or EN ISO 4014:2011. Fastening class 8.8. The screw lengths depends on material and installation situation. The specified tightening torque must be ensured.

4.3 Rotor inertia

Rotor inertia	Type	MS2N...						
		03	04	05	06	07	10	13
Low inertia	0	●	●	●	●	●	●	-
Mean inertia	1	-	-	-	●	●	●	●

In the “low inertia” design, the motor is optimized for dynamic applications with maximum acceleration capacity.

In the “mean inertia” design, the motor is optimized for applications with increased requirements on controllability and synchronous operation.

4.4 Winding code

The speed to the corresponding winding designations are standard values. The specified rated speed can deviate from the specified in the technical data sheet. The speed is determined to define the winding designation on which the standstill torque - 100 K (M_{S1 100 K}) on the voltage limit characteristic curve U_{ZK 1} is reached (tolerance range ca. ± 250 1/min).

Table 6: Winding code acc. to type code (speed at DC bus voltage U_{ZK 1})

Winding code	Nominal speed [1/min]
BD	1000

Winding code	Nominal speed [1/min]
BF	1,500
BH	2,000
BL	2,500
BN	3,000
BQ	4,000
BR	4500
BT	6,000
BY	9,000

4.5 Thermal motor protection

The motor temperature is monitored by two systems that are operated independently of each other. The mounted **temperature sensor** and the drive-internal **temperature model** ensure the best protection of motors against thermal overload.

The threshold values for motor temperature monitoring are contained in the encoder data memory and are read in and monitored automatically during the operation with Rexroth controllers. Threshold values for MS2N motors:

- Motor-warning temperature (140°C)
- Motor-disconnection temperature (145°C)

Motor	Temperature sensor
MS2N_ - _ - _ - N _ - _	PT1000 (Standard)

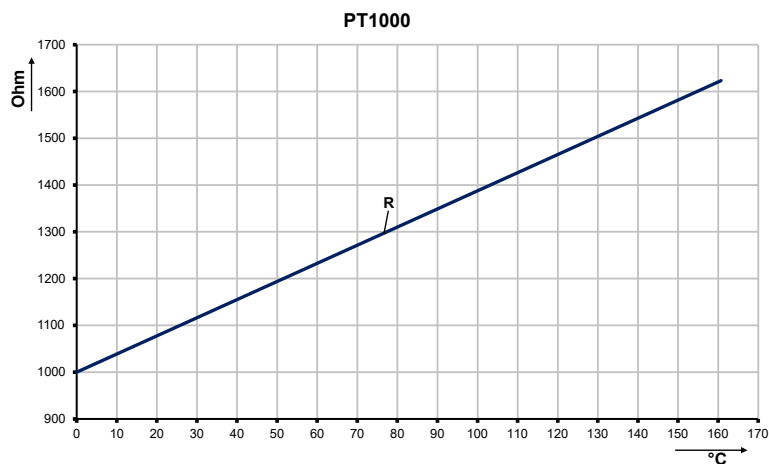

Fig. 1: Characteristic curve PT1000

The output of the motor temperature is dependent from the selected motor encoder variant. In case of motors with an analog encoder (A_, B_), the temperature signal is output via the TP(+) und TP(-) ports in the power connection. In case of motors with digital encoder (C_, D_, H_), the temperature signal is transmitted digitally via the encoder interface (cyclic communication).

The temperature of Rexroth controllers is automatically evaluated via the ACUR-Olink interface of the encoder. You will find information about interface implementation in the manual of the encoder manufacturer, when using other controllers.

Fa. Hengstler:

ACURO Encoder AD37 series – Functional Safety Item number: 2 572 032

4.6 Cooling mode

4.6.1 Overview of cooling types

Motor cooling (EN 60034-6)	Type	MS2N...						
		03	04	05	06	07	10	13
IC410, Self-cooling	N	●	●	●	●	●	●	-
IC416, Forced ventilation 230 V	A	-	-	-	-	●	●	-
IC416, Forced ventilation 115 V	B	-	-	-	-	●	●	-
IC416, Forced ventilation 3 × 400/480 V	C	-	-	-	-	-	-	●
IC3W7, Water cooling	L	-	-	-	-	●	●	●

4.6.2 Self-cooling (IC410)

In case of self-cooling motors, the heat dissipation is realized via natural convection and radiation to the ambient air as well as by heat conduction to the machine construction.

The specified nominal data is reached at ambient temperatures of up to 40 °C. Unhindered vertical convection has to be ensured by a sufficient distance of 100 mm to adjacent components. Any usage at increased ambient temperature (0 ... 60°C) is possible. Please note the details in [Chapter 11.2 Derating in case of deviating ambient conditions on page 444](#).

Pollution of the surface of the motor reduces heat dissipation and can result in thermal overload. The availability of the system can be increased by regular checks and cleaning of the motors. Please ensure access to the motors for maintenance purposes.

4.6.3 Forced ventilation (IC416)

MS2N motors of size **07**, **10** und **13** are available as forced ventilated designs. The designation is done via the feature cooling mode within the type code:

- "A" 230 V (50 / 60 Hz)
- "B" 115 V (60 Hz)
- „C“ 3 × 400 / 480 V (50 / 60 Hz)

In case of force-ventilated motors, the energy dissipation is additionally realized via a fan that is not connected to the motor.

▲ WARNING

Damage to persons and machines due to drawing in of hairs, clothes or loose objects.

Before you get closer to operating fan units, take protective measures. Do not wear jewelry, wear tight-fitting clothes and use personal protective equipment (like a hairnet). Tie your hair back. Otherwise the danger exists that hair will get ripped out.

The specified nominal data is reached at ambient temperatures of up to 40 °C. Unhindered drawing in of cooling air and heat dissipation has to be ensured by minimum distances to the machine environment.

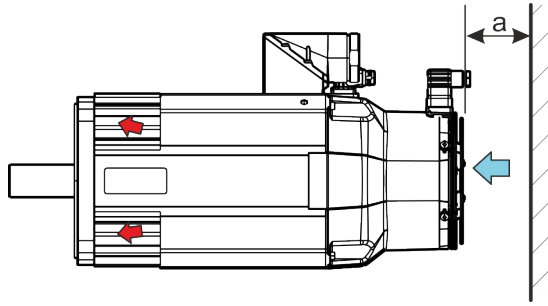

Fig. 2: Minimum distance

a Minimum distance 80 mm

Blowing fans, air flow direction NDE → DE.

Operate fans only in dustfree and dry ambient air. Heated air may not be sucked in again.

Dirt and contaminants can reduce the flow rate of the fans and result in a thermal overload of the motors. The availability of the system can be increased by regular checks and cleaning of the fans and motors. Please ensure access to the motors for maintenance purposes.

Fans are not suited to transfer ambient air,

- containing abrasive particles.
- having a corroding effect (e.g., salt mist).
- containing a high dust concentration (e.g. sawdust).
- with inflammable gas/dust.

4.6.4 Water cooling (IC3W7)

MS2N motors of size **07**, **10** and **13** are available as water-cooled designs. The cooling circuit of the motor is designed with stainless steel. The designation is done via the feature cooling mode „L“ within the motor type code. The nominal data are achieved at ambient temperatures of up to 40 °C.

Cooling system

The motor power loss P_V transformed to heat is dissipated using the coolant. External cooling units are necessary to operate water-cooled motors. Install systems in the cooling circuit for monitoring flow, pressure and temperature.



Remark

Basically, Bosch Rexroth does not claim any warranty for third-party products.

Manufacturers of cooling units

Rittal GmbH & Co. KG	➔ http://www.rittal.com
KKT Kraus Kälte- und Klimatechnik GmbH	➔ http://www.kkt-chillers.com
Glen Dimplex Deutschland GmbH	➔ http://www.riedel-cooling.com
BKW Kälte-Wärme-Versorgungstechnik GmbH	➔ http://www.bkw-kuema.de
Hyfra Industriekühlanlagen GmbH	➔ http://www.hyfra.de

The cooling unit must be able to dissipated heat of the motors at any time. If several motors are operated on one cooling system, this applies to the sum of the individual power losses. The required coolant pressure must also be able to be achieved at maximum volume flow.

The necessary cooling and pump performance is calculated of the sum of connected motors or heat input, the specified minimum flow and pressure loss. The dimensioning of the cooling system is in the responsibility of the machine manufacturer.

Generally, different cooling circuits are used to cool the motors.

- closed cooling circuit (application allowed, no penetration of oxygen possible)
- half-opened cooling circuit (application allowed, penetration of oxygen only possible via surge tank)
- opened cooling circuit (application not allowed, penetration of oxygen unhindered possible)



Remark

Bosch Rexroth recommends to design the cooling circuits as closed system.

The occurring electro-chemical processes within the cooling system must be minimized via selection of the materials. Do not combine different materials, like copper, brass, iron, zinc and halogenated plastics (e.g. tubes and sealing made of PVC).

Fix coolant ducts and check for their tightness in regular intervals.

Potential equalization

Connect all components within the cooling system (e.g. motor, heat exchanger, pipe system, pump, pressure compensation container, etc.) with a potential equalization. Do the potential equalization with a copper bus bar or copper wire with an appropriate conductor cross-section.

Coolant ducts must not contact live parts. Please observe sufficient insulation according to the regulations valid for the place of installation.

Cleaning the coolant circuit

Inspect and clean (purge) the cooling system at regular intervals as specified in the machine and cooling system manufacturer's maintenance schedule. Note that the utilization of unsuitable cleaning agents may cause irreversible damage to the motor cooling system. This type of damage does not lie within the responsibility of Bosch Rexroth.

NOTICE

Damage to the motor cooling system due to unsuitable cleaning agents!

- The only liquids or materials allowed to be used for cleaning and motor cooling are those which do not corrode the motor cooling system or do not react aggressively to the materials used in Bosch Rexroth motors.
- Observe the instructions of the manufacturers of the cleaning agent and the cooling system.

Coolants

The coolant must comply with certain criteria and treated accordingly (see [↔ Coolant characteristics on page 24](#)). To ensure corrosion protection and chemical stabilization admix an additive to the cooling water. The selected coolant additives (**biocides, inhibitors**) must comply with the materials in the cooling system (e.g. copper, brass, stainless steel, etc.) and minimize the micro-biological growth. Pay attention to environmentally friendly materials.

A cooling with floating water from the supply network is not allowed. Floating water can cause sediments (chalk) or corrosion within the cooling system.



Remark

In the case of other used coolants than water (e.g. oil), a performance reduction of the motor can be necessary to dissipate the created power loss. The dimensioning of the cooling system is in the responsibility of the machine manufacturer.

NOTICE	<p>Motor damage due to missing or incompatible coolant water!</p> <ul style="list-style-type: none"> - For this reason, water cooled motors may only be operated as long as coolant supply is ensured. - Do not use any cooling lubricants or cutting materials from machining processes for cooling. - Using aggressive coolant additives or additives can lead to irreparable motor damage.
---------------	---------------------------------------------------------------------------------------------------------------------------------------------------------------------------------------------------------------------------------------------------------------------------------------------------------------------------------------------------------------------------------------------------------------------------------------

Coolant characteristics

Adjust the required coolant, especially the material compatibility must be specified with the manufacturer of the cooling unit and the manufacturer of the coolant additives. The basic minimum requirements for the coolant are displayed in the following.

Cooling water quality for motors with internal cooling circuit made of stainless steel.	
pH value (bei 20 °C)	6 ... 9
Total hardness	1.2 ... 2.5 mmol/l
Chloride concentration	< 150 ppm
Sulfate concentration	< 200 ppm
Nitrate concentration	< 50 ppm
Amount solutes	< 350 ppm
Particle size of dirt	≤ 100 µm
Conductivity	< 2000 µS/cm

Coolant additives

Coolant additives can be purchased from the following manufacturers. Products of other manufacturers can be also be used.

Manufacturer of chemical additives	
Nalco Deutschland GmbH	➔ http://www.nalco.com
FUCHS PETROLUB AG	➔ http://www.fuchs-oil.com
Clariant Produkte (Deutschland) GmbH	➔ http://www.antifrogen.de
hebro chemie GmbH	➔ http://www.hebro-chemie.de
TYFOROP Chemie GmbH	➔ http://www.tyfo.de
Schweizer-Chemie GmbH	➔ http://www.schweitzer-chemie.de

Bosch Rexroth does not make any general statement and does not conduct any surveys regarding the suitability of device-specific cooling media, additives or operating conditions and does not assume any warranty for third-party products.

The performance test for the used cooling media and the design of the liquid cooling system is the responsibility of the machine manufacturer. The selected coolant additives have to comply with the materials within the cooling system.

Comply with the environmental protection and waste disposal instructions at the place of installation when selecting the coolant additives.

The proper chemical treatment of the closed water systems is precondition to prevent corrosion, to maintain thermal transmission, and to minimize the growth of bacteria in all parts of the system.

Coolant additives of NALCO Deutschland GmbH (example):

Coolant water Nalco CCL100 is a ready-to-use, preserved cooling water for use in closed cooling water systems. Nalco CCL100 contains corrosion inhibitor protecting ferrous metal, copper, copper alloys and aluminum. It is free from nitrite and minimizes the micro-biological growth.

Coolant additive NALCO TRAC100 is a liquid corrosion and film inhibitor for the use in closed cooling systems. Nalco TRAC100 is a complete inhibitor protecting ferrous metal, copper alloys and aluminum against corrosion. It is free from nitrite and minimizes the micro-biological growth.

Coolant additive NALCO 7330 is a non-oxidizing broad band biocide and suitable for application in closed cooling circuit systems.

Coolant additive Nalco 73199 is an organic corrosion inhibitor supporting a fast own protection layer and covering protection layer for non-ferrous metals.

Coolant temperature

When setting the coolant inlet temperature within a range of 10 ... 40°C (for derating see → [Chapter 11.2 Derating in case of deviating ambient conditions on page 444](#)) observe the ambient temperature and the existing relative air humidity. To avoid condensation, the coolant inlet temperature must be above the dew point temperature. The following figure shows the dependency of dew point temperature of relative air humidity and air temperature.

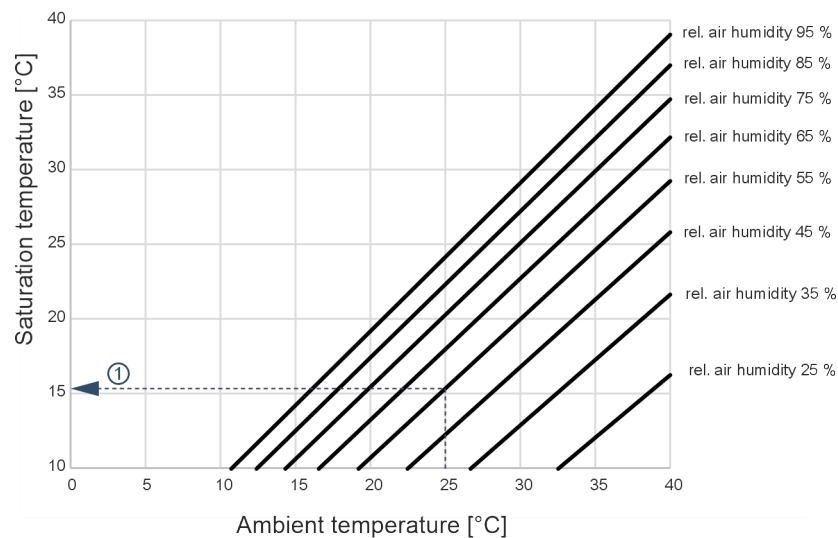

Fig. 3: Dew point temperature depends from ambient temperature and relative air humidity

Example ① Saturation 15.3 °C at ambient temperature of 25°C and relative air humidity of 55%



Remark

To avoid condensation of the motors, the coolant inlet temperature must be above the dew point temperature.

4.7 Motor encoder

BASIC

BASIC encoder "A_" uses a capacitive sampling method. Data output of process data happens analog via SinCos track. Data output of parameter data (electronic type plate) happens digitally via Hiperface®-Protocol. The motor temperature is not transmitted via encoder interface.

STANDARD

STANDARD encoder "B_" uses an optical sampling method. Data output of process data happens analog via SinCos track. Data output of parameter data (electronic type plate) happens digitally via Hiperface®-Protocol. The encoder fulfills the specification for safety technique according to SIL2 and category 3, PL d. The motor temperature is not transmitted via encoder interface.

ADVANCED

ADVANCED encoder "C_"/"H_" uses an optical sampling method. Data output of process and parameter data (electronic type plate) happens digitally via ACURO®link-Protocol. The encoder "C_" fulfills the specification for safety technique according to SIL 2 and category 3, PL d. The encoder "H_" fulfills the specification for safety technique according to SIL 3 and category 3, PL e. The motor temperature is transmitted digitally.

HIGH

HIGH-Geber "D_" uses an optical sampling method. Data output of process and parameter data (electronic type plate) happens digitally via ACURO®link-Protocol. The encoder fulfills the specifications for safety technique according to SIL 3 and category 3, PL e. The motor temperature is transmitted digitally.

Singleturn

The singleturn design "S_" allows absolute, indirect position recording within one mechanical motor rotation.

Multiturn

The multiturn design "M_" allows absolute, indirect position recording within 4096 mechanical motor rotations.

Technical data of encoder

Table 7: Encoder

Technical data motor encoder												
Designation	Symbol	Unit	BASIC		STANDARD		ADVANCED				HIGH	
			AM	AS	BM	BS	CM	CS	HM	HS	DM	DS
Encoder interface	-	-	HIPERFACE®				ACURO®-link					
Encoder signal periods	~/ f	-	16		128		-					
Functional encoder resolution (singleturn)		-	-				20 bit				24 bit	
Distinguishable rotations	U _{turn}	-	4,096	1	4,096	1	4,096	1	4,096	1	4,096	1
System accuracy of encoder ¹	◄	"	±520		±120		± 36				± 20	
Encoder output signal	V _{out}		1V _{ss}				-					
Encoder voltage supply	V _{CC} _{Encoder}	V	7...12									
Encoder max. current consumption	I _{Encoder}	mA	50		60				130			
Functional safety												

Technical data motor encoder												
Designation	Symbol	Unit	BASIC		STANDARD		ADVANCED				HIGH	
			AM	AS	BM	BS	CM	CS	HM	HS	DM	DS
Safety integrity level		-	-		SIL 2				SIL 3			
Performance level		-	-		Category 3, PL d				Category 3, PL e			
Position resolution for safe position		-		-					9 bit			
SAFETY ON BOARD												
1) The installation mechanics can sporadically influence the accuracy of the overall system.												

Technical data of encoder

For more information about Integrated Safety technology and the requirements to use motors with encoder systems for Safety technology applications, please refer to the documentation about the drive controller.

Available motor encoder according to motor frame size

Table 8: MS2N Motor encoder - Availability according to motor frame size

Motor frame size	Encoder									
	AM	AS	BM	BS	CM	CS	HM	HS	DM	DS
MS2N03	●	●	●	●	●	●	●	●	-	-
MS2N04	●	●	●	●	●	●	●	●	-	-
MS2N05	●	●	●	●	●	●	●	●	-	-
MS2N06	●	●	●	●	●	●	-	-	●	●
MS2N07	●	●	●	●	●	●	-	-	●	●
MS2N10	●	●	●	●	●	●	-	-	●	●
MS2N13	●	●	●	●	●	●	-	-	●	●
● available - not available										

Available connection technology for MS2N encoder

Table 9: MS2N Motor encoder - Electrical connection (available options)

Connection technique	Encoder									
	AM	AS	BM	BS	CM	CS	HM	HS	DM	DS
Single cable connection (H, S)	-	-	-	-	●	●	●	●	●	●
Double cable connection (A, B, C, D, E, T, U, V)	●	●	●	●	●	●	●	●	●	●
● available - not available										

4.8 Degree of protection

The protection type according to EN 60034-5 is determined by the abbreviation IP (International Protection) and two code numbers for the degree of protection. The first code number stands for the degree of protection against contact and ingress of foreign bodies. The second code number stands for the degree of protection against ingress of water.

Standard motors (specification according to type plate)

- IP64 without shaft sealing ring
- IP65 with radial shaft sealing ring
- IP67 with shaft sealing ring and sealing air connection

Additional specifications (not on type plate)

- Motors with fan
 - IP65 fan motor
 - IP2X safety fence fan propeller

4.9 Output shaft, balancing and extension elements

4.9.1 Shaft end

Options according to type code

Shaft	Type
Smooth, without shaft sealing ring	H
Smooth, with shaft sealing ring	G
Keyway, without shaft sealing ring	L
Keyway, with shaft sealing ring	K

Smooth shaft

Cylindrical shaft end according to DIN 748-3 with frontal centering hole with "DS" thread according to DIN 332-2.

The standard design for a non-positive shaft-hub connection without play and excellent smooth running. Use clamping sets, pressure sleeves or clamping elements for coupling the machine elements to be driven.

Shaft with keyway

Cylindrical shaft end according to DIN 748-3 with frontal centering hole with "DS" thread according to DIN 332-2 and keyway.

The keyway design allows form-locking transmission of torques with constant direction and low requirements on the shaft-hub connection.

The machine elements to be driven have to be secured in axial direction via the centering hole.

Type	Key DIN 6885-A	Centering hole DIN 332 Part 2
MS2N03-B	3 × 3 × 14	DS M3
MS2N03-D	4 × 4 × 16	DS M4
MS2N04	5 × 5 × 20	DS M5
MS2N05	6 × 6 × 32	DS M6
MS2N06	8 × 7 × 40	DS M8
MS2N07	10 × 8 × 45	DS M10
MS2N10	10 × 8 × 70	DS M12
MS2N13	14 × 9 × 80	DS M16



Remark

Keys are not included in the scope of delivery.

The design with shaft sealing ring is optional. The shaft sealing ring affects the degree of protection → [Chapter 4.8 Degree of protection on page 27](#). We recommend regular visual inspections on shaft sealing rings. Depending on operating conditions, signs of wear may appear after 5,000 operating hours. If necessary, replace the shaft sealing rings.



Remark

Bosch Rexroth recommends to have these repairs made by Bosch Rexroth Service.

4.9.2 Balancing

MS2N motors with keyway are balanced with "half key" (half key balancing acc. to DIN ISO 21940-32).

The type of balancing is specified at the shaft front end or the base of the recess with " H " for half key balancing.

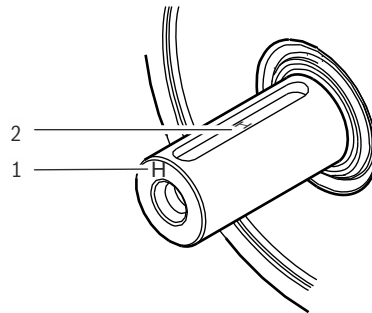

Fig. 4: Identification balancing

- 1 Identification of balancing at the end face of the shaft
- 2 Identification of balancing in the base of the recess

4.9.3 Attachment of drive elements

The mode of balancing of drive elements must be adjusted to the motor. Observe the notes about mounting drive elements.

▲ CAUTION

Ingressing fluid may damage the motor!

Fluids (e.g., cooling lubricants, gear oil, etc.) may not be present at the output shaft.

When attaching gearboxes, only use gearboxes with a closed (oil-tight) lubrication system. Gearbox oil should not be in permanent contact with the shaft sealing ring of the motors.

Gearbox mounting on motors

The Rexroth gearbox series GTE and GTM are intended for installation at MS2N motors. Refer to the notes regarding the motor and gearbox configuration in [Chapter 6.6 Characteristic curve in gearbox mounting on page 57](#).

Observe the instructions in the corresponding manufacturer's documentation.

Overdetermined bearing

When installing drive elements, avoid overdetermined bearing, as impermissibly high bearing reactions can be generated due to unfavorable bearing ratios.



Remark

If an overdetermined arrangement of bearings cannot be avoided, please contact Bosch Rexroth.

Couplings

The machine construction and the drive elements used must be carefully adapted to the motor type so as to make sure that the load limits of the shaft and the bearing are not exceeded.



Remark

When extremely stiff couplings are attached, the revolving radial force may cause an impermissibly high load on the shaft and bearing.

Bevel gear pinion or helical drive pinion

Due to thermal expansion, the DE side of the drive shaft can be displaced by up to 0.6 mm in relation to the motor housing. If helical drive pinions or bevel gear pinions directly attached to the output shaft are used, this change in the lengths will lead to

- a shift in the position of the axis, if the driving pinions are not axially fixed on the machine side.
- a thermally dependent component of the axial force, if the driving pinions are axially fixed on the machine side. This causes the risk of exceeding the maximum permissible axial force or of the gear backlash increasing to an impermissible degree.
- damage of the NDE bearing by exceeding the maximum permissible axial force.



Remark

It is recommended to use drive elements with integrated bearings and mount them on the motor shaft via axially compensating couplings.

4.10 Direction of rotation

The direction of rotation of Bosch Rexroth motors is defined according to EN 60034-8 for **clockwise rotation**. When looking at the shaft end (DE) and in the direction of view (NDE), the direction of rotation is clockwise (clockwise sense of rotation) when L1 - U, L2 - V, L3 - W are connected in phase according to the connection diagram.

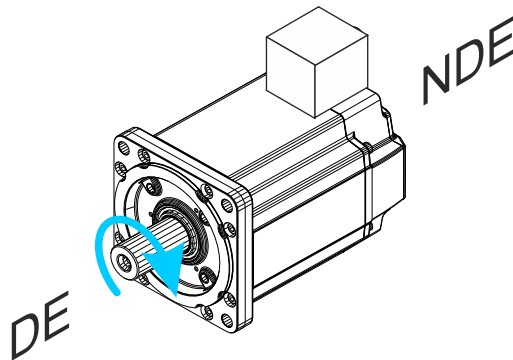

Fig. 5: Direction of rotation

4.11 Holding brake

MS2N motors can optionally be provided with permanent magnet brakes. The backlash-free holding brakes are operated according to the “electrically-released” principle (closed-circuit principle) and open upon applying the switching voltage.

- Number of operating cycles $\geq 5,000,000$
- The holding brakes with emergency stop function are intended to secure motor shafts at standstill. **The holding brakes are no operation brakes to decelerate motors in operation from speed.**
- In case of an emergency stop or voltage drop, the brake operation is only allowed to a limited extend. Up to 500 breaking cycles from speed 3000 1/min can be performed, whereas the maximum switched energy per emer-

gency stop of the brake must not be exceeded. The number of brake applications per hour is 20, whereas a uniform scheduling is a precondition. For specifications about the max. switched energy per emergency stop, see [Chapter 4.11.1 Technical data holding brakes on page 31](#)

▲ CAUTION	Malfunctions due to wear Impermissibly high wear due to breaking from speed by exceeding the specified emergency stop properties. Avoid deceleration from speed during setup mode.
------------------	-------------------------------------------------------------------------------------------------------------------------------------------------------------------------------------------------

The rated voltage to apply the brakes is 24 V DC ±10%.

The voltage supply of the holding brake has to be designed so as to guarantee under the worst installation and operation conditions that a sufficient voltage **24 V DC ±10%** is available at the motor in order to release the holding brake.

The voltage drop ΔU on the brake supply can approximately be calculated for copper conductors using the following formula:

$$\Delta U = \rho_{Cu} \cdot \left(\frac{2 \cdot l}{q} \right) \cdot I_N$$

Fig. 6: Voltage drop of brake supply for Cu (copper) conductor

ΔU Voltage drop [V]

ρ_{Cu} Specific resistance of copper [Ω*mm²/m]

l Cable length [m]

q Wire cross section [mm²]

I_N Rated current [A]

▲ CAUTION	Malfunction in case of exceeded tolerance of the rated voltage (switching voltage) For safe switching of the holding brake, a rated voltage of 24 V DC ±10% is required at the motor. Ensure correct dimensioning of the supply wires (wire length and cross-section) for the holding brake.
------------------	------------------------------------------------------------------------------------------------------------------------------------------------------------------------------------------------------------------------------------------------------------------------------------------------------------------

The control voltage can be reduced using the energy saving function after safely releasing the brake, see [Chapter 4.11.3 Energy saving function for holding brakes on page 34](#).

The holding brakes are intended for direct connection to the Bosch Rexroth controllers. A protective circuit to switch inductive loads of holding brakes is integrated in controllers. Please observe when operating of third-party converters that MS2N motors do not have an integrated protective circuit.

4.11.1 Technical data holding brakes

Holding brakes - Technical data								
Type	Holding torque	Dynamic braking torque	Rated voltage ¹⁾	Rated current	Maximum connection time	Maximum disconnection time	Moment of inertia of the holding brake	Maximum switched energy
	M ₄	M ₁	U _N	I _N	t ₁	t ₂	J _{br}	W _{max}
	Nm	Nm	V	A	ms	ms	kg*m ²	J
MS2N03-A - - - 1 - - -	1.80	1.3	24	0.46	8	35	0.0000074	300
MS2N03-B - - - 1 - - -	1.80	1.3	24	0.46	8	35	0.0000074	300
MS2N03-D - - - 1 - - -	1.80	1.3	24	0.46	8	35	0.0000074	300
MS2N04-B - - - 1 - - -	5.00	4.5	24	0.63	30	45	0.0000451	400
MS2N04-C - - - 1 - - -	5.00	4.5	24	0.63	30	45	0.0000451	400

Holding brakes - Technical data								
Type	Holding torque	Dynamic braking torque	Rated voltage ¹⁾	Rated current	Maximum connection time	Maximum disconnection time	Moment of inertia of the holding brake	Maximum switched energy
	M ₄ Nm	M ₁ Nm	U _N V	I _N A	t ₁ ms	t ₂ ms	J _{br} kg*m ²	W _{max} J
MS2N04-D - - 1- - -	5.00	4.5	24	0.63	30	45	0.0000451	400
MS2N05-B - - 1- - -	10.00	4.5	24	0.73	30	80	0.0001070	400
MS2N05-C - - 1- - -	10.00	4.5	24	0.73	30	80	0.0001070	400
MS2N05-D - - 1- - -	10.00	4.5	24	0.73	30	80	0.0001070	400
MS2N06-B - - 1- - -	10.00	4.5	24	0.73	30	80	0.0001070	400
MS2N06-C - - 1- - -	10.00	4.5	24	0.73	30	80	0.0001070	400
MS2N06-D - - 2- - -	15.00	11	24	0.75	50	135	0.0001400	888
MS2N06-E - - 2- - -	15.00	11	24	0.75	50	135	0.0001400	888
MS2N07-C - - 1- - -	20.00	12.5	24	0.78	40	100	0.0002550	340
MS2N07-D - - 2- - -	36.00	16.5	24	0.94	60	200	0.0004100	850
MS2N07-E - - 2- - -	36.00	16.5	24	0.94	60	200	0.0004100	850
MS2N10-B - - 1- - -	33.00	16.5	24	0.94	60	200	0.0004100	850
MS2N10-C - - 2- - -	53.00	23	24	1.00	70	220	0.0014700	850
MS2N10-D - - 2- - -	53.00	23	24	1.00	70	220	0.0014700	850
MS2N10-E - - 3- - -	90.00	33	24	1.50	65	250	0.0027000	1470
MS2N10-F - - 3- - -	90.00	33	24	1.50	65	250	0.0027000	1470
MS2N13-B - - 1- - -	115.00	-	24	2.10	100	240	0.005670	4,900
MS2N13-C - - 1- - -	115.00	-	24	2.10	100	240	0.005670	4,900
MS2N13-D - - 1- - -	115.00	-	24	2.10	100	240	0.005670	4,900
MS2N13-E - - 1- - -	115.00	-	24	2.10	100	240	0.005670	4,900
MS2N13-C - - 2- - -	280.00	-	24	1.70	300	350	0.020000	2,000
MS2N13-D - - 2- - -	280.00	-	24	1.70	300	350	0.020000	2,000
MS2N13-E - - 2- - -	280.00	-	24	1.70	300	350	0.020000	2,000

1) Tolerance ± 10%

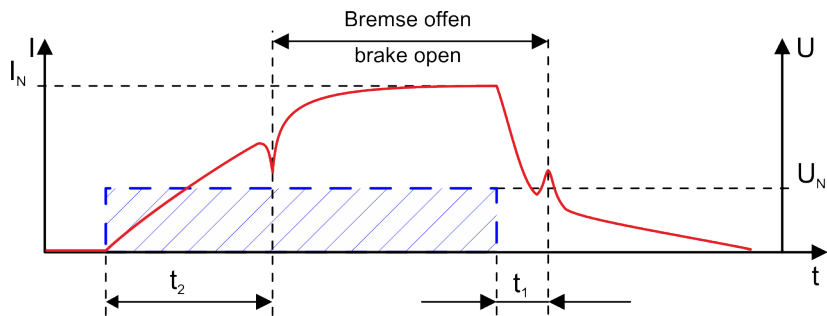

Fig. 7: Switching times of static hold mode
t₁ Connection time (close)
t₂ Disconnection time (open)

4.11.2 Sizing holding brakes

Static sizing

Check if the load torque (M_6) with the available holding torque (M_4) can be held safely. The occurring load torque (M_6) has to be smaller than the holding torque (M_4). In case of unsafe assumed load, use a sufficient safety factor.

$$M_4 \geq S \cdot M_6$$

Fig. 8: Static load torque

M_4 Brake torque [Nm]

M_6 Load torque [Nm]

S Safety factor

Dynamic sizing if emergency stop

In case of an emergency stop, the load torque (M_6) has to be smaller than the minimum dynamic torque (M_1) of the brake. Otherwise the dynamic brake torque is not sufficient to set the axis to standstill.

$$M_1 \geq S \cdot M_6$$

Fig. 9: Dynamic load torque

M_1 Dynamic torque [Nm]

M_6 Load torque [Nm]

S Safety factor

If a mass has to be decelerated within a specified time or after a certain distance, the additional mass moment of inertia of the complete system (J_{tot}) has to be taken into consideration.

$$t_{Br} = \frac{J_{ges} \cdot n}{9,55 \cdot (M_1 \pm M_6)}$$

$$J_{ges} = J_{rot} + J_{fremd}$$

Fig. 10: Shutdown time

t_{Br} Deceleration time [s]

n Nominal speed [1/min]

M_1 Dynamic torque [Nm]

M_6 Load torque [Nm]

J_{total} Moment of inertia of complete system [kgm²]

J_{rot} Moment of inertia of motor [kgm²]

J_{for} External inertia [kgm²]

The specified formula refers to idealized, linear correlations and can thus only be used for estimation purposes. A load torque M_6 inhibiting the brake application is displayed with “-”, a brake application supporting the load torque M_6 is displayed with “+”.

Thermal dimensioning

The brake can be thermally overexerted due to multiple repetitive brake applications (breaking capacity).

$$W_{\max} > \frac{M_1}{M_1 - M_6} \cdot \frac{J_{ges} \cdot n^2}{182,5}$$

Fig. 11: Maximum switched energy
 W_{\max} Maximum switched energy [J]
 n Nominal speed [1/min]
 M_1 Dynamic torque [Nm]
 M_6 Load torque [Nm]
 J_{total} Moment of inertia of complete system [kgm²]

$$P_{\max} > W \cdot z$$

Fig. 12: Maximum switching power
 P_{\max} Maximum switched energy [J]
 W Switching energy [J]
 z Switching operations

4.11.3 Energy saving function for holding brakes

Decrease brake voltage

The control voltage of the holding brake in MS2N holding brakes can be reduced after executing the switching operation Open brake by using control modules (e.g. brake control module HAT02.1-003). By decreasing the control voltage, energy can be saved of up to 50% and the self-heating of the motor can be reduced.

To decrease the control voltage of MS2N holding brakes, the following conditions apply:

- Maximum decrease of control voltage to $U_N \geq 17 V_{DC}$
- Waiting time after releasing the holding brake is at least 200 ms
- Decreasing the control voltage by voltage control or pulse width modulation with a PWM cycle frequency ≥ 4 kHz



Remark

Refer to the instructions in the control module documentation.

Refer to the notes for dimensioning of the cable length and cable cross-section of brake cables.

4.11.4 Holding brakes safety instructions

The permanent magnet brake of a MS2N motor is no safety brake. This means, a torque reduction by non- influenceable disturbance factors can occur. Especially for use in vertical axes.

⚠ WARNING	<p>Grievous bodily harm due to dangerous movements from falling or dropping axes!</p> <p>Secure vertical axes against dropping or sinking after switching off by e.g.:</p> <ul style="list-style-type: none"> - Mechanical locking of the vertical axis - External brake, arrestor, clamping device. - Weight compensation of the axes
------------------	--------------------------------------------------------------------------------------------------------------------------------------------------------------------------------------------------------------------------------------------------------------------------------------------------------------------------------------------------------------------------------

The holding brake itself is not suitable for personal protection. Ensure protection of individuals by superordinate protective measures such as cordoning off of danger zones using protective fences or grids.

For European countries, additionally comply with the following standards and guidelines, e.g.

- EN 954; ISO 13849-1 and ISO 13849-2 Safety-related parts of control units
- Information sheet no. 005 Gravity-loaded axes (vertical axes) published by: DGUV Fachbereich Holz und Metall (German Employer's Liability Insurance Association Wood and Metal)

Determine the safety requirements valid for the case of application and observe the safety requirements during plant design. Comply with national regulations at the installation site of the system.

4.11.5 Holding brake - commissioning and maintenance instructions



That is why the function and the holding brakes have to be checked in regular intervals and malfunctions must be removed in an appropriate period.

The braking effect can be reduced by:

- Corrosion on friction surfaces, vapor and sediment
- Over voltages and too high temperatures
- Wear (increasing the air gap between armature and pole)

The holding brake functionality can be checked mechanically by hand (torque wrench) or automatically by means of the software function.

Manually check holding torque (M4)

1.  Disconnect the motor from the power supply and secure it against being switched on again.
2.  Measure the transferable holding torque (M4) of the holding brake with a torque wrench.

Check holding torque (M4) using the software function

For Bosch Rexroth drive controller

-  Start the P-0-0541, C2100 Command Holding system check in drive controller. The efficiency of the holding brake and the opened state are checked by starting the routine.
 - ➔ If the holding torque (M4) **is not achieved**, the resurfacing routine can be used to reconstitute the holding torque. If you have any questions about grind in parameters, contact Bosch Rexroth service.

4.12 Flange exactness

The properties concentricity, run-out and alignment are defined in the flange accuracy (N, R). By default, MS2N motors are equipped with tolerance N. From frame size 06, the optional design tolerance R is available. The labeling is done in the motor type designation. See also [Chapter 4.9 Output shaft, balancing and extension elements on page 28](#).

4.12.1 Concentricity tolerance of the shaft end

Table 10: Concentricity tolerance regarding the shaft diameter for MS2N motors

Diameter shaft end [d]	Concentricity tolerance in [mm]	
	N	R
9	0.03	0.015
11, 14	0.035	0.018
19, 24	0.04	0.021
32, 38, 48	0.05	0.025

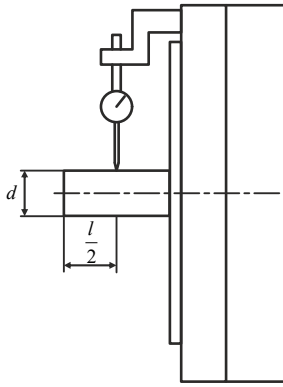

Fig. 13: Measuring system of concentricity tolerance
Measurement takes place in distance $l/2$ (shaft end center), rectangular to the motor flange.

4.12.2 Concentricity and alignment

Table 11: Coaxiality and alignment tolerance related to the centering diameter in MS2N motors

Centering diameter [mm]	Concentricity and alignment tolerance in [mm]	
	N	R
40, 50, 95	0.08	0.04
130, 180	0.1	0.05
250	0.125	0.063

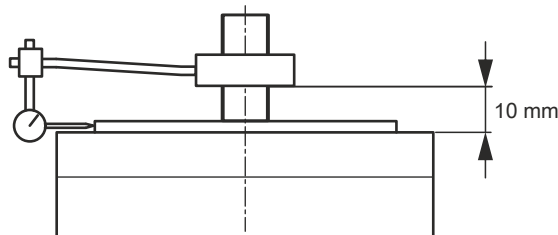

Fig. 14: Measuring system of coaxiality

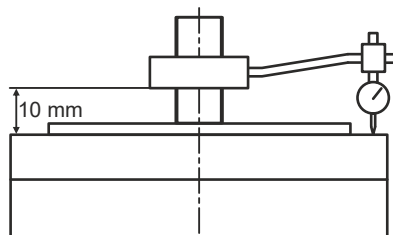

Fig. 15: Measuring system of alignment
The coaxiality and the alignment are measured in vertical motor position to exclude the influence of gravitational forces.

4.13 Vibration behavior

The oscillation behavior corresponds to oscillating quantity level A according to EN IEC 60034-14:2018 up to the rated speed.

4.14 Bearing

The motors are equipped with a deep-groove ball bearing with high-temperature grease for prelubrication.

Table 12: Bearing size MS2N

Type	Bearing size DE	Bearing size NDE	Floating bearing	Fixed bearing
MS2N03	6001	6000	DE	NDE
MS2N04	6003	6001	DE	NDE
MS2N05	6204	6303	DE	NDE
MS2N06	6206	6303	DE	NDE
MS2N07	6207	6205	DE	NDE
MS2N10	6309	6306	DE	NDE
MS2N13	6212	6211	DE	NDE

4.14.1 Bearing service life

The bearing lifetime is an important criterion for the availability of motors. The operating conditions influence the bearing service life L_{10h} considerably.

The following boundary conditions apply to the bearing service life L_{10h} :

- Operation within the specified permissible loads (radial and axial force)
- Operation within the permissible ambient conditions (temperature range 0 ... 40 °C, vibration, and so on).
- Operation within the thermally permissible operating characteristic curve

The bearing lifetime also depends on the service life of the grease. A calculated grease service life was used for the mentioned specifications, taking into consideration the following boundary conditions.

- Horizontal installation
- Low vibration and impact loads
- No oscillating bearing movement $< 180^\circ$
- Mean speed according to [Table 13 Mean speed - basis of calculated grease service life on page 37](#):

Table 13: Mean speed - basis of calculated grease service life

Type	Mean speed
MS2N03, -04, -05, -06	$\leq 3,500$ 1/min
MS2N07	$\leq 3,000$ 1/min
MS2N10	$\leq 2,000$ 1/min
MS2N13	$\leq 1,800$ 1/min

The following standard values apply under the specified preconditions for the 60K and 100K operation modes:

L_{10h} in case of operation after S1-60K

$L_{10h} = 30.000$ h, in case of utilization after S1-60K and max. load factor 95% during the runtime.

L_{10h} in case of operation after S1-100K

$L_{10h} = 20.000$ h, in case of utilization after S1-100K and max. load factor 90% during the runtime.



Remark

When exceeding or not complying with these conditions, a reduced service life is to be expected.

4.14.2 Explanation of radial and axial force

During operation, both radial and axial forces act upon the motor shaft and the motor bearing. The permissible radial force F_R in distance x from the shaft shoulder and the mean speed is specified in the radial force diagrams.

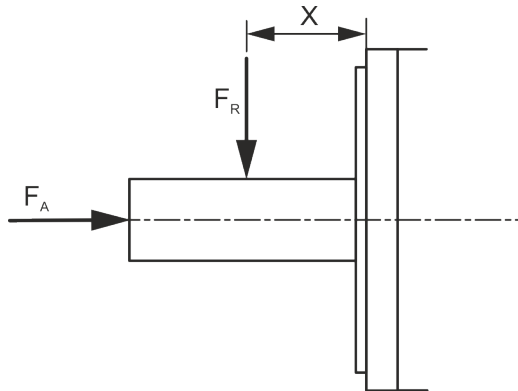

Fig. 16: Point of action of radial force F_R and axial force F_A

The axial force values are the minimum permissible axial forces F_A without limitations. A detailed dimensioning is only possible if more boundary conditions are known:

- Occurring radial force and axial force with force application point
- Installation position (horizontal, vertical with the shaft end pointing to the top or bottom)
- Mean speed

For radial force diagrams, refer to the technical data

MS2N03 → Chapter 7.1.5 MS2N03 Radial force on page 68

MS2N04 → Chapter 7.2.4 MS2N04 Radial force on page 86

MS2N05 → Chapter 7.3.4 MS2N05 Radial force on page 104

MS2N06 → Chapter 7.4.4 MS2N06 Radial force on page 125

MS2N07 → Chapter 7.5.8 MS2N07 Radial force on page 233

MS2N10 → Chapter 7.6.10 MS2N10 Radial force on page 346

MS2N13 → Chapter 7.7.8 MS2N13 Radial force on page 407

4.15 Frame size, installation type

The motors can be installed horizontally and vertically with the shaft end pointing to the top or bottom. The mounting variants comply with the IM code according to EN 60034-7:1993 + A1:2001 for design and installation type.

Code I / Code II (EN 60034-7)		
IM B5 / IM 3001		Flange attachment on the drive side of the flange
IM B35 / IM 2001 (only MS2N13)		Foot installation, feet below, with additional flange mounting on drive side of the flange

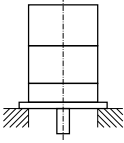
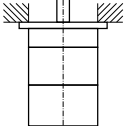
Code I / Code II (EN 60034-7)		
IM V1 / IM 3011		Flange attachment on the drive side of the flange, drive side facing down
IM V3 / IM 3031		Flange attachment on the drive side of the flange, drive side facing up

Avoid liquid at the drive shaft or the shaft sealing ring in case of vertical installation according to IM V3. For further information regarding the protection class, see [Chapter 4.8 Degree of protection on page 27](#).

4.16 Coating

One-layer standard varnish (1K), water-based, in conductive form, RAL9005 jet black

An additional varnish with a coat thickness of max. 40 µm is allowed.

Protect all safety notes (stickers), type plates and open connectors with a painting protection when painting additionally.

4.17 Air-pressure connection

A defined over pressure can be conducted into the motor with an air-pressure connector kit. Therewith, penetration of damaging liquids can be prevented. The areas of application for sealing air are all installation locations in which humid air or coolant can come into direct contact with the motors, especially in wet processing rooms.

NOTICE

Damage due to permanent existing liquid on the shaft sealing ring!

The use of sealing air does **not** prevent the penetration of continuously existing liquid on the shaft sealing ring (e.g. for open gearboxes). Due to capillary action, gearbox oil can penetrate into the motor and damage it, despite using sealing air.

The pressure air must be free from oil and dry, according to DIN ISO 8573-1 Class 3 (usually in pressure air nets).

Table 14: Specification pressure air for sealing air application

Designation	Value
Operating pressure	0.1 ± 0.05 bar
Max. relative humidity	20...30 %
Air	dry, free from dust and oil (DIN ISO 8573-1 Class 3)
Necessary compressed air hose	4 × 0.75 (not included in the scope of delivery)

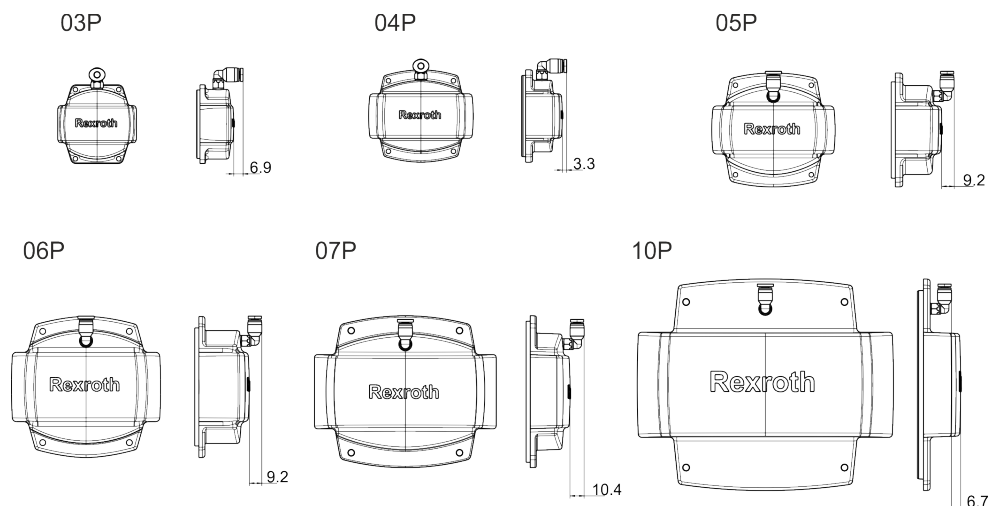

Fig. 17: Sealing air connection variants

Table 15: Total length of motor with sealing air connection

Motor	Connection, rotatable	Total length [mm]	S [mm]
MS2N03	03P	L + 15 + S	6.9
MS2N04	04P	L + 15 + S	3.3
MS2N05	05P	L + 18 + S	9.2
MS2N06	06P	L + 18 + S	9.2
MS2N07	07P	L + 16 + S	10.4
MS2N10	10P	L + 16	-

L: See specifications length table "L"

NOTICE	<p>Damage due to ingress of dirt!</p> <p>The compressed air gland is not closed upon delivery. Always operate motors with compressed air connection with connected compressed air supply.</p>
---------------	------------------------------------------------------------------------------------------------------------------------------------------------------------------------------------------------------

Further information → [Chapter 10 Sealing air connection on page 441.](#)

4.18 Additional ground connection

For MS2N motors, an additional grounding connection is provided. The availability is specified in the product type code under the entry Other designs "E".

Preassembled motor connection cable (with PE conductor) can be used for the grounding concept at the machine as the requirements of the machine grounding according to DIN EN 60204-1 have to be met. The machine manufacturer is responsible for system safety and for compliance with the installation instructions. The superordinate protection devices such as the switch off characteristics of safety devices and loop impedences have to be taken into consideration. Due to an insufficient machine grounding, the option additional grounding connection can be used to directly attach a ground connection at the motor.

4.19 Noise emission

The typical sound pressure level $L_p(A)$ is specified for the speed range 0 rpm up to the rated speed. The installation situation affects the noise emission.

5 Type codes

5.1 MS2N03 Type code

Features

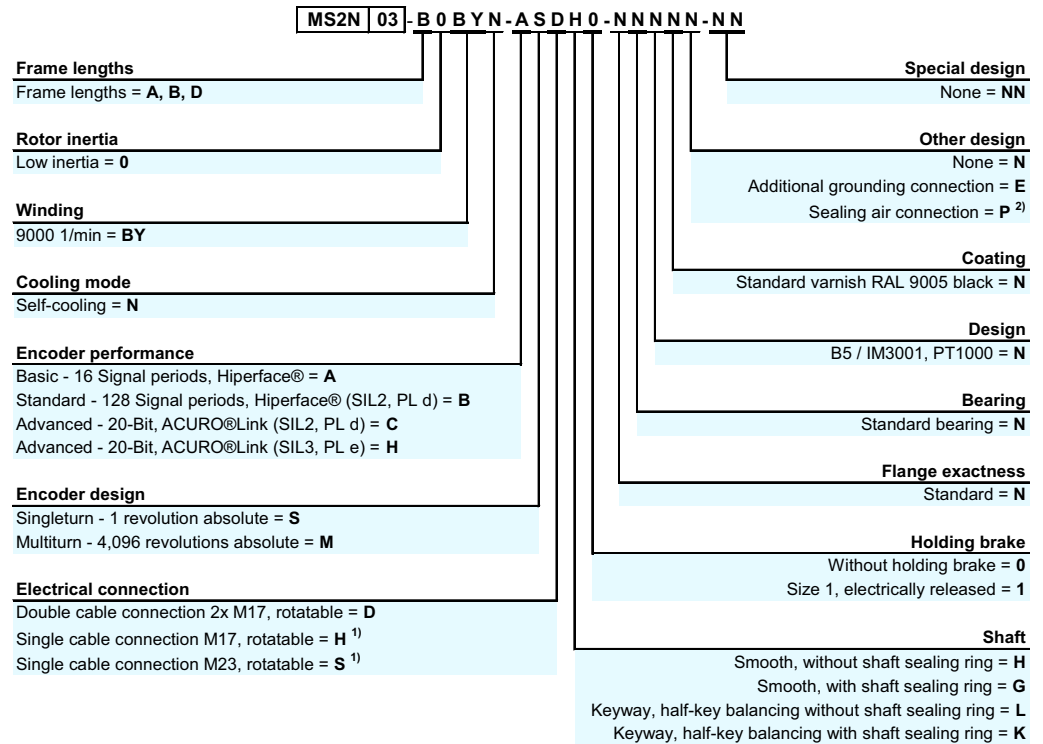

1) Electrical connection "S" and "H" only available with encoder performance "C" and "H"

2) Other design "P" only available with electrical connection "S" and shaft "G" or "K"

Option N

• available — not available

Cooling mode N - Self cooling			Encoder performance				Electrical connection		
Frame lengths	Rotor inertia	Winding	A	B	C	H	D	S ^{b)}	H ^{b)}
A	0	BY	—	—	•	•	—	—	•
B	0	BY	•	•	•	•	•	•	•
D	0	BY	•	•	•	•	•	•	•

b) Electrical connections "S" and "H" are only available with encoder performance "C" or "H"

5.2 MS2N04 Type code

Features

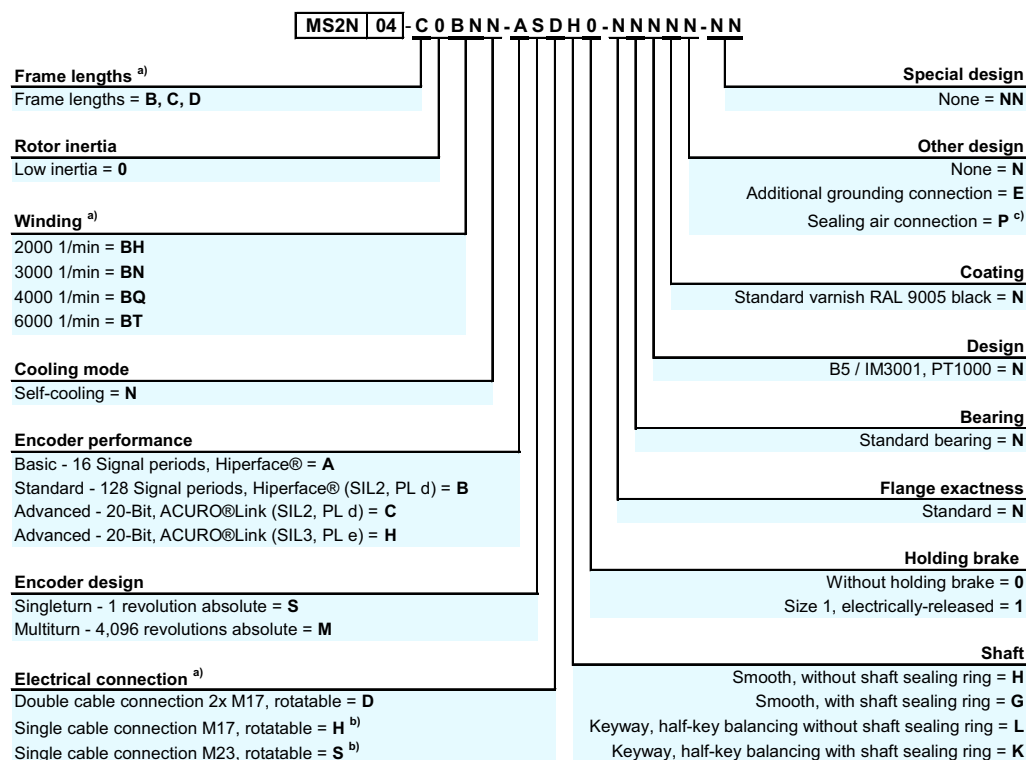

a) For available standard options refer to the following table

b) Electrical connections "H" and "S" only available with encoder performance "C" and "H"

c) Other design "P" only available with electrical connection "S" and shaft "G" or "K"

Option self-cooling

available not available

Cooling mode N - Self-cooling			Electrical connection		
Frame length	Rotor inertia	Winding	D	H ^{b)}	S ^{b)}
B	0	BN	•	•	•
		BT	•	•	•
C	0	BN	•	•	•
		BT	•	•	•
D	0	BH	•	•	•
		BQ	•	•	•

5.3 MS2N05 Type code

Features

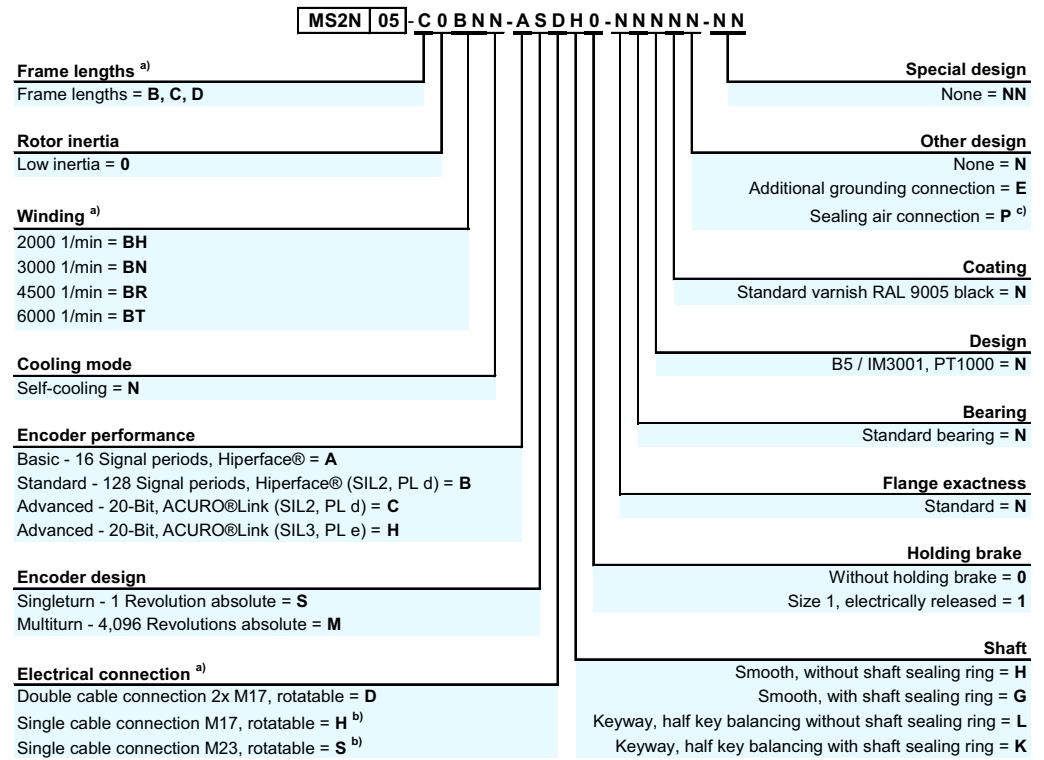

a) For available standard options refer to the following table

b) Electrical connections "H" and "S" only available with encoder performance "C" and "H"

c) Other design "P" only available with electrical connection "S" and shaft "G" or "K"

Option self-cooling

available not available

Cooling mode N - Self-cooling			Electrical connection		
Frame length	Rotor inertia	Winding	D	H ^{b)}	S ^{b)}
B	0	BN	•	•	•
		BT	•	•	•
C	0	BN	•	•	•
		BT	•	•	•
D	0	BH	•	•	•
		BQ	•	•	•

5.4 MS2N06 Type code

Features

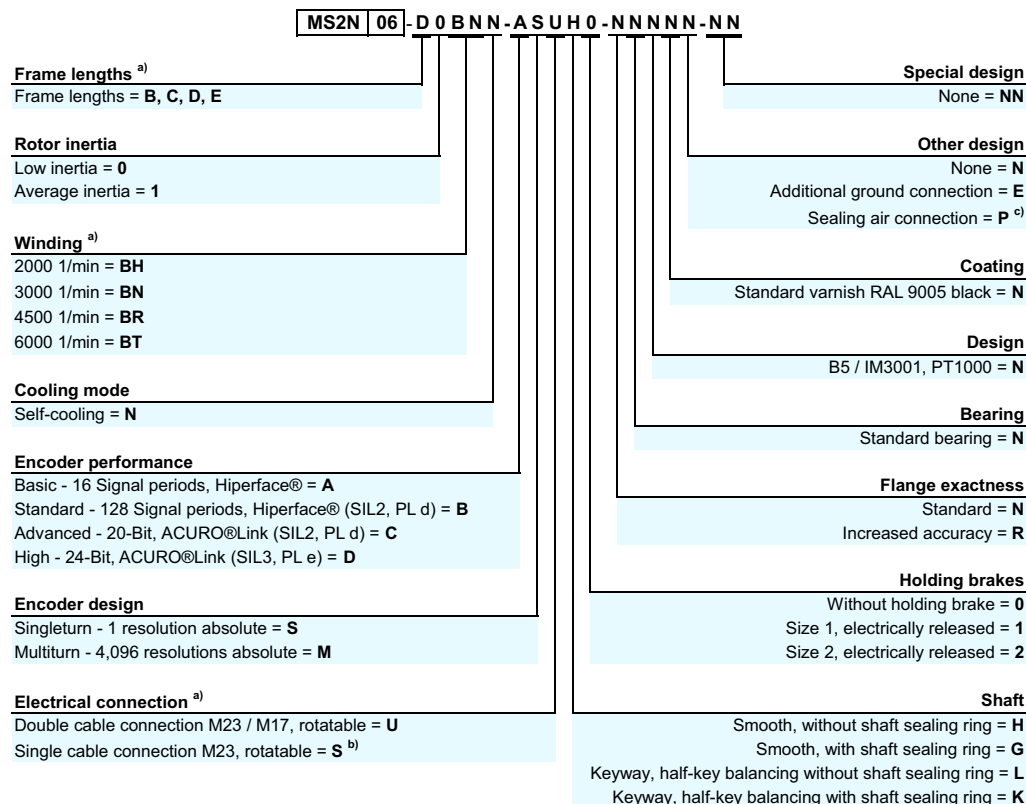

- a) For available standard options refer to the following table
b) Electrical connection "S" only available with encoder performance "C" and "H"
c) Other design "P" only available with shaft "G" or "K"

Options self-cooling

available not available

Cooling mode N - Self-cooling			Electrical connection		Holding brake		
Frame length	Rotor inertia	Winding	U	S ^{b)}	0	1	2
B	1	BN	•	•	•	•	-
C	0	BN	•	•	•	•	-
		BT	•	•	•	•	-
D	0	BN	•	•	•	-	•
		BR	•	•	•	-	•
E	0	BN	•	•	•	-	•
		BR	•	•	•	-	•

5.5 MS2N07 Type code

Features

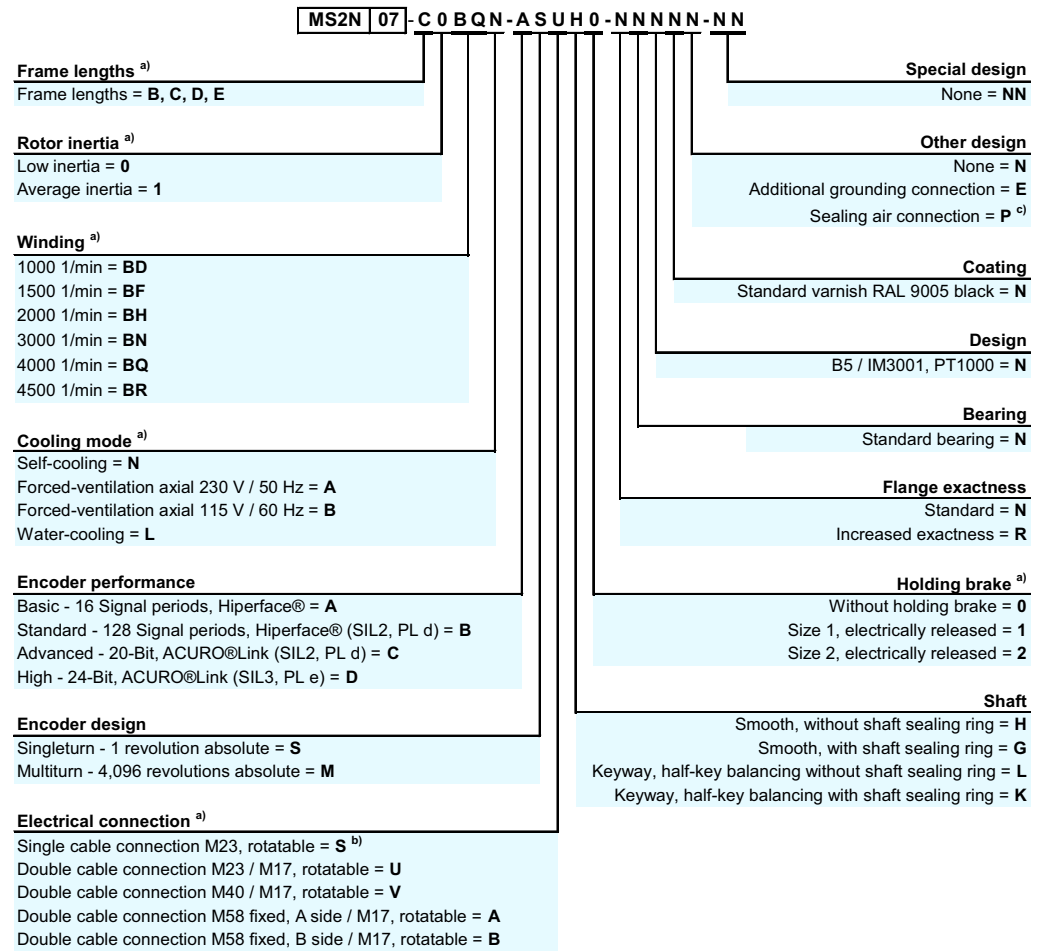

- a) For available standard options refer to the following table
b) Electrical connection "S" only available with encoder performance "C" and "D"
c) Other design "P" only available with shaft "G" or "K"

Options self-cooling

• available - not available

Cooling mode N - Self-cooling			Electrical connection			Holding brake		
Frame length	Rotor inertia	Winding	S ^{b)}	U	V	0	1	2
B	1	BN	•	•	-	•	•	-
		BN	•	•	-	•	•	-
C	0	BQ	•	•	-	•	•	-
		BN	•	•	-	•	•	-
	1	BR	•	•	-	•	•	-
		BR	•	•	-	•	•	-
D	0	BF	•	•	-	•	-	•
		BH	•	•	-	•	-	•
		BN	•	•	-	•	-	•
		BR	-	-	•	•	-	•
	1	BF	•	•	-	•	-	•
		BH	•	•	-	•	-	•
		BN	•	•	-	•	-	•
		BN	•	•	-	•	-	•
E	0	BD	•	•	-	•	-	•
		BH	•	•	-	•	-	•
		BN	-	-	•	•	-	•
		BQ	-	-	•	•	-	•
	1	BD	•	•	-	•	-	•
		BH	•	•	-	•	-	•
		BN	-	-	•	•	-	•
		BN	-	-	•	•	-	•

Options forced ventilation

available not available

Cooling mode A/B - Forced-ventilation			Electrical connection		Holding brake		
Frame length	Rotor inertia	Winding	U	V	0	1	2
C	0	BN	-	•	•	•	-
		BQ	-	•	•	•	-
	1	BN	-	•	•	•	-
		BR	-	•	•	•	-
D	0	BF	-	•	•	-	•
		BH	-	•	•	-	•
		BN	-	•	•	-	•
		BR	-	•	•	-	•
	1	BF	-	•	•	-	•
		BH	-	•	•	-	•
E	0	BD	-	•	•	-	•
		BH	-	•	•	-	•
		BN	-	•	•	-	•
		BQ	-	•	•	-	•
	1	BD	-	•	•	-	•
		BH	-	•	•	-	•
		BN	-	•	•	-	•
		BR	-	•	•	-	•

Options water cooling

available not available

Cooling mode L - Water cooling			Electrical connection		Holding brake		
Frame length	Rotor inertia	Winding	V	A/B	0	1	2
C	0	BN	•	-	•	•	-
		BQ	•	-	•	•	-
	1	BN	•	-	•	•	-
		BR	•	-	•	•	-
D	0	BH	•	-	•	-	•
		BN	•	-	•	-	•
	1	BR	-	•	•	-	•
		BH	•	-	•	-	•
E	0	BN	•	-	•	-	•
		BQ	-	•	•	-	•
	1	BH	•	-	•	-	•
		BN	-	•	•	-	•

5.6 MS2N10 Type code

Features

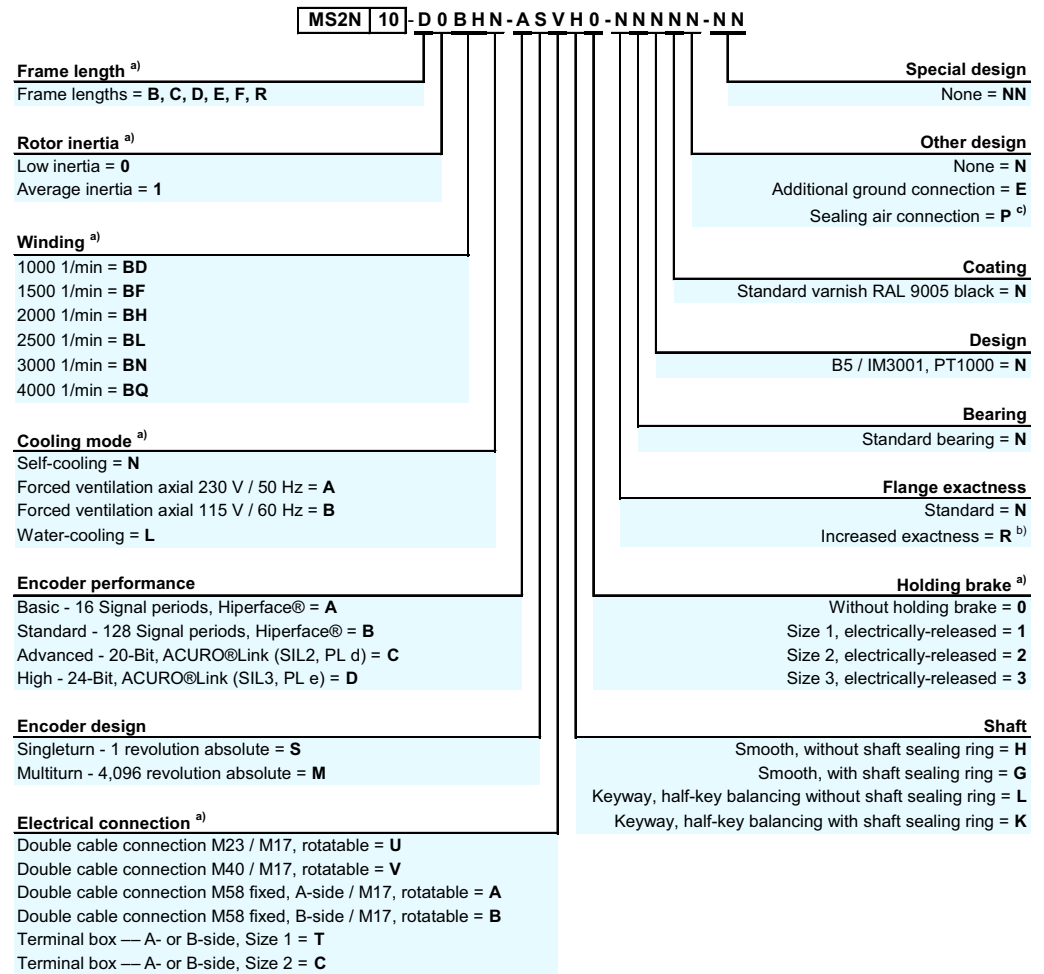

a) For available standard options refer to the following table

b) Flange exactness "R" only available with frame lengths "C", "D", "E" and "F"

c) Other design "P" only cooling mode "N" or "L" and shaft "G" or "K" and electrical connections "U", "V", "A", "B"

Options self-cooling

• available - not available

Cooling mode N - Self-cooling			Electrical connection			Holding brake			
Frame length	Rotor inertia	Winding	U	V	A/B	0	1	2	3
B	1	BQ	•	•	-	•	•	•	-
		BH	-	•	-	•	-	•	-
C	0	BN	-	•	-	•	-	•	-
		BH	-	•	-	•	-	•	-
	1	BN	-	•	-	•	-	•	-
		BH	-	•	-	•	-	•	-
D	0	BN	-	•	-	•	-	•	-
		BH	-	•	-	•	-	•	-
	1	BF	-	•	-	•	-	•	-
		BN	-	•	-	•	-	•	-
E	0	BH	-	•	-	•	-	-	•
		BN	-	-	•	•	-	-	•
	1	BF	-	•	-	•	-	-	•
		BN	-	-	•	•	-	-	•
F	0	BD	-	•	-	•	-	-	•
		BH	-	-	•	•	-	-	•
	1	BD	-	•	-	•	-	-	•
		BH	-	-	•	•	-	-	•
R	0	BQ	-	-	•	•	-	-	•

Options forced ventilation

• available - not available

Cooling mode A/B - Forced ventilation			Electrical connection			Holding brake		
Frame length	Rotor inertia	Winding	V	A/B	T	0	2	3
C	0	BH	•	-	•	•	•	-
		BN	•	-	•	•	•	-
	1	BH	•	-	-	•	•	-
		BN	•	-	-	•	•	-
D	0	BH	•	-	•	•	•	-
		BN	-	•	•	•	•	-
	1	BF	•	-	-	•	•	-
		BN	-	•	-	•	•	-
E	0	BH	-	•	•	•	-	•
		BN	-	•	•	•	-	•
	1	BF	•	-	-	•	-	•
		BN	-	•	•	•	-	•
F	0	BD	•	-	•	•	-	•
		BH	-	•	•	•	-	•
	1	BD	•	-	-	•	-	•
		BH	-	•	•	•	-	•
R	0	BL	-	•	•	•	-	•

Options water cooling

• available - not available

Cooling mode L -Water-cooling			Electrical connection			Holding brake		
Frame length	Rotor inertia	Winding	A/B	T	C	0	2	3
C	0	BH	•	•	-	•	•	-
		BN	•	•	-	•	•	-
	1	BH	•	-	-	•	•	-
		BN	•	-	-	•	•	-
D	0	BH	•	•	-	•	•	-
		BN	•	•	-	•	•	-
	1	BF	•	-	-	•	•	-
		BN	•	-	-	•	•	-
E	0	BH	•	•	-	•	-	•
		BN	•	-	•	•	-	•
	1	BF	•	-	-	•	-	•
		BN	•	-	-	•	-	•
F	0	BH	•	-	•	•	-	•
	1	BD	•	-	-	•	-	•
		BH	•	-	-	•	-	•
R	0	BL	•	-	-	•	-	•
		BQ	-	-	•	•	-	•

5.7 MS2N13 Type code

Features

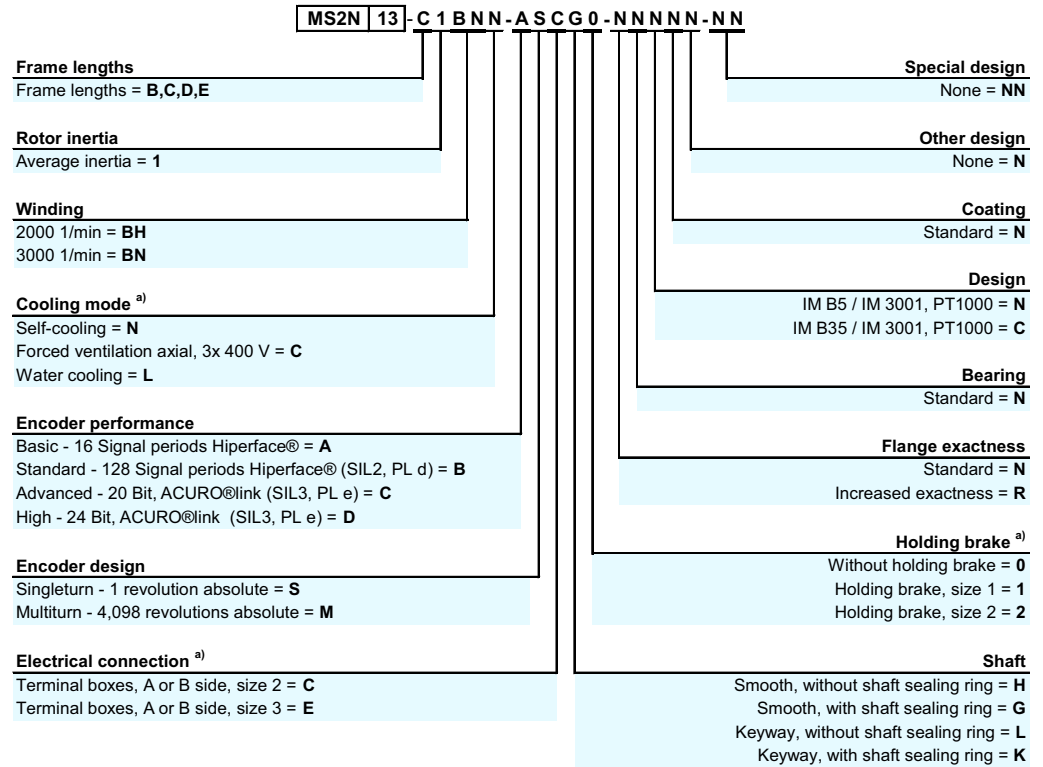

a) For available standard options refer to the following table

Options self-cooling

• available - not available

Cooling mode N - Self-cooling			Electrical connection		Holding brake		
Frame lengths	Rotor inertia	Winding	C	E	0	1	2
B	1	BH	•	-	•	•	-
		BN	•	-	•	•	-
C	1	BH	•	-	•	-	•
		BN	•	-	•	-	•
D	1	BH	-	•	•	-	•
		BN	-	•	•	-	•
E	1	BH	-	•	•	-	•
		BN	-	•	•	-	•

Options forced ventilation

• available - not available

Cooling mode C - Forced ventilation			Electrical connection		Holding brake		
Frame lengths	Rotor inertia	Winding	C	E	0	1	2
B	1	BH	•	-	•	•	-
		BN	•	-	•	•	-
C	1	BH	•	-	•	-	•
		BN	•	-	•	-	•
D	1	BH	-	•	•	-	•
		BN	-	•	•	-	•
E	1	BH	-	•	•	-	•
		BN	-	•	•	-	•

Options water cooling

available not available

Cooling mode L - Water-cooling			Electrical connection		Holding brake		
Frame lengths	Rotor inertia	Winding	C	E	0	1	2
B	1	BH	•	-	•	•	-
		BN	•	-	•	•	-
C	1	BH	•	-	•	•	-
		BN	•	-	•	•	-
D	1	BH	-	•	•	•	-
		BN	-	•	•	•	-
E	1	BH	-	•	•	•	-
		BN	-	•	•	•	-

6 Operating areas and characteristic curves

6.1 Operating area

The permissible operating ranges for MS2N motors are defined for ambient temperatures of 0 ... 40 °C and installation altitudes up to 1000 m above MSL. The operating areas are characterized by characteristic curve fields according to .

- Limit curves (intermitted operation, voltage limit without/with field weakening)
- S1-100 K continuous operation curve (overtemperature 100 K at the winding)
- S1-60 K continuous operation curves (overtemperature 60 K at the housing)

The individual characteristic curves are described in the following figure.

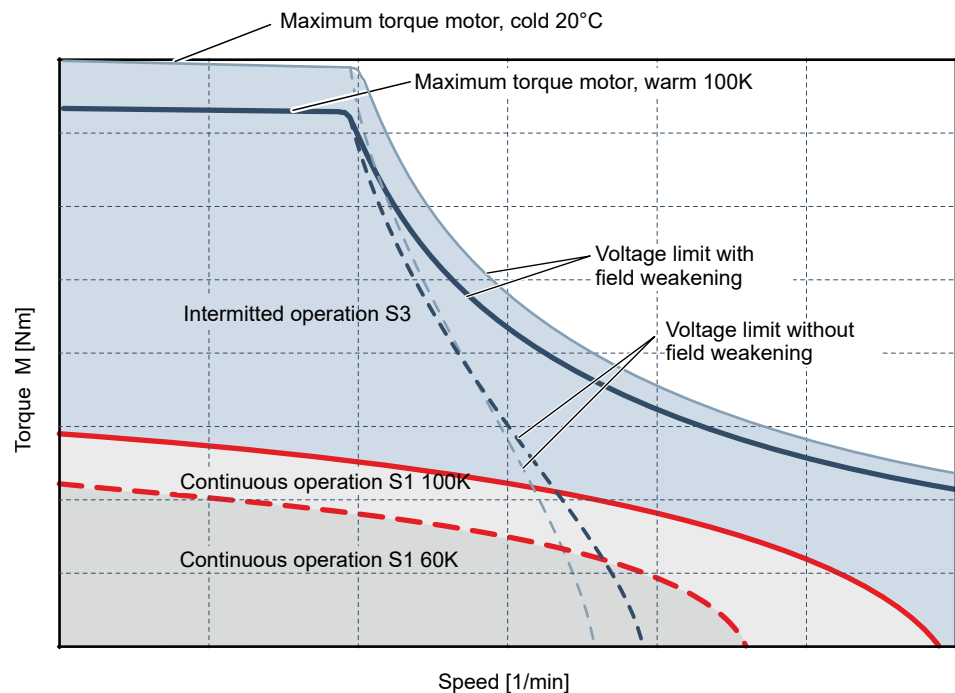

Fig. 18: Operating area of MS2N motors

The thermal motor installation determines the degree of power loss, discharged via the flange. The rated data for 100K and 60K specified in the technical data apply to the following installation conditions:

Table 16: Installation conditions for utilization according to the specified characteristic curves

Type	100 K data (not thermally insulated)	60 K data (thermally insulated) ¹
	Steel plate L x W x H [mm]	Aluminum plate L x W x H [mm]
MS2N03, -04	100 x 220 x 40	140 x 210 x 10
MS2N05, -06	350 x 350 x 30	300 x 240 x 15
MS2N07, -10	450 x 370 x 30	300 x 270 x 15
MS2N13	450 x 370 x 30	-

- 1) insulated with laminated paper FR-2, material thickness 2 mm



Remark

In case of ambient temperatures above 40 °C and installation altitudes of 1000 m above MSL, the high performance data have to be reduced .

6.1.1 Continuous operation S1

The S1-100 K characteristic curve represents the permissible limits of motor winding during continuous operation. For a lower thermal utilization, e.g.

- in case of unfavorable harnessing of heat of the flange mounting
- in order to limit the housing temperature to 100 °C
- in order to avoid unfavorable heating of the machine by the motor
- in order to increase the motor (e.g. motor/encoder bearing) reliability

Bosch Rexroth recommends to select the S1-60K characteristic curve. The characteristic curves are specified for S1-100K and S1-60K. The motor utilization is predominantly influenced by the installation situation.

NOTICE

Property damage due to thermal overload

Motors in continuous operation application must not be operated above the specified characteristic curve limits S1-60 K or S1-100 K.

6.1.2 Periodic intermitted operation S3

During periodic intermittent operation, the motor can tolerate a higher load depending on the ON time.

6.1.3 Operation in field weakening

Field weakening operation of MS2N motors is possible with ctrlX and Indra-Drive controllers.

6.1.4 Motor torque during operation at standstill

In applications such as joining or press machines, where motors have to produce torque continuously asymmetrical currents when the motor is in standstill (close angular range) will flow in the motor windings. This can result in motor overload during continuous operation. The values specified in the data sheet have to be reduced according to the following table. The continuous torque that can be output at standstill M_0^* can be calculated by multiplying the data sheet values with the subsequent reduction factors F_0 .

$$M_0^* = F_0 \cdot M_0$$

Reduction factor F_0

Table 17: Reduction factor F_0

Type	Cooling type	Frame length							
		A	B	C	D	E	F	R	
MS2N03	Self-cooling 60K	0.87	0.95		-	-	-		
	Self-cooling 100K	0.84	0.85						
MS2N04, -05	Self-cooling 60K	-	0.95		-	-	-		
	Self-cooling 100K		0.85						
MS2N06	Self-cooling 60K		0.88	0.95					
	Self-cooling 100K		0.85	0.85					
MS2N07	Self-cooling 60K		0.88	0.95					
	Self-cooling 100K		0.85	0.85					
	Forced ventilation		-	0.80					
	Water cooling			0.72					
MS2N10	Self-cooling 60K		0.82	0.88	0.95			0.92	
	Self-cooling 100K		0.80	0.82	0.85			0.85	
	Forced ventilation		-	0.80					
	Water cooling			0.72					
MS2N13	Self-cooling 60K		0.88	0.90	0.92	-	-		
	Self-cooling 100K		0.82	0.83	0.85	-	-		
	Forced ventilation		0.78		0.80	-	-		
	Water cooling		0.72						

6.2 Characteristic curves for DC bus voltage

The technical data sheets contain characteristic curves for two typical DC bus voltages. Depending on the DC bus voltage, the characteristic curves result.



Remark

S1 continuous operation curves depend on the DC bus voltage. The rated data specified on the nameplate are defined for the operating case with U_{ZK2} (compare Fig. 19).

The characteristic curve apply to:

Table 18: DC bus voltages

Controller	Line voltage	DC bus
ctrlX	3 × 400 V (U_{ZK1})	uncontrolled
IndraDrive	3 × 400 ... 480 V (U_{ZK2})	controlled

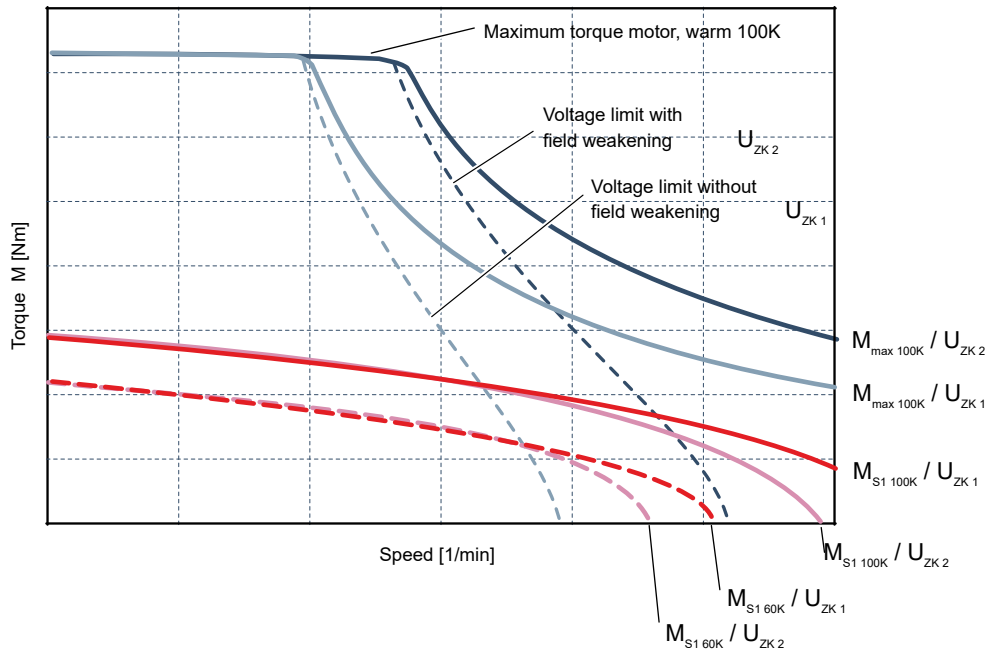

Fig. 19: Characteristic curve specifications

The specified characteristic curves are typical standard values. The actual performance data of a drive axis are subject to manufacturing-related tolerances.

6.3 Rated data

Rated data are defined for the following conditions:

- Rated speed is determined by the DC bus voltage U_{ZK1} . The voltage limit or the point of optimal performance are relevant variables to specify the rated speed.
- Rated data are applied to the rated speed and to the S1 continuous operation characteristics at $M_{S1\ 100K} / U_{ZK2}$

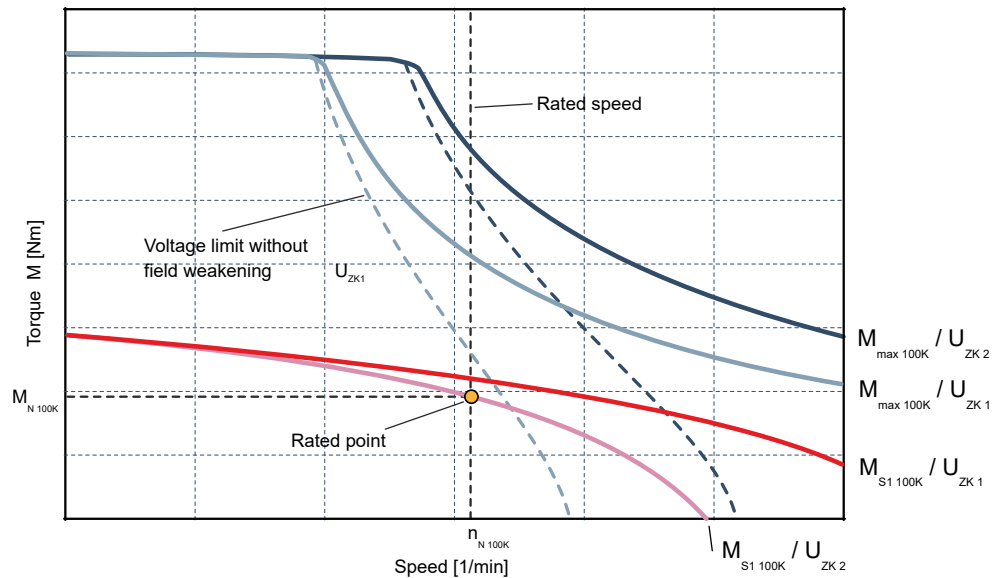

Fig. 20: Rated point

In case of motors with high speeds, the rated point of the characteristic voltage limit curve U_{ZK1} can be displayed in the direction of the point of origin.

The rated data are specified on type place of the motors as well as in the technical data sheet.

6.4 Tolerances

The values specified in the technical data are subject to a natural dispersion. Observe the tolerance specifications for the following parameters.

Table 19: Tolerance specifications of the motor data

Designation	Symbol	Tolerance value
Standstill torque - 60 K	$M_{0\ 60K}$	$\pm 5\%$
Standstill torque - 100 K	$M_{0\ 100K}$	$\pm 5\%$
Rotor inertia	J_{rot}	$\pm 10\%$
Rated torque - 100 K	$M_{N\ 100K}$	$\pm 5\%$
Rated power - 100 K	$P_{N\ 100K}$	$\pm 5\%$
Maximum torque 20 °C (cold)	$M_{max\ 20^\circ C}$	$\pm 5\%$
Maximum torque - 100 K (warm)	$M_{max\ 100K}$	$\pm 5\%$
Torque constant at 20 °C	K_m	$\pm 5\%$
Voltage constant at 20 °C	K_E	$\pm 5\%$

6.5 Temperature influence and tolerance

The torque-speed characteristic curves are specified for cold motors ($M_{\max 20^\circ\text{C}}$) as well as for motors at rated-load operating temperature ($M_{\max 100\text{K}}$). Following figure shows the influence of motor temperature and material variation caused by manufacturing tolerances.

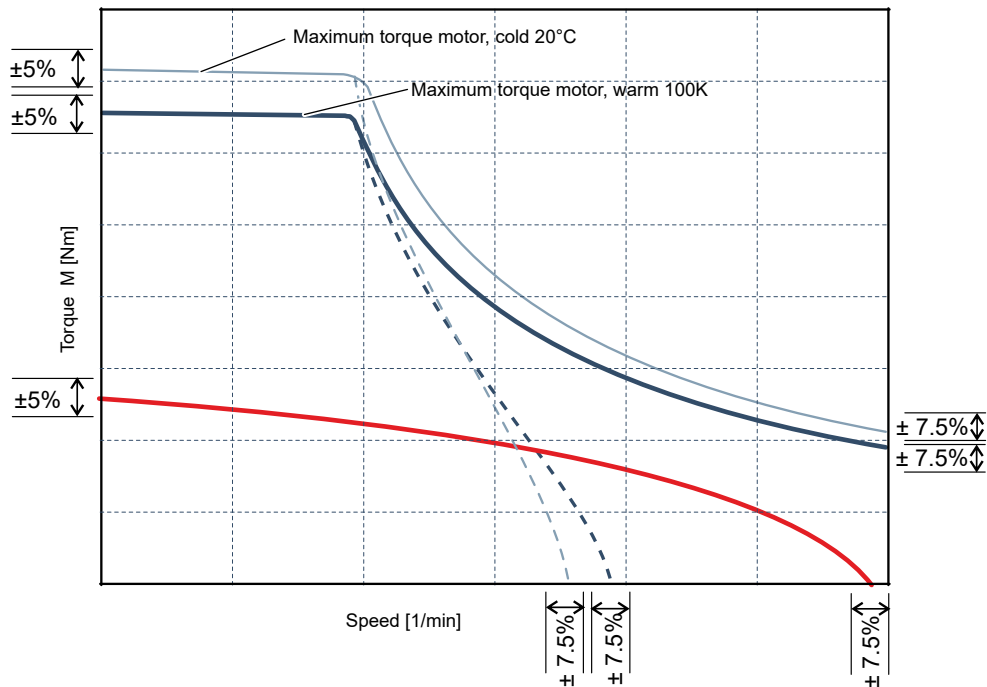

Fig. 21: Temperature influence and tolerances

The specified tolerances apply to MS2N motors with controlled and uncontrolled infeed.

6.6 Characteristic curve in gearbox mounting

Due to the self-heating of the gearboxes depending on the speed, the cooling effect in the flange mounting area is limited. A speed-dependent reduction of the specified performance data is necessary, to do not overload motors when using gearboxes.

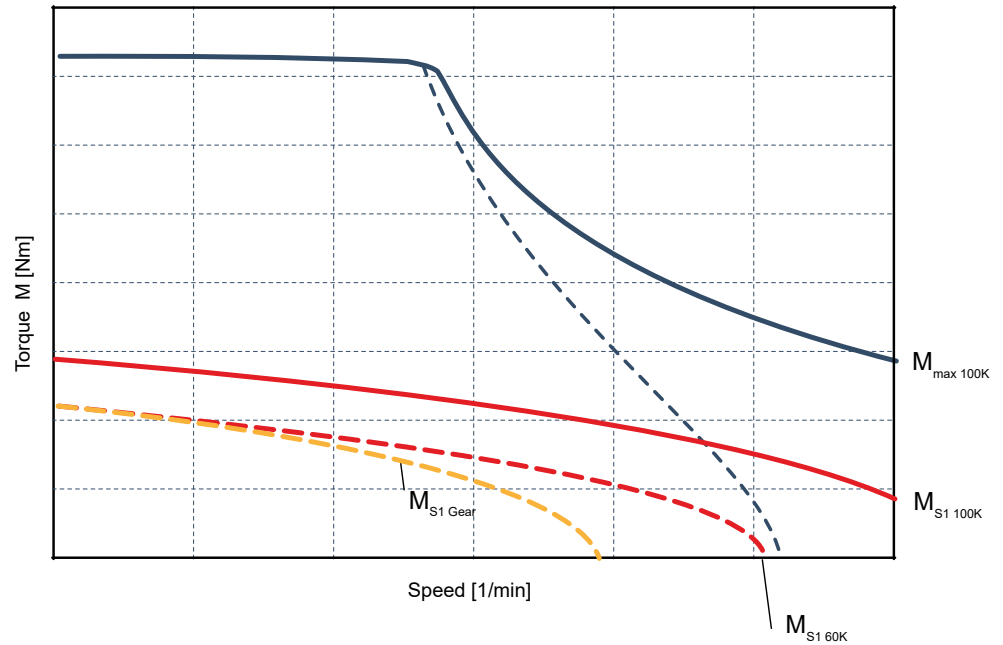

Fig. 22: S1 characteristic curve in gearbox



Remark

The standard value of reduction of the **S1 60 K characteristic curve** in gearbox mounting is **20 - 30 %**. In case of thermally critical applications (e.g. flange temperatures > 80 °C), Bosch Rexroth recommends to check the temperature load at the gearbox and the motor.

6.7 IndraSize

By using the IndraSize software, drive controllers, motors and mechanic gear-boxes can be easily sized. The engineering tool covers the entire range of Rexroth drives and motors. Calculate the characteristic curves for your application with IndraSize: ➔ www.boschrexroth.com/indraSize

- 7 Technical data
- 7.1 MS2N03 Technical data
- 7.1.1 Self-cooling

MS2N03-A0BYN

Designation	Symbol	Unit	MS2N03-A0BYN-__0-N	MS2N03-A0BYN-__1-N
Standstill torque - 60K ¹⁾	M _{0 60K}	Nm	0.45	
Standstill current - 60K	I _{0 60K}	A	1.59	
Standstill torque - 100K ¹⁾	M _{0 100K}	Nm	0.53	
Standstill current - 100K	I _{0 100K}	A	1.85	
Moment of inertia of rotor ¹⁾	J _{rot}	kg*m ²	0.00002	0.000023
Rated speed - 100K	n _{N 100K}	1/min	9,000	
Rated torque - 100K ¹⁾	M _{N 100K}	Nm	0.26	
Rated current - 100K	I _{N 100K}	A	1.06	
Rated power - 100K ¹⁾	P _{N 100K}	kW	0.25	
Maximum torque 20 °C (cold) ¹⁾	M _{max 20°C}	Nm	1.85	
Maximum torque 100K (warm) ¹⁾	M _{max 100K}	Nm	1.71	
Maximum current	I _{max(eff)}	A	7.25	
Maximum speed (electrical)	n _{max el}	1/min	9,000	
Maximum speed (mechanical)	n _{max mech}	1/min	9,000	
Number of pole pairs	p		5	
Torque constant at 20 °C ¹⁾	K _m	Nm/A	0.31	
Voltage constant at 20 °C ¹⁾	K _E	V/1000 min ⁻¹	19.0	
Winding resistance at 20 °C	R ₁₂	Ohm	8.96	
Winding inductance	L _{12,min}	mH	12.37	
Leakage capacitance of the component	C _{ab}	nF	0.39	
Thermal time constant of winding	T _{th,W}	s	11.5	
Thermal time constant of motor	T _{th,M}	min	11.0	
Mass	m _{mot}	kg	1.10	1.35
Holding brake				
Holding torque	M ₄	Nm	0	1.80
Rated voltage	U _N	V	0	24
Rated current	I _N	A	0	0.46
Maximum connection time	t ₁	ms	0	8
Maximum disconnection time	t ₂	ms	0	35
1) For tolerance details refer to chapter 6.4 Tolerances			Latest amendment: 2020-09-23	

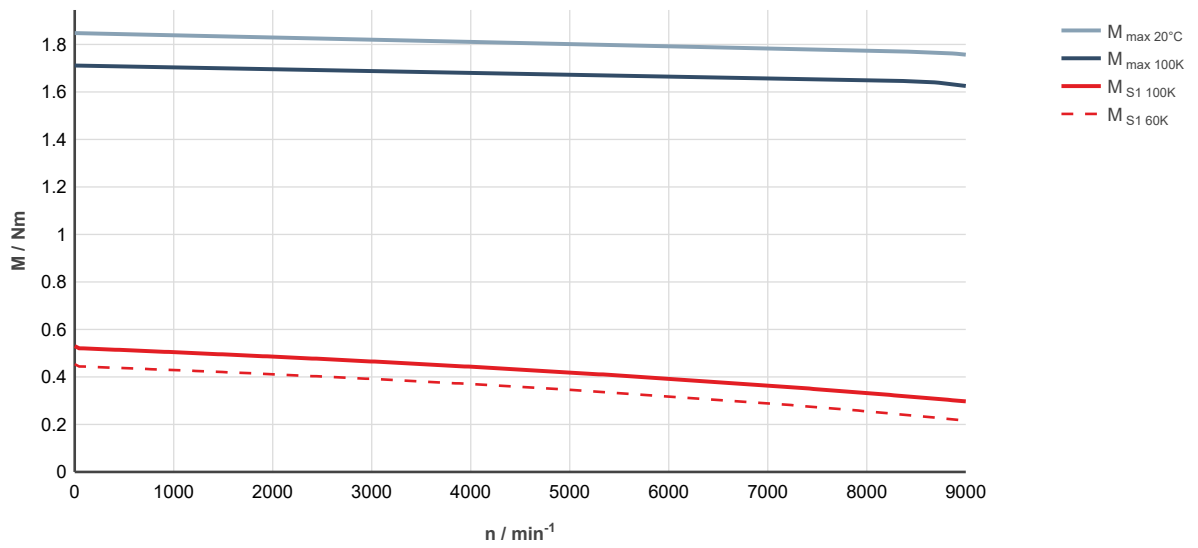

Fig. 23: MS2N03-A0BYN-___0-___-__, ctrlX DRIVE, uncontrolled supply 3 × AC 400 V

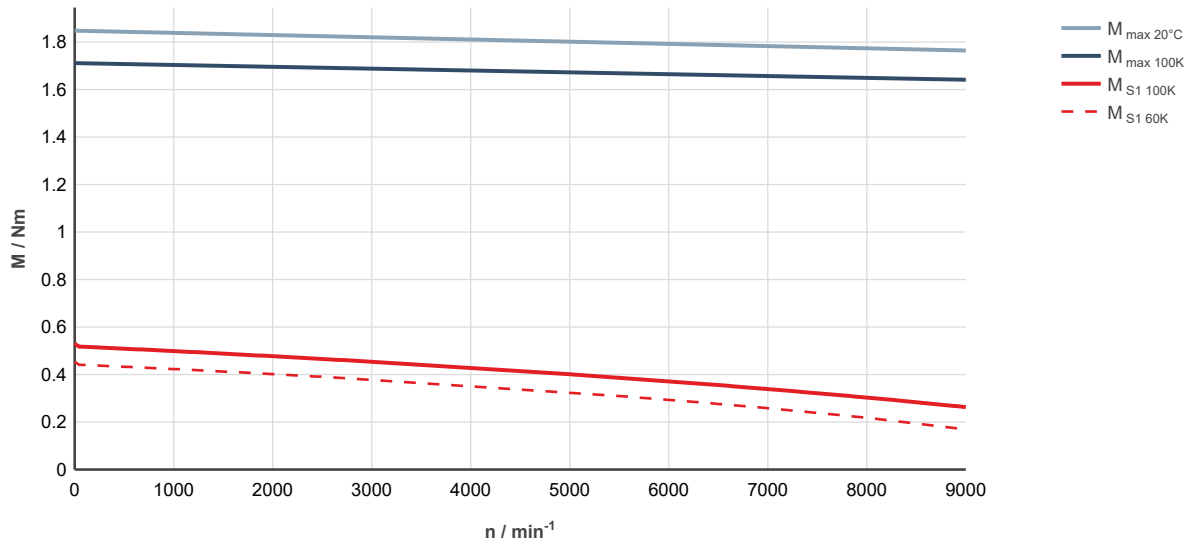

Fig. 24: MS2N03-A0BYN-___0-___-__, ctrlX DRIVE, controlled supply 3 x AC 400 ... 480 V

MS2N03-B0BYN

Designation	Symbol	Unit	MS2N03-B0BYN-__0-_N	MS2N03-B0BYN-__1-_N
Standstill torque - 60K ¹⁾	M _{0 60K}	Nm	0.73	
Standstill current - 60K	I _{0 60K}	A	1.31	
Standstill torque - 100K ¹⁾	M _{0 100K}	Nm	0.9	
Standstill current - 100K	I _{0 100K}	A	1.61	
Moment of inertia of rotor ¹⁾	J _{rot}	kg*m ²	0.000023	0.000030
Rated speed - 100K	n _{N 100K}	1/min	6470	
Rated torque - 100K ¹⁾	M _{N 100K}	Nm	0.54	
Rated current - 100K	I _{N 100K}	A	1.08	
Rated power - 100K ¹⁾	P _{N 100K}	kW	0.37	
Maximum torque 20 °C (cold) ¹⁾	M _{max 20°C}	Nm	3.75	
Maximum torque 100K (warm) ¹⁾	M _{max 100K}	Nm	3.46	
Maximum current	I _{max(rms)}	A	7.25	
Maximum speed (electrical)	n _{max el}	1/min	9000	
Maximum speed (mechanical)	n _{max mech}	1/min	9000	
Number of pole pairs	p		5	
Torque constant at 20 °C ¹⁾	K _m	Nm/A	0.61	
Voltage constant at 20 °C ¹⁾	K _E	V/1000 min ⁻¹	36.9	
Winding resistance at 20 °C	R ₁₂	Ohm	14.3	
Winding inductance	L _{12,min}	mH	20.22	
Leakage capacitance of the component	C _{ab}	nF	0.83	
Thermal time constant of winding	T _{th,W}	s	12.1	
Thermal time constant of motor	T _{th,M}	min	11.3	
Mass	m _{mot}	kg	1.4	1.8
Holding brake				
Holding torque	M ₄	Nm	0	1.80
Rated voltage	U _N	V	0	24
Rated current	I _N	A	0	0.46
Maximum connection time	t ₁	ms	0	8
Maximum disconnection time	t ₂	ms	0	35
1) For tolerance details refer to chapter 6.4 Tolerances			Latest amendment: 2016-12-14	

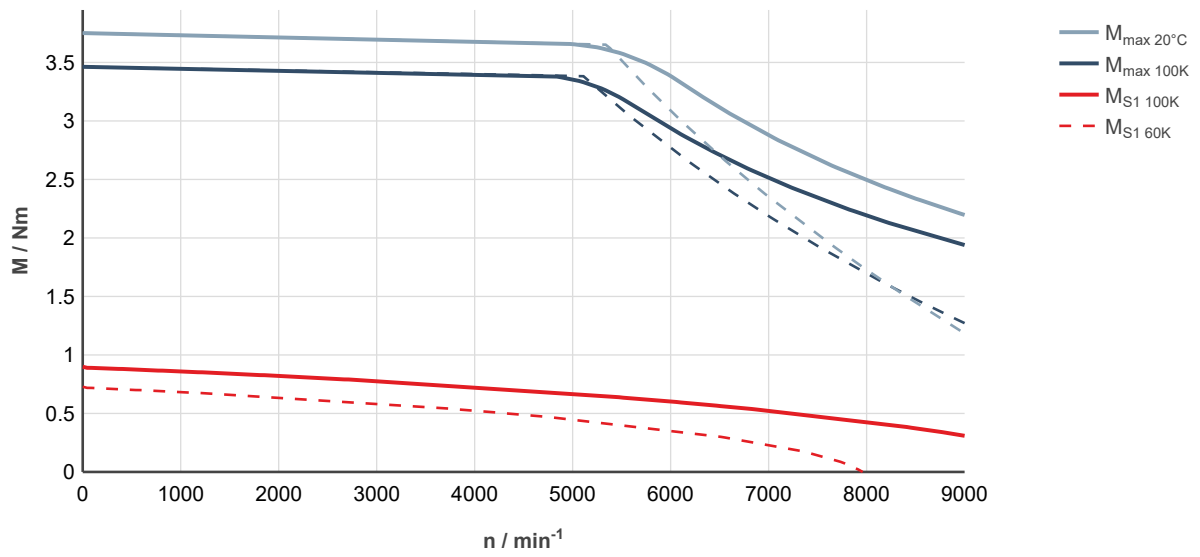

Fig. 25: MS2N03-B0BYN-___0-___-_, ctrlX DRIVE, uncontrolled supply 3 × AC 400 V

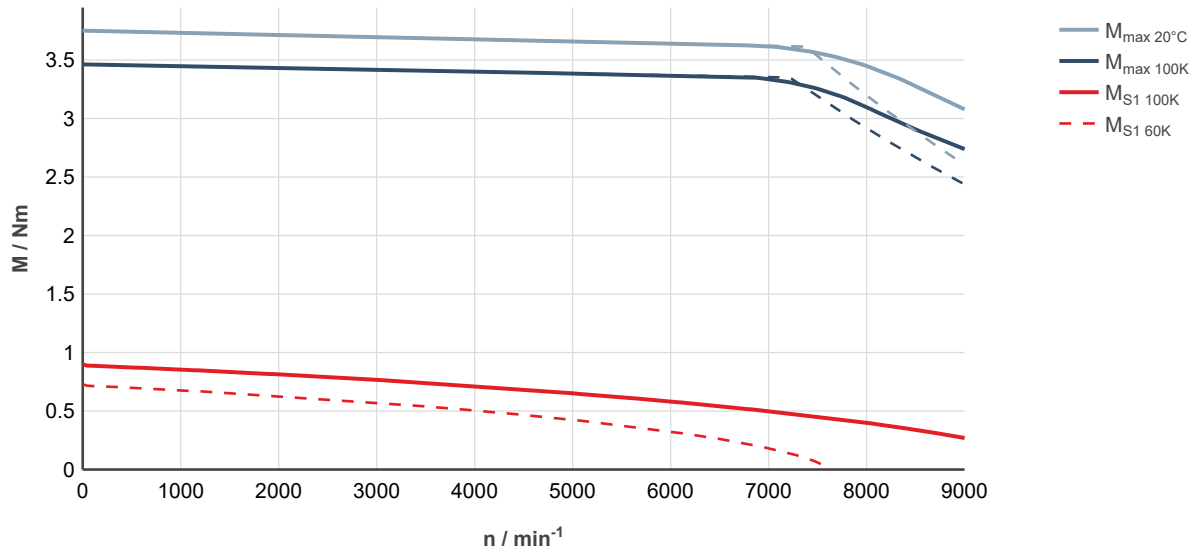

Fig. 26: MS2N03-B0BYN-___0-___-_, ctrlX DRIVE, controlled supply 3 × AC 400 ... 480 V

MS2N03-D0BYN

Designation	Symbol	Unit	MS2N03-D0BYN-__0-_N	MS2N03-D0BYN-__1-_N
Standstill torque - 60K ¹⁾	M _{0 60K}	Nm	1.15	
Standstill current - 60K	I _{0 60K}	A	2.07	
Standstill torque - 100K ¹⁾	M _{0 100K}	Nm	1.45	
Standstill current - 100K	I _{0 100K}	A	2.6	
Moment of inertia of rotor ¹⁾	J _{rot}	kg*m ²	0.000037	0.000044
Rated speed - 100K	n _{N 100K}	1/min	5700	
Rated torque - 100K ¹⁾	M _{N 100K}	Nm	0.68	
Rated current - 100K	I _{N 100K}	A	1.39	
Rated power - 100K ¹⁾	P _{N 100K}	kW	0.4	
Maximum torque 20 °C (cold) ¹⁾	M _{max 20°C}	Nm	7.4	
Maximum torque 100K (warm) ¹⁾	M _{max 100K}	Nm	6.8	
Maximum current	I _{max(rms)}	A	14.5	
Maximum speed (electrical)	n _{max el}	1/min	9000	
Maximum speed (mechanical)	n _{max mech}	1/min	9000	
Number of pole pairs	p		5	
Torque constant at 20 °C ¹⁾	K _m	Nm/A	0.6	
Voltage constant at 20 °C ¹⁾	K _E	V/1000 min ⁻¹	36.2	
Winding resistance at 20 °C	R ₁₂	Ohm	6.29	
Winding inductance	L _{12,min}	mH	9.56	
Leakage capacitance of the component	C _{ab}	nF	1.6	
Thermal time constant of winding	T _{th,W}	s	14.5	
Thermal time constant of motor	T _{th,M}	min	12.1	
Mass	m _{mot}	kg	2.0	2.4
Holding brake				
Holding torque	M ₄	Nm	0	1.80
Rated voltage	U _N	V	0	24
Rated current	I _N	A	0	0.46
Maximum connection time	t ₁	ms	0	8
Maximum disconnection time	t ₂	ms	0	35

1) For tolerance details refer to [chapter 6.4 Tolerances](#)

Latest amendment: 2016-12-14

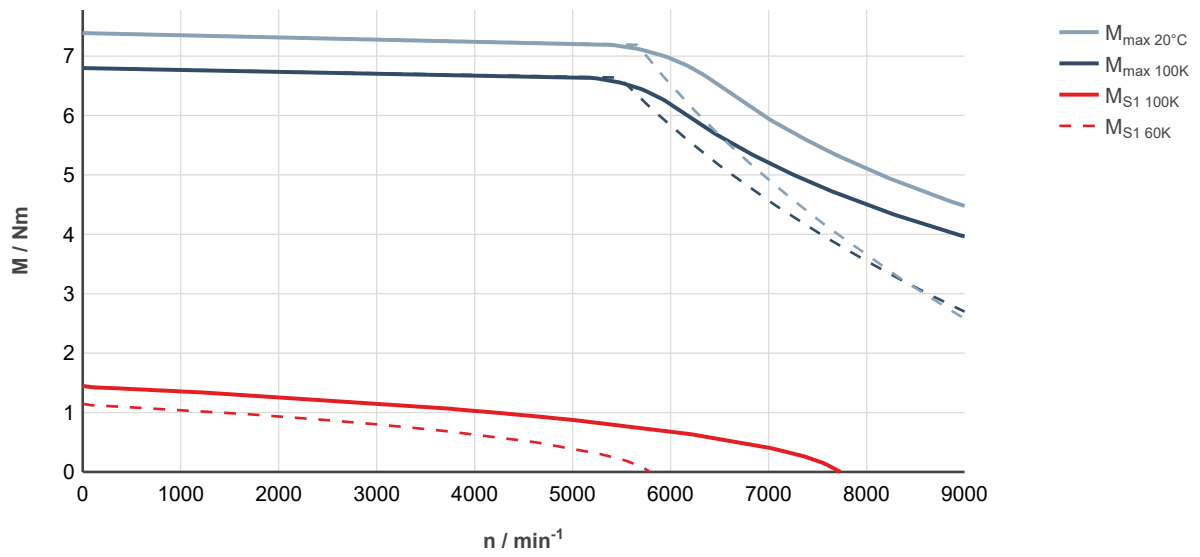

Fig. 27: MS2N03-D0BYN-___0-___-__, ctrlX DRIVE, uncontrolled supply 3 × AC 400 V

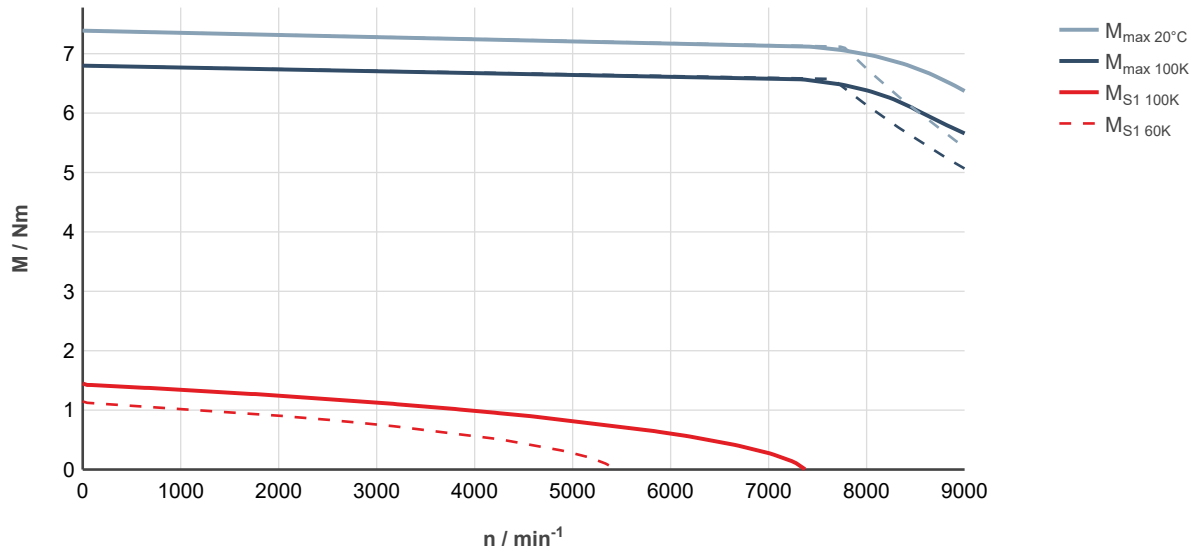
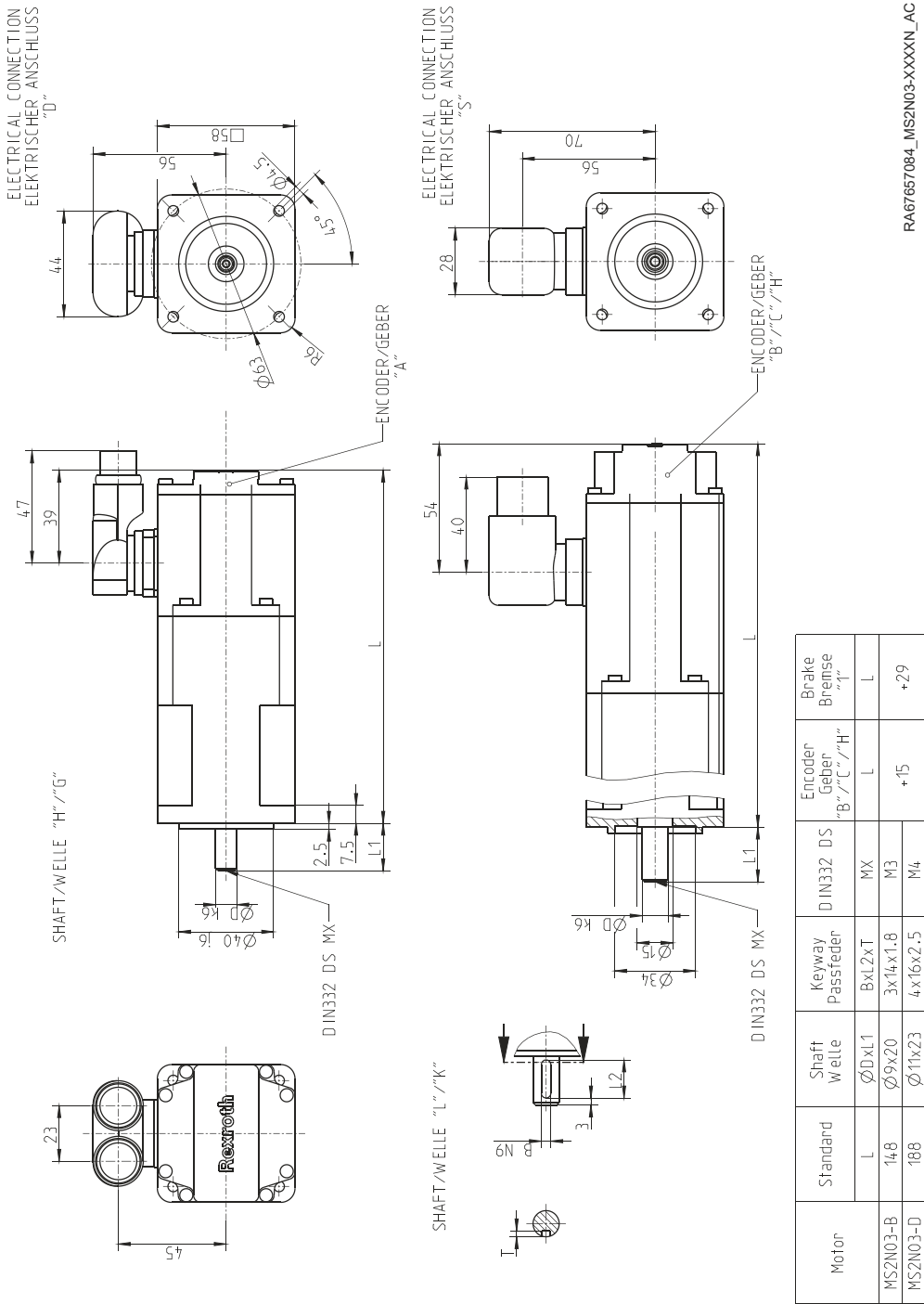

Fig. 28: MS2N03-D0BYN-___0-___-__, ctrlX DRIVE, controlled supply 3 × AC 400 ... 480 V

7.1.2 Specification MS2N03 Self-cooling with M17 double plug / M23 single cable connector



RA67657084_MS2N03-XXXXN_AC

Motor	Standard	Shaft welle	Keyway Passfeder	D IN332 DS	Encoder Geber "B"/"C"/"H"	Brake Bremse "1"
MS2N03-B	L	ØDxL1	BxL2xT	MX	L	L
MS2N03-D	148	Ø9x20	3x14x1.8	M3	+15	+29
	188	Ø11x23	4x16x2.5	M4		

Fig. 29: MS2N03-xxxxD/S

7.1.4 MS2N03 Axial force

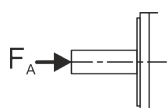

Axial forces F_A only allowed after a detailed dimensioning by your distribution partner at Bosch Rexroth. For evaluation purposes, please specify the following information:

- Axial and radial force with force application point
- Installation position (horizontal, vertical with the shaft end pointing to the top or bottom)
- Mean speed

7.1.5 MS2N03 Radial force

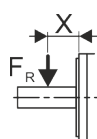

The permissible radial force F_R is specified in distance x from the shaft shoulder, depending on the mean speed in the following diagram.

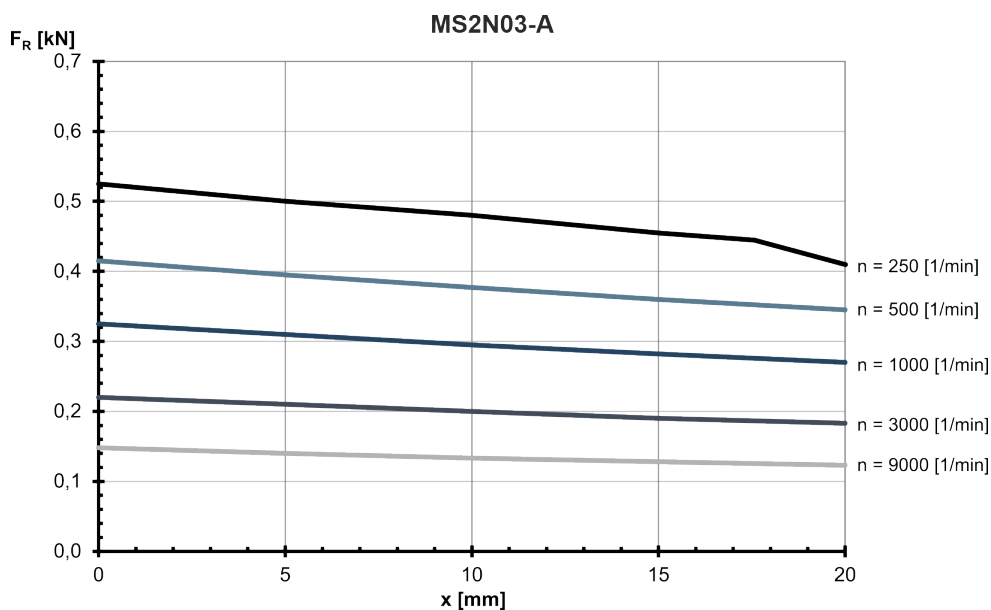

Fig. 31: MS2N03-A: Radial force in distance x from the shaft shoulder at a nominal bearing service life of $L_{h10} = 30000$ h

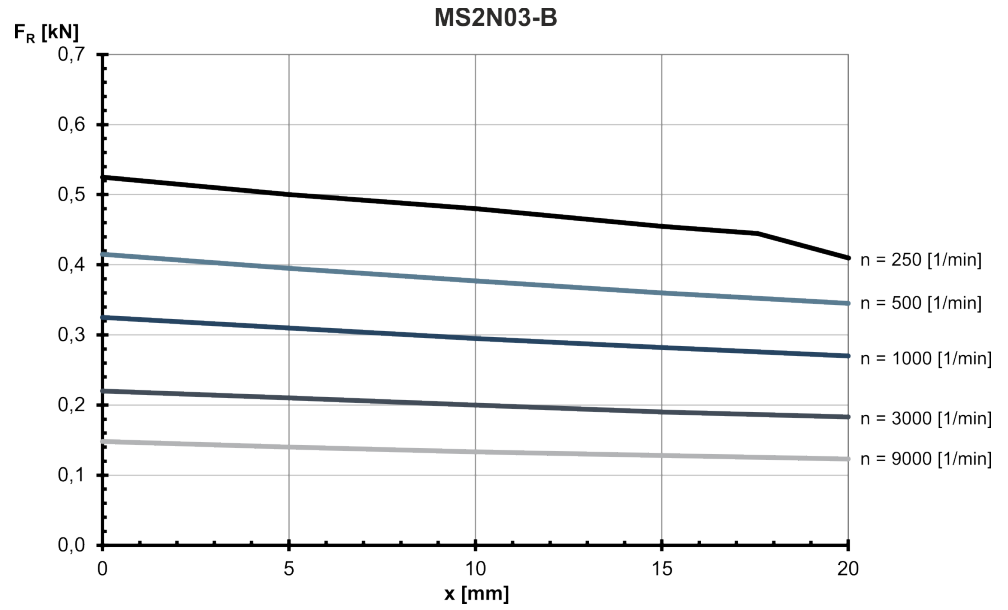

Fig. 32: MS2N03-B: Radial force in distance x from the shaft shoulder at a nominal bearing service life of $L_{h10} = 30000$ h

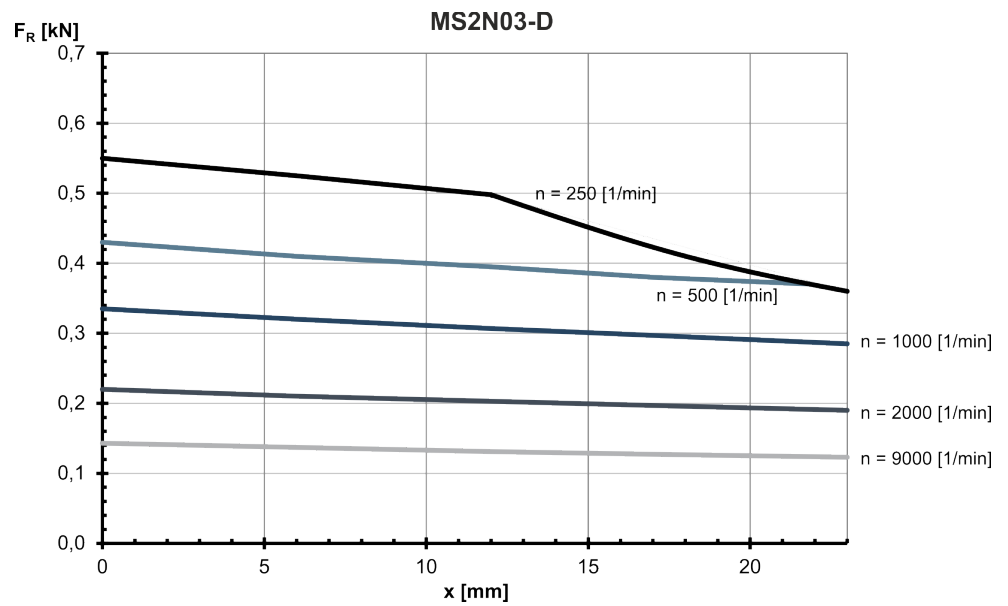

Fig. 33: MS2N03-D: Radial force in distance x from the shaft shoulder at a nominal bearing service life of $L_{h10} = 30000$ h

7.2 MS2N04 Technical data

7.2.1 Self-cooling

MS2N04-B0BNN

Designation	Symbol	Unit	MS2N04-B0BNN-__0-_N	MS2N04-B0BNN-__1-_N
Standstill torque - 60K ¹⁾	M _{0 60K}	Nm	1.75	
Standstill current - 60K	I _{0 60K}	A	1.11	
Standstill torque - 100K ¹⁾	M _{0 100K}	Nm	2.15	
Standstill current - 100K	I _{0 100K}	A	1.36	
Moment of inertia of rotor ¹⁾	J _{rot}	kg*m ²	0.00007	0.00011
Rated speed - 100K	n _{N 100K}	1/min	3000	
Rated torque - 100K ¹⁾	M _{N 100K}	Nm	1.67	
Rated current - 100K	I _{N 100K}	A	1.11	
Rated power - 100K ¹⁾	P _{N 100K}	kW	0.53	
Maximum torque 20 °C (cold) ¹⁾	M _{max 20°C}	Nm	6.4	
Maximum torque 100K (warm) ¹⁾	M _{max 100K}	Nm	5.9	
Maximum current	I _{max(rms)}	A	4.9	
Maximum speed (electrical)	n _{max el}	1/min	6000	
Maximum speed (mechanical)	n _{max mech}	1/min	6000	
Number of pole pairs	p		5	
Torque constant at 20 °C ¹⁾	K _m	Nm/A	1.73	
Voltage constant at 20 °C ¹⁾	K _E	V/1000 min ⁻¹	104.9	
Winding resistance at 20 °C	R ₁₂	Ohm	26.2	
Winding inductance	L _{12,min}	mH	110.09	
Leakage capacitance of the component	C _{ab}	nF	1.1	
Thermal time constant of winding	T _{th,W}	s	18.9	
Thermal time constant of motor	T _{th,M}	min	12.7	
Mass	m _{mot}	kg	2.7	3.4
Holding brake				
Holding torque	M ₄	Nm	0	5.00
Rated voltage	U _N	V	0	24
Rated current	I _N	A	0	0.63
Maximum connection time	t ₁	ms	0	30
Maximum disconnection time	t ₂	ms	0	45
1) For tolerance details refer to chapter 6.4 Tolerances			Latest amendment: 2017-05-05	

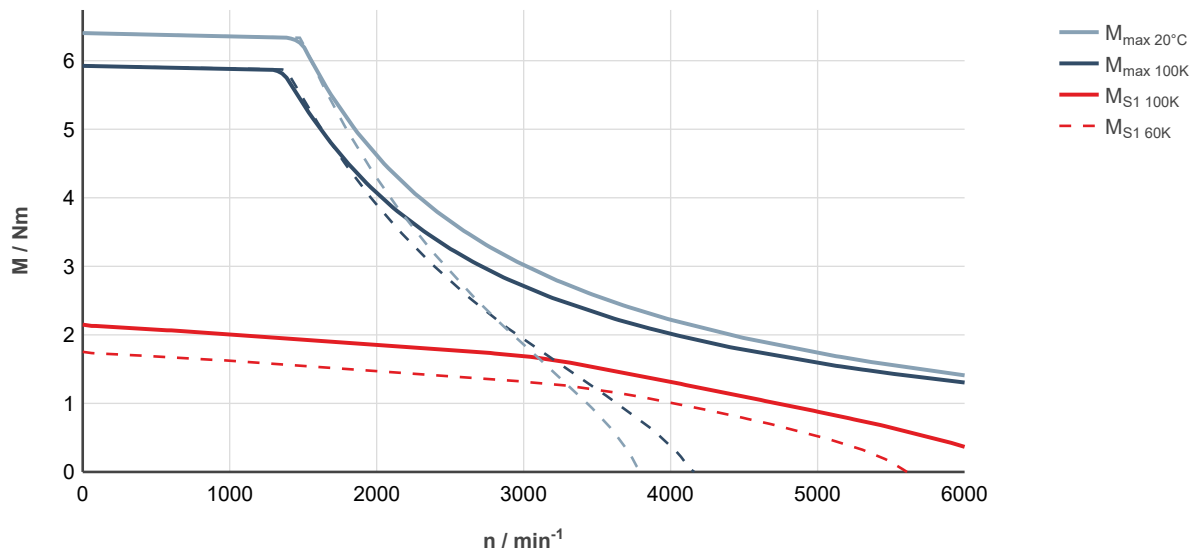

Fig. 34: MS2N04-B0BNN-___0-___-___, ctrlX DRIVE, uncontrolled supply 3 × AC 400 V

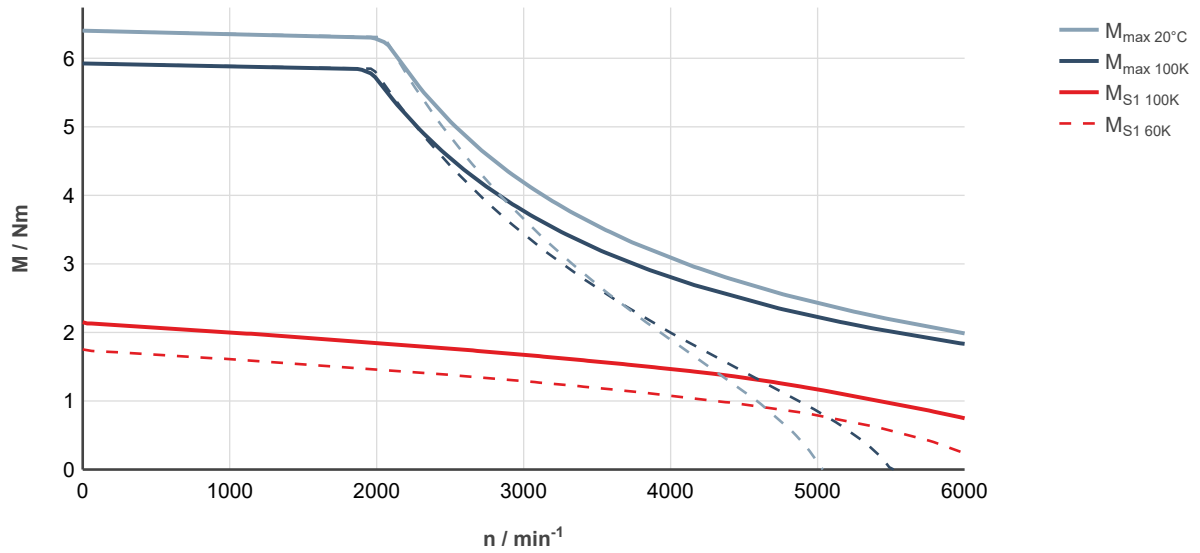

Fig. 35: MS2N04-B0BNN-___0-___-___, ctrlX DRIVE, controlled supply 3 × AC 400 ... 480 V

MS2N04-B0BTN

Designation	Symbol	Unit	MS2N04-B0BTN-__0-_N	MS2N04-B0BTN-__1-_N
Standstill torque - 60K ¹⁾	M _{0 60K}	Nm	1.75	
Standstill current - 60K	I _{0 60K}	A	2.2	
Standstill torque - 100K ¹⁾	M _{0 100K}	Nm	2.15	
Standstill current - 100K	I _{0 100K}	A	2.7	
Moment of inertia of rotor ¹⁾	J _{rot}	kg*m ²	0.00007	0.00011
Rated speed - 100K	n _{N 100K}	1/min	4980	
Rated torque - 100K ¹⁾	M _{N 100K}	Nm	1.09	
Rated current - 100K	I _{N 100K}	A	1.51	
Rated power - 100K ¹⁾	P _{N 100K}	kW	0.57	
Maximum torque 20 °C (cold) ¹⁾	M _{max 20°C}	Nm	6.4	
Maximum torque 100K (warm) ¹⁾	M _{max 100K}	Nm	5.9	
Maximum current	I _{max(rms)}	A	9.8	
Maximum speed (electrical)	n _{max el}	1/min	6000	
Maximum speed (mechanical)	n _{max mech}	1/min	6000	
Number of pole pairs	p		5	
Torque constant at 20 °C ¹⁾	K _m	Nm/A	0.87	
Voltage constant at 20 °C ¹⁾	K _E	V/1000 min ⁻¹	52.7	
Winding resistance at 20 °C	R ₁₂	Ohm	6.55	
Winding inductance	L _{12,min}	mH	27.52	
Leakage capacitance of the component	C _{ab}	nF	1.1	
Thermal time constant of winding	T _{th,W}	s	18.9	
Thermal time constant of motor	T _{th,M}	min	12.7	
Mass	m _{mot}	kg	2.7	3.4
Holding brake				
Holding torque	M ₄	Nm	0	5.00
Rated voltage	U _N	V	0	24
Rated current	I _N	A	0	0.63
Maximum connection time	t ₁	ms	0	30
Maximum disconnection time	t ₂	ms	0	45
1) For tolerance details refer to chapter 6.4 Tolerances			Latest amendment: 2017-05-05	

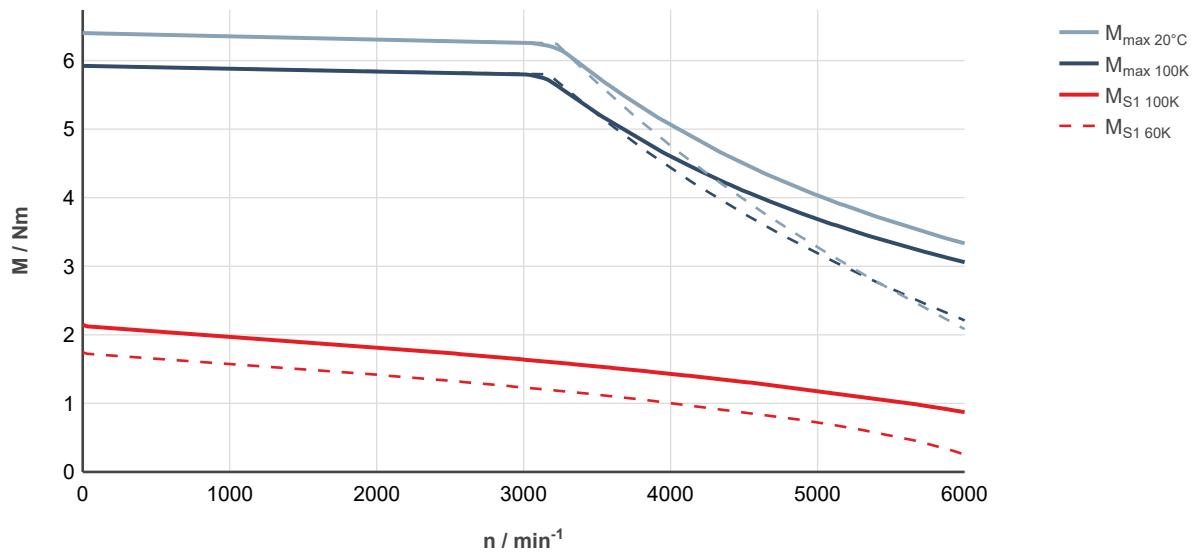

Fig. 36: MS2N04-B0BTN-___0-___-__, ctrlX DRIVE, uncontrolled supply 3 × AC 400 V

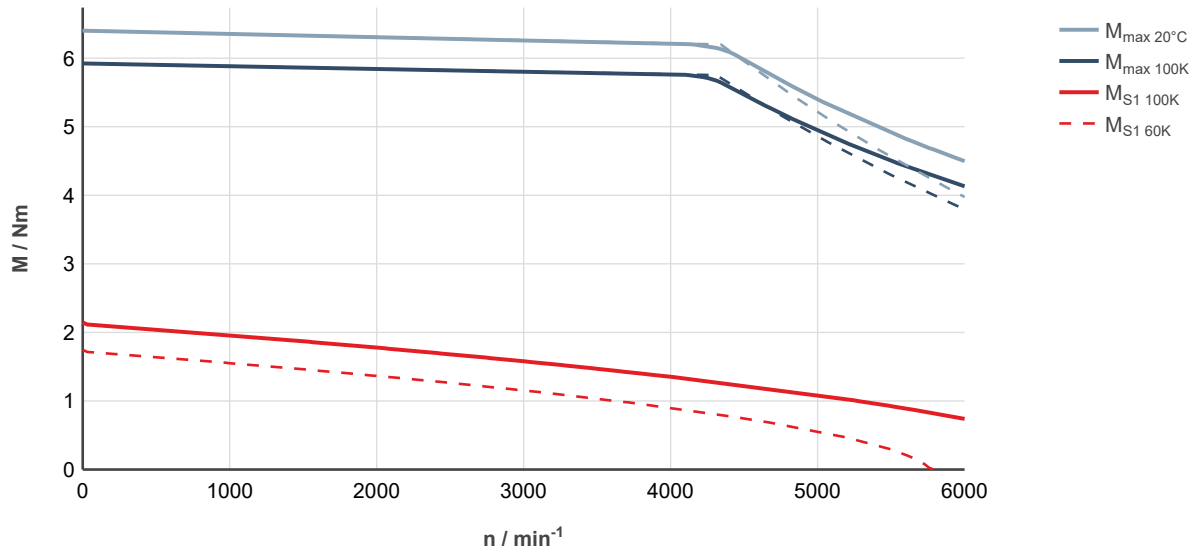

Fig. 37: MS2N04-B0BTN-___0-___-__, ctrlX DRIVE, controlled supply 3 × AC 400 ... 480 V

MS2N04-C0BNN

Designation	Symbol	Unit	MS2N04-C0BNN-__0-_N	MS2N04-C0BNN-__1-_N
Standstill torque - 60K ¹⁾	M _{0 60K}	Nm	2.8	
Standstill current - 60K	I _{0 60K}	A	1.78	
Standstill torque - 100K ¹⁾	M _{0 100K}	Nm	3.5	
Standstill current - 100K	I _{0 100K}	A	2.24	
Moment of inertia of rotor ¹⁾	J _{rot}	kg*m ²	0.00011	0.00016
Rated speed - 100K	n _{N 100K}	1/min	3230	
Rated torque - 100K ¹⁾	M _{N 100K}	Nm	2.39	
Rated current - 100K	I _{N 100K}	A	1.61	
Rated power - 100K ¹⁾	P _{N 100K}	kW	0.81	
Maximum torque 20 °C (cold) ¹⁾	M _{max 20°C}	Nm	13.05	
Maximum torque 100K (warm) ¹⁾	M _{max 100K}	Nm	12.00	
Maximum current	I _{max(rms)}	A	9.7	
Maximum speed (electrical)	n _{max el}	1/min	6000	
Maximum speed (mechanical)	n _{max mech}	1/min	6000	
Number of pole pairs	p		5	
Torque constant at 20 °C ¹⁾	K _m	Nm/A	1.74	
Voltage constant at 20 °C ¹⁾	K _E	V/1000 min ⁻¹	105.7	
Winding resistance at 20 °C	R ₁₂	Ohm	10.9	
Winding inductance	L _{12,min}	mH	52.4	
Leakage capacitance of the component	C _{ab}	nF	2.2	
Thermal time constant of winding	T _{th,W}	s	35.3	
Thermal time constant of motor	T _{th,M}	min	16.0	
Mass	m _{mot}	kg	3.7	4.4
Holding brake				
Holding torque	M ₄	Nm	0	5.00
Rated voltage	U _N	V	0	24
Rated current	I _N	A	0	0.63
Maximum connection time	t ₁	ms	0	30
Maximum disconnection time	t ₂	ms	0	45
1) For tolerance details refer to chapter 6.4 Tolerances			Latest amendment: 2017-05-05	

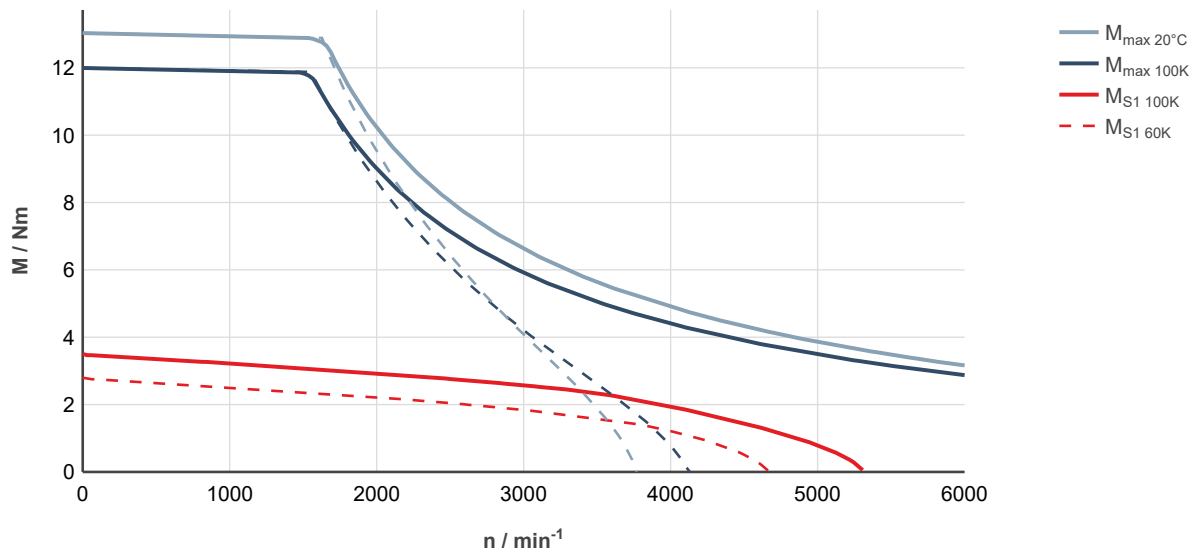

Fig. 38: MS2N04-C0BNN-___0-___-__, ctrlX DRIVE, uncontrolled supply 3 × AC 400 V

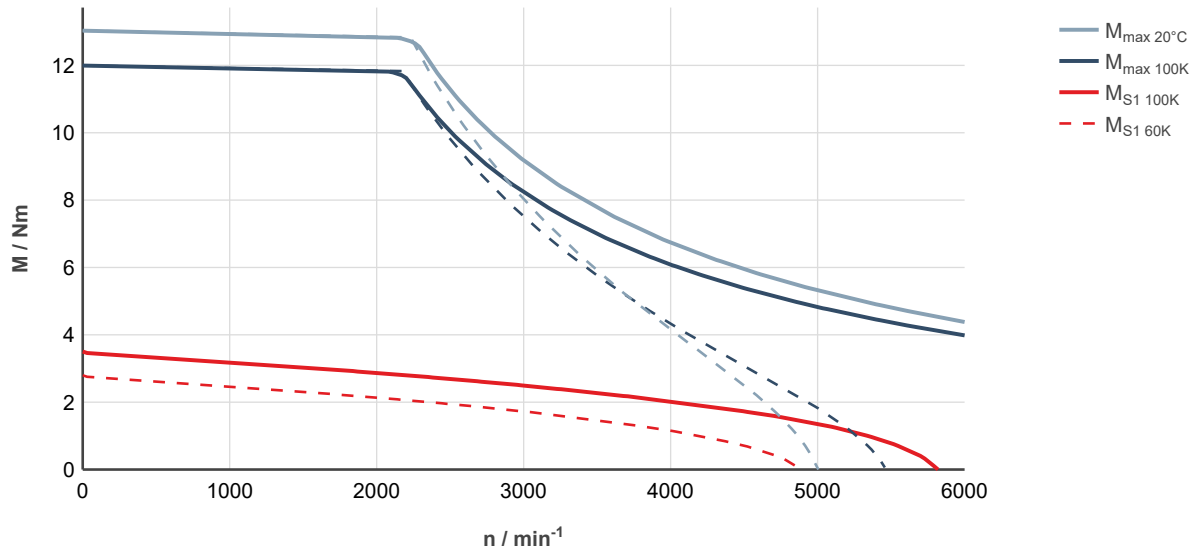

Fig. 39: MS2N04-C0BNN-___0-___-__, ctrlX DRIVE, controlled supply 3 × AC 400 ... 480 V

MS2N04-C0BTN

Designation	Symbol	Unit	MS2N04-C0BTN-__0-_N	MS2N04-C0BTN-__1-_N
Standstill torque - 60K ¹⁾	M _{0 60K}	Nm	2.80	
Standstill current - 60K	I _{0 60K}	A	3.11	
Standstill torque - 100K ¹⁾	M _{0 100K}	Nm	3.50	
Standstill current - 100K	I _{0 100K}	A	3.9	
Moment of inertia of rotor ¹⁾	J _{rot}	kg*m ²	0.00011	0.00016
Rated speed - 100K	n _{N 100K}	1/min	3900	
Rated torque - 100K ¹⁾	M _{N 100K}	Nm	1.66	
Rated current - 100K	I _{N 100K}	A	2.01	
Rated power - 100K ¹⁾	P _{N 100K}	kW	0.68	
Maximum torque 20 °C (cold) ¹⁾	M _{max 20°C}	Nm	13.05	
Maximum torque 100K (warm) ¹⁾	M _{max 100K}	Nm	12.00	
Maximum current	I _{max(rms)}	A	17.3	
Maximum speed (electrical)	n _{max el}	1/min	6000	
Maximum speed (mechanical)	n _{max mech}	1/min	6000	
Number of pole pairs	p		5	
Torque constant at 20 °C ¹⁾	K _m	Nm/A	0.98	
Voltage constant at 20 °C ¹⁾	K _E	V/1000 min ⁻¹	59.8	
Winding resistance at 20 °C	R ₁₂	Ohm	3.5	
Winding inductance	L _{12_min}	mH	17.86	
Leakage capacitance of the component	C _{ab}	nF	1.8	
Thermal time constant of winding	T _{th_W}	s	35.3	
Thermal time constant of motor	T _{th_M}	min	16.0	
Mass	m _{mot}	kg	3.7	4.4
Holding brake				
Holding torque	M ₄	Nm	0	5.00
Rated voltage	U _N	V	0	24
Rated current	I _N	A	0	0.63
Maximum connection time	t ₁	ms	0	30
Maximum disconnection time	t ₂	ms	0	45
1) For tolerance details refer to chapter 6.4 Tolerances			Latest amendment: 2017-05-05	

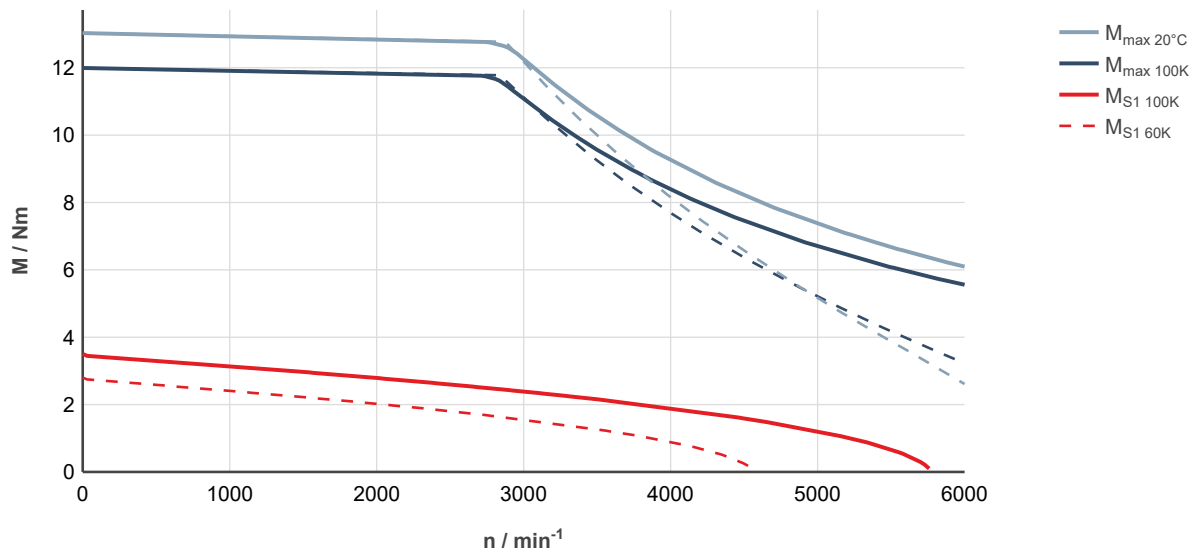

Fig. 40: MS2N04-C0BTN-___0-___-__, ctrlX DRIVE, uncontrolled supply 3 × AC 400 V

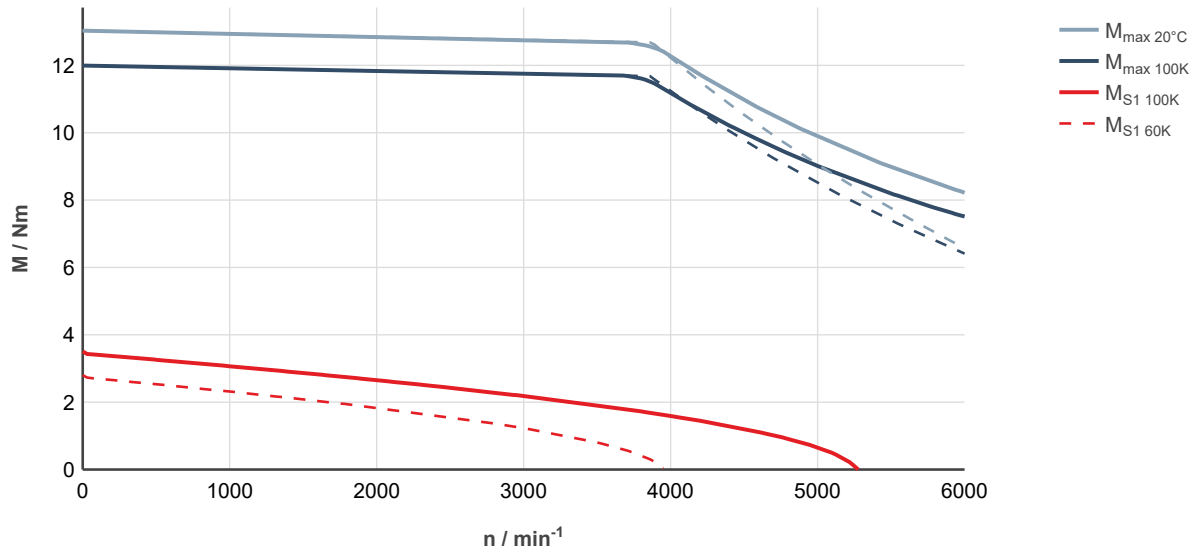

Fig. 41: MS2N04-C0BTN-___0-___-__, ctrlX DRIVE, controlled supply 3 × AC 400 ... 480 V

MS2N04-D0BHN

Designation	Symbol	Unit	MS2N04-D0BHN-__0-_N	MS2N04-D0BHN-__1-_N
Standstill torque - 60K ¹⁾	M _{0 60K}	Nm	3.85	
Standstill current - 60K	I _{0 60K}	A	1.61	
Standstill torque - 100K ¹⁾	M _{0 100K}	Nm	4.65	
Standstill current - 100K	I _{0 100K}	A	1.96	
Moment of inertia of rotor ¹⁾	J _{rot}	kg*m ²	0.00016	0.00020
Rated speed - 100K	n _{N 100K}	1/min	2040	
Rated torque - 100K ¹⁾	M _{N 100K}	Nm	3.75	
Rated current - 100K	I _{N 100K}	A	1.63	
Rated power - 100K ¹⁾	P _{N 100K}	kW	0.8	
Maximum torque 20 °C (cold) ¹⁾	M _{max 20°C}	Nm	19.7	
Maximum torque 100K (warm) ¹⁾	M _{max 100K}	Nm	18.1	
Maximum current	I _{max(rms)}	A	9.7	
Maximum speed (electrical)	n _{max el}	1/min	4000	
Maximum speed (mechanical)	n _{max mech}	1/min	6000	
Number of pole pairs	p		5	
Torque constant at 20 °C ¹⁾	K _m	Nm/A	2.62	
Voltage constant at 20 °C ¹⁾	K _E	V/1000 min ⁻¹	159.1	
Winding resistance at 20 °C	R ₁₂	Ohm	15.8	
Winding inductance	L _{12,min}	mH	77.27	
Leakage capacitance of the component	C _{ab}	nF	2.95	
Thermal time constant of winding	T _{th,W}	s	44.0	
Thermal time constant of motor	T _{th,M}	min	18.5	
Mass	m _{mot}	kg	4.7	5.4
Holding brake				
Holding torque	M ₄	Nm	0	5.00
Rated voltage	U _N	V	0	24
Rated current	I _N	A	0	0.63
Maximum connection time	t ₁	ms	0	30
Maximum disconnection time	t ₂	ms	0	45

1) For tolerance details refer to [chapter 6.4 Tolerances](#)

Latest amendment: 2017-05-05

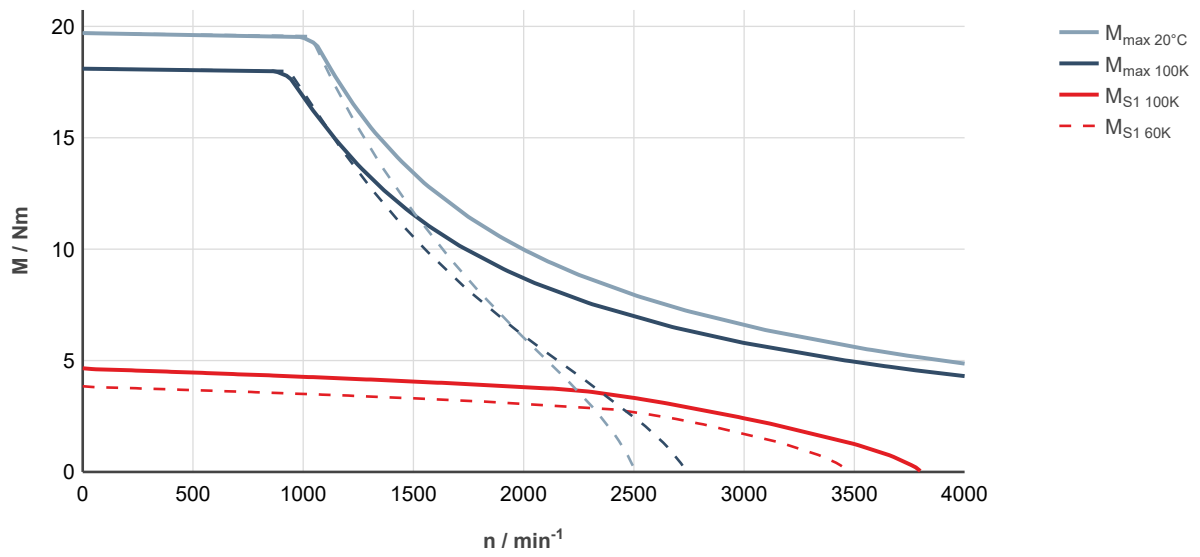

Fig. 42: MS2N04-D0BHN-___0-___-_, ctrlX DRIVE, uncontrolled supply 3 × AC 400 V

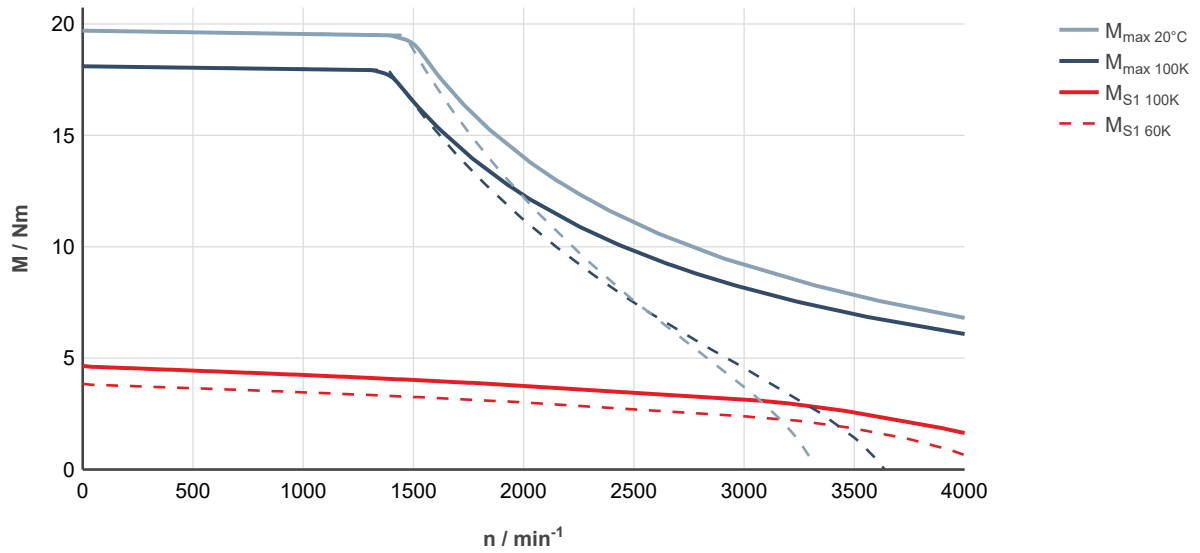

Fig. 43: MS2N04-D0BHN-___0-___-_, ctrlX DRIVE, controlled supply 3 × AC 400 ... 480 V

MS2N04-D0BQN

Designation	Symbol	Unit	MS2N04-D0BQN-__0-_N	MS2N04-D0BQN-__1-_N
Standstill torque - 60K ¹⁾	M _{0 60K}	Nm	3.85	
Standstill current - 60K	I _{0 60K}	A	2.86	
Standstill torque - 100K ¹⁾	M _{0 100K}	Nm	4.65	
Standstill current - 100K	I _{0 100K}	A	3.48	
Moment of inertia of rotor ¹⁾	J _{rot}	kg*m ²	0.00016	0.00020
Rated speed - 100K	n _{N 100K}	1/min	3320	
Rated torque - 100K ¹⁾	M _{N 100K}	Nm	2.65	
Rated current - 100K	I _{N 100K}	A	2.12	
Rated power - 100K ¹⁾	P _{N 100K}	kW	0.92	
Maximum torque 20 °C (cold) ¹⁾	M _{max 20°C}	Nm	19.7	
Maximum torque 100K (warm) ¹⁾	M _{max 100K}	Nm	18.1	
Maximum current	I _{max(rms)}	A	17.3	
Maximum speed (electrical)	n _{max el}	1/min	6000	
Maximum speed (mechanical)	n _{max mech}	1/min	6000	
Number of pole pairs	p		5	
Torque constant at 20 °C ¹⁾	K _m	Nm/A	1.48	
Voltage constant at 20 °C ¹⁾	K _E	V/1000 min ⁻¹	89.9	
Winding resistance at 20 °C	R ₁₂	Ohm	4.87	
Winding inductance	L _{12,min}	mH	24.5	
Leakage capacitance of the component	C _{ab}	nF	3.24	
Thermal time constant of winding	T _{th,W}	s	44.0	
Thermal time constant of motor	T _{th,M}	min	18.5	
Mass	m _{mot}	kg	4.7	5.4
Holding brake				
Holding torque	M ₄	Nm	0	5.00
Rated voltage	U _N	V	0	24
Rated current	I _N	A	0	0.63
Maximum connection time	t ₁	ms	0	30
Maximum disconnection time	t ₂	ms	0	45
1) For tolerance details refer to chapter 6.4 Tolerances			Latest amendment: 2017-05-05	

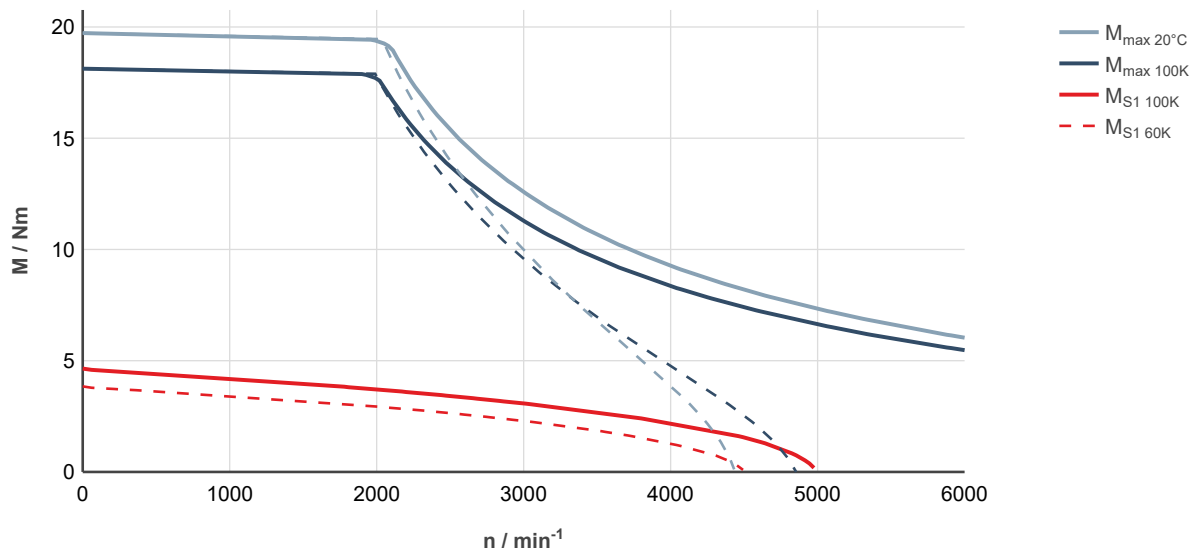

Fig. 44: MS2N04-D0BQN-___0-___-__, ctrlX DRIVE, uncontrolled supply 3 × AC 400 V

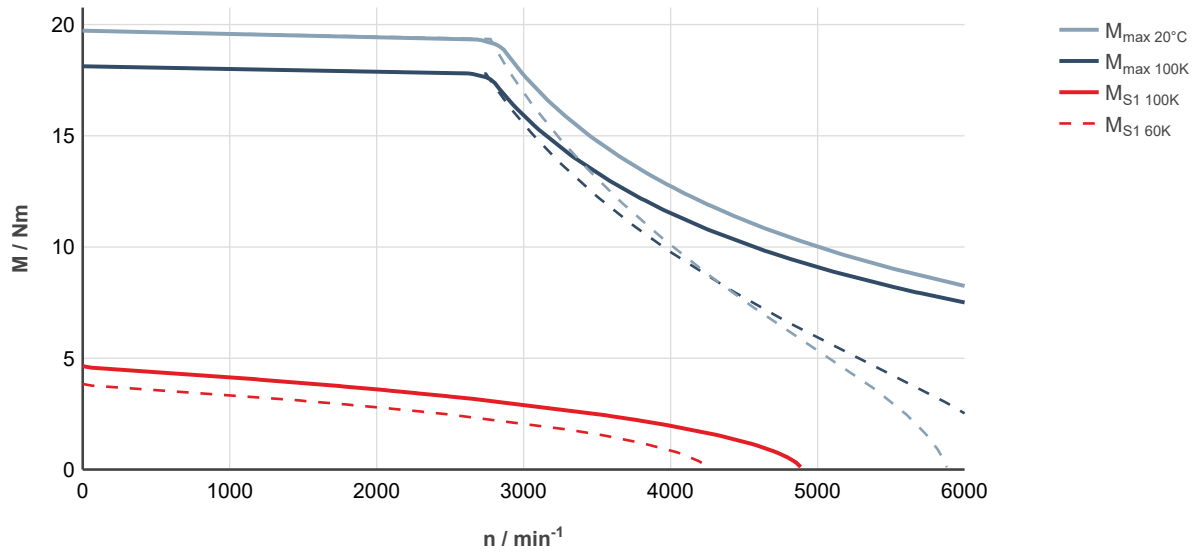
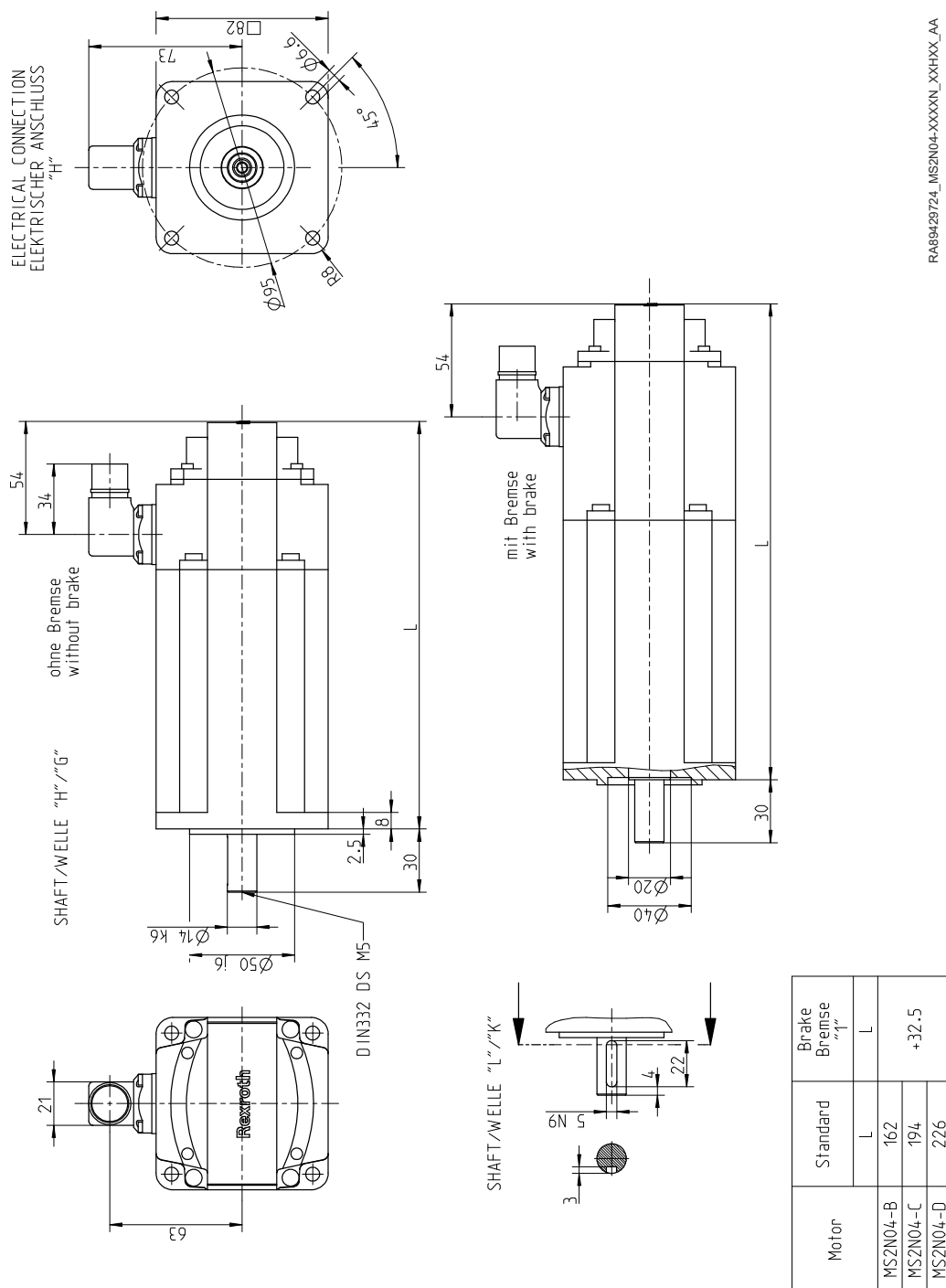

Fig. 45: MS2N04-D0BQN-___0-___-__, ctrlX DRIVE, controlled supply 3 × AC 400 ... 480 V

7.2.2 MS2N04 Self-cooling specification



RA89429724_MS2N04-XXXXN_XXHXX_AA

Fig. 46: MS2N04-XXXXN_XXHXX

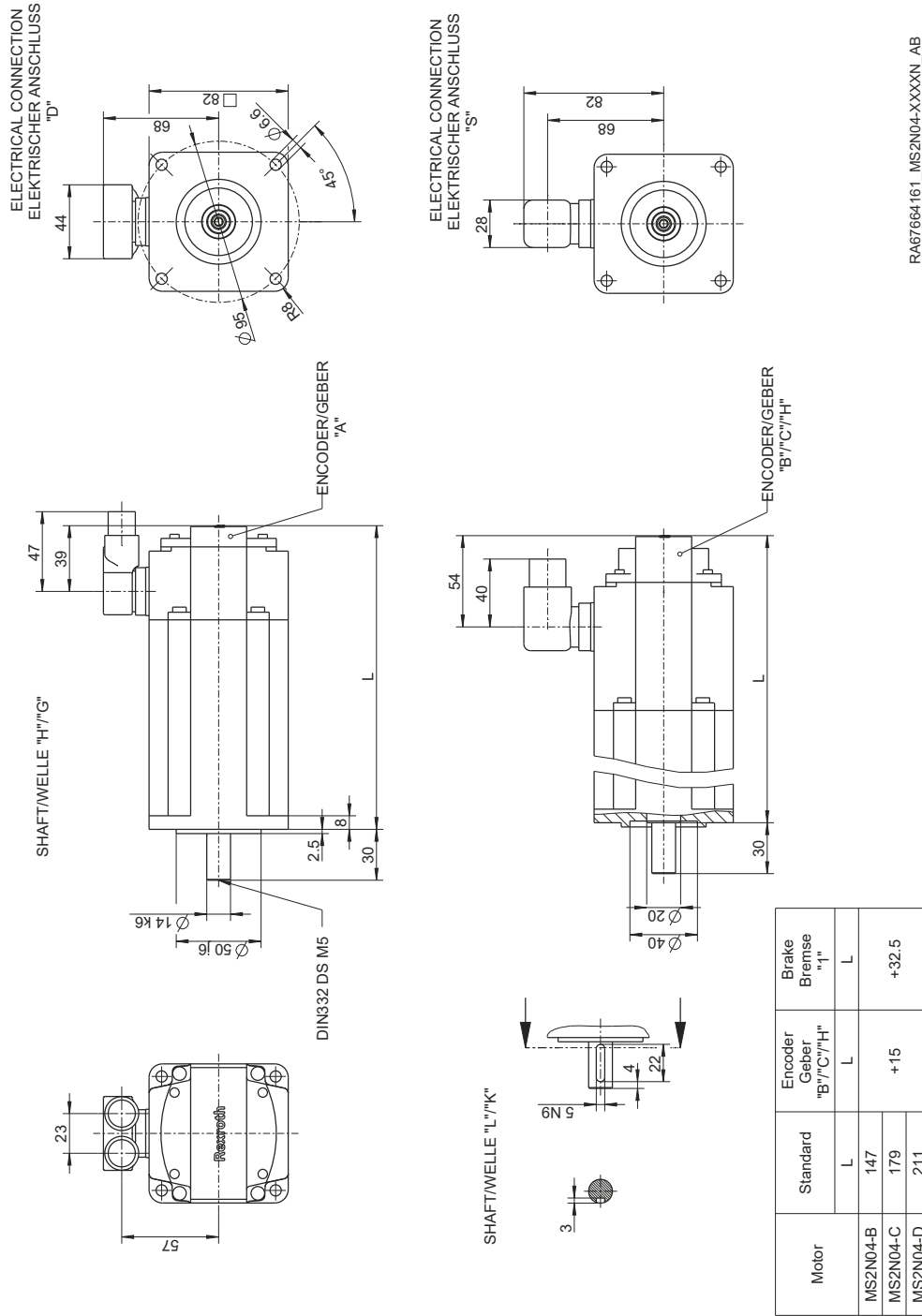

RA67664161_MS2N04-XXXXN_AB

Fig. 47: MS2N04-XXXXN

7.2.3 MS2N04 Axial force

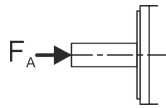

Axial forces F_A are permissible without limitation up to 30 N. Higher axial forces only after a detailed dimensioning by your distribution partner at Bosch Rexroth. For evaluation purposes, please specify the following information:

- Axial and radial force with force application point
- Installation position (horizontal, vertical with the shaft end pointing to the top or bottom)
- Mean speed

7.2.4 MS2N04 Radial force

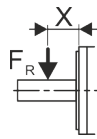

The permissible radial force F_R is specified in distance x from the shaft shoulder, depending on the mean speed in the following diagram.

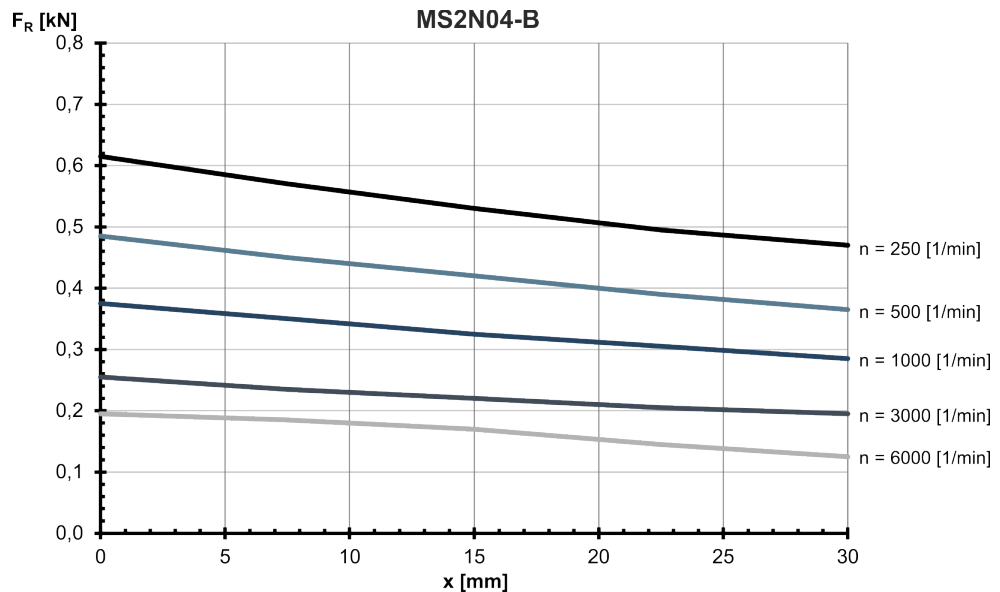

Fig. 48: MS2N04-B: Radial force in distance x from the shaft shoulder at a nominal bearing service life of $L_{h10} = 30000$ h

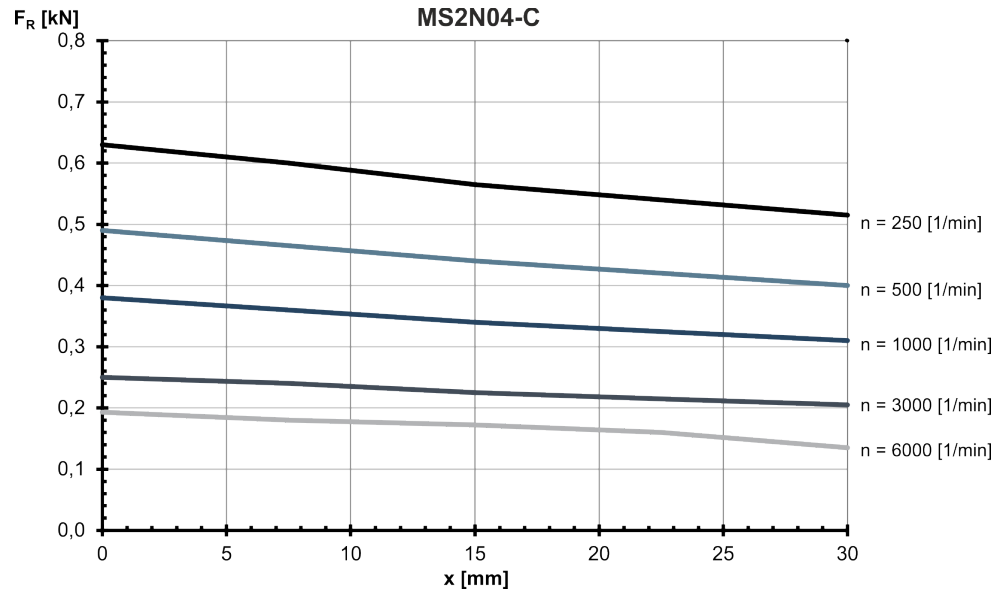

Fig. 49: MS2N04-C: Radial force in distance x from the shaft shoulder at a nominal bearing service life of $L_{h10} = 30000$ h

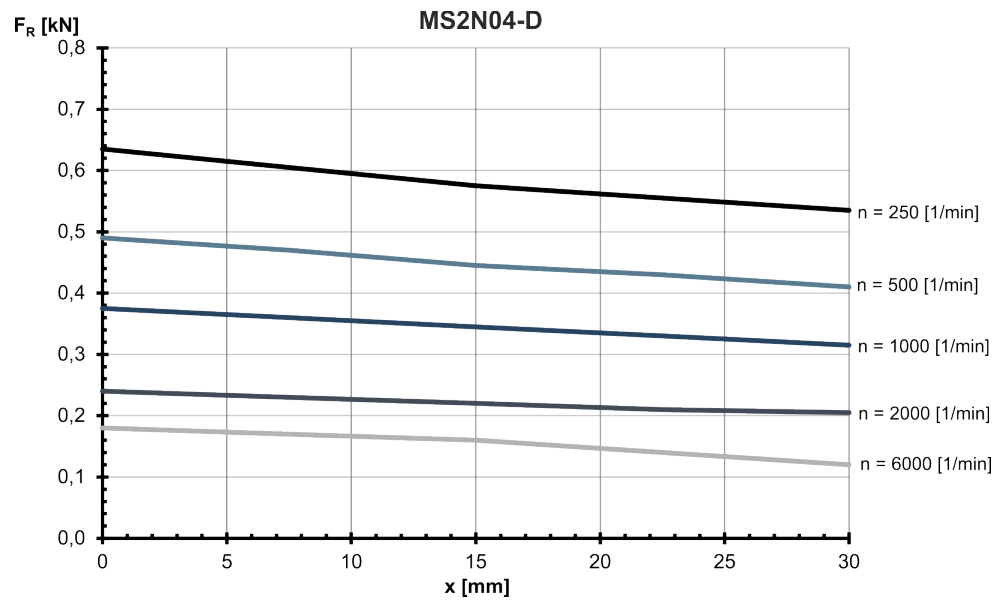

Fig. 50: MS2N04-D: Radial force in distance x from the shaft shoulder at a nominal bearing service life of $L_{h10} = 30000$ h

7.3 MS2N05 Technical data

7.3.1 Self-cooling

MS2N05-B0BNN

Designation	Symbol	Unit	MS2N05-B0BNN-__0-_N	MS2N05-B0BNN-__1-_N
Standstill torque - 60K ¹⁾	M _{0 60K}	Nm	3.75	
Standstill current - 60K	I _{0 60K}	A	2.29	
Standstill torque - 100K ¹⁾	M _{0 100K}	Nm	4.45	
Standstill current - 100K	I _{0 100K}	A	2.75	
Moment of inertia of rotor ¹⁾	J _{rot}	kg*m ²	0.00017	0.00028
Rated speed - 100K	n _{N 100K}	1/min	2850	
Rated torque - 100K ¹⁾	M _{N 100K}	Nm	3.72	
Rated current - 100K	I _{N 100K}	A	2.36	
Rated power - 100K ¹⁾	P _{N 100K}	kW	1.11	
Maximum torque 20 °C (cold) ¹⁾	M _{max 20°C}	Nm	11.5	
Maximum torque 100K (warm) ¹⁾	M _{max 100K}	Nm	10.6	
Maximum current	I _{max(rms)}	A	8.4	
Maximum speed (electrical)	n _{max el}	1/min	6000	
Maximum speed (mechanical)	n _{max mech}	1/min	6000	
Number of pole pairs	p		5	
Torque constant at 20 °C ¹⁾	K _m	Nm/A	1.78	
Voltage constant at 20 °C ¹⁾	K _E	V/1000 min ⁻¹	108.4	
Winding resistance at 20 °C	R ₁₂	Ohm	10.6	
Winding inductance	L _{12,min}	mH	56.4	
Leakage capacitance of the component	C _{ab}	nF	1.3	
Thermal time constant of winding	T _{th,W}	s	21.2	
Thermal time constant of motor	T _{th,M}	min	12.7	
Mass	m _{mot}	kg	4.0	5.1
Holding brake				
Holding torque	M ₄	Nm	0	10.00
Rated voltage	U _N	V	0	24
Rated current	I _N	A	0	0.73
Maximum connection time	t ₁	ms	0	30
Maximum disconnection time	t ₂	ms	0	80

1) For tolerance details refer to [chapter 6.4 Tolerances](#)

Latest amendment: 2016-07-13

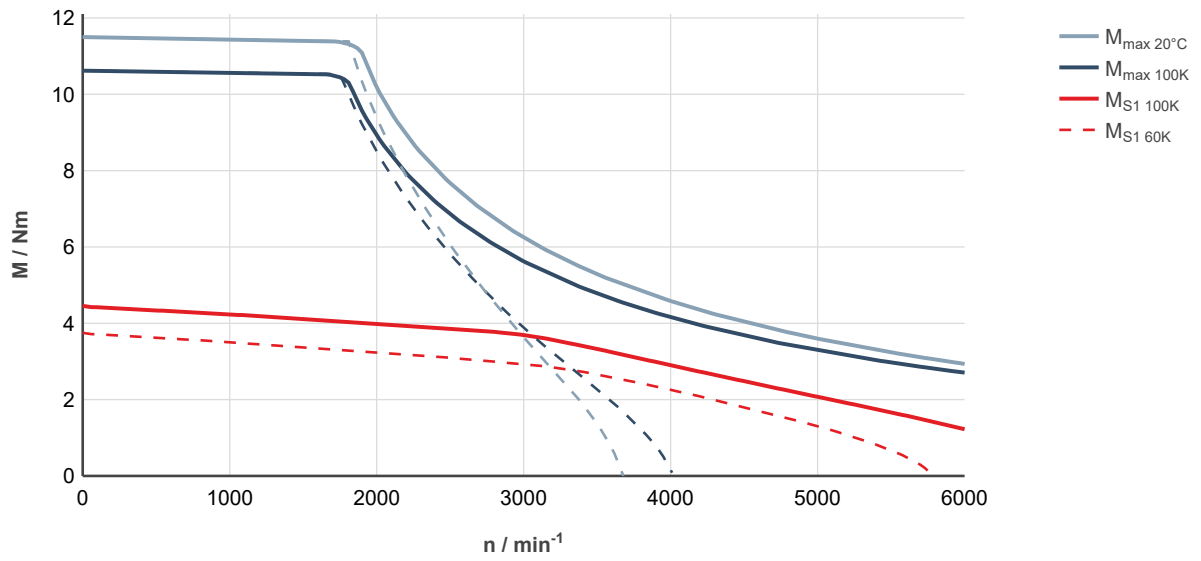

Fig. 51: MS2N05-B0BNN-___0-___-__, ctrlX DRIVE, uncontrolled supply 3 × AC 400 V

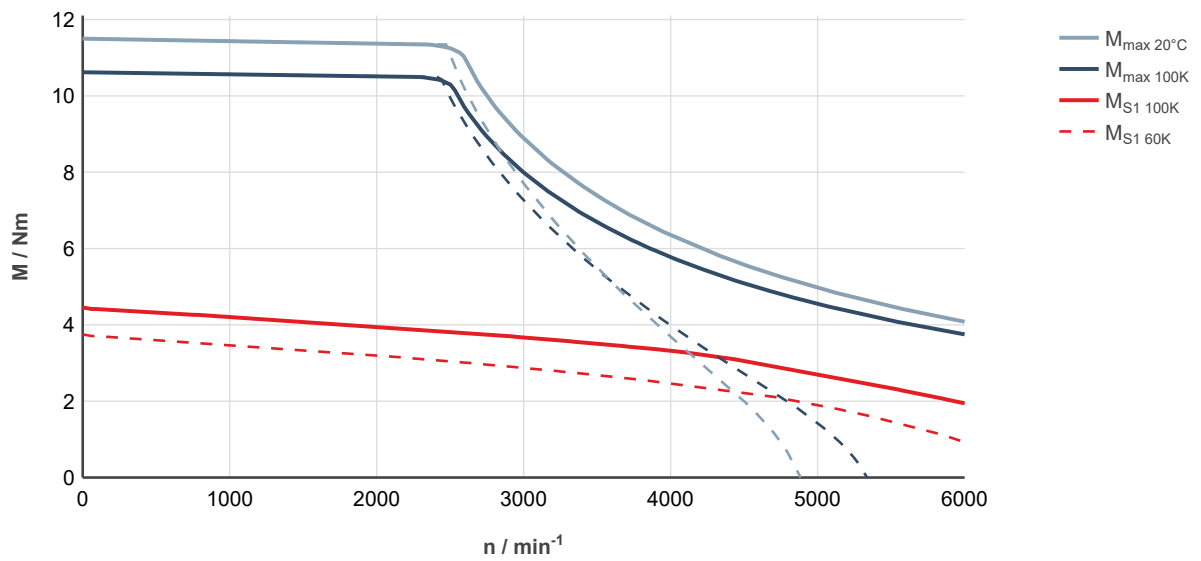

Fig. 52: MS2N05-B0BNN-___0-___-__, ctrlX DRIVE, controlled supply 3 × AC 400 ... 480 V

MS2N05-B0BTN

Designation	Symbol	Unit	MS2N05-B0BTN-__0-_N	MS2N05-B0BTN-__1-_N
Standstill torque - 60K ¹⁾	M _{0 60K}	Nm	3.75	
Standstill current - 60K	I _{0 60K}	A	4.55	
Standstill torque - 100K ¹⁾	M _{0 100K}	Nm	4.45	
Standstill current - 100K	I _{0 100K}	A	5.45	
Moment of inertia of rotor ¹⁾	J _{rot}	kg*m ²	0.00017	0.00028
Rated speed - 100K	n _{N 100K}	1/min	5410	
Rated torque - 100K ¹⁾	M _{N 100K}	Nm	2.37	
Rated current - 100K	I _{N 100K}	A	3.12	
Rated power - 100K ¹⁾	P _{N 100K}	kW	1.34	
Maximum torque 20 °C (cold) ¹⁾	M _{max 20°C}	Nm	11.5	
Maximum torque 100K (warm) ¹⁾	M _{max 100K}	Nm	10.6	
Maximum current	I _{max(rms)}	A	16.8	
Maximum speed (electrical)	n _{max el}	1/min	6000	
Maximum speed (mechanical)	n _{max mech}	1/min	6000	
Number of pole pairs	p		5	
Torque constant at 20 °C ¹⁾	K _m	Nm/A	0.89	
Voltage constant at 20 °C ¹⁾	K _E	V/1000 min ⁻¹	54.2	
Winding resistance at 20 °C	R ₁₂	Ohm	2.7	
Winding inductance	L _{12,min}	mH	14.09	
Leakage capacitance of the component	C _{ab}	nF	1.21	
Thermal time constant of winding	T _{th,W}	s	21.2	
Thermal time constant of motor	T _{th,M}	min	12.7	
Mass	m _{mot}	kg	4.0	5.1
Holding brake				
Holding torque	M ₄	Nm	0	10.00
Rated voltage	U _N	V	0	24
Rated current	I _N	A	0	0.73
Maximum connection time	t ₁	ms	0	30
Maximum disconnection time	t ₂	ms	0	80

1) For tolerance details refer to [chapter 6.4 Tolerances](#)

Latest amendment: 2019-05-09

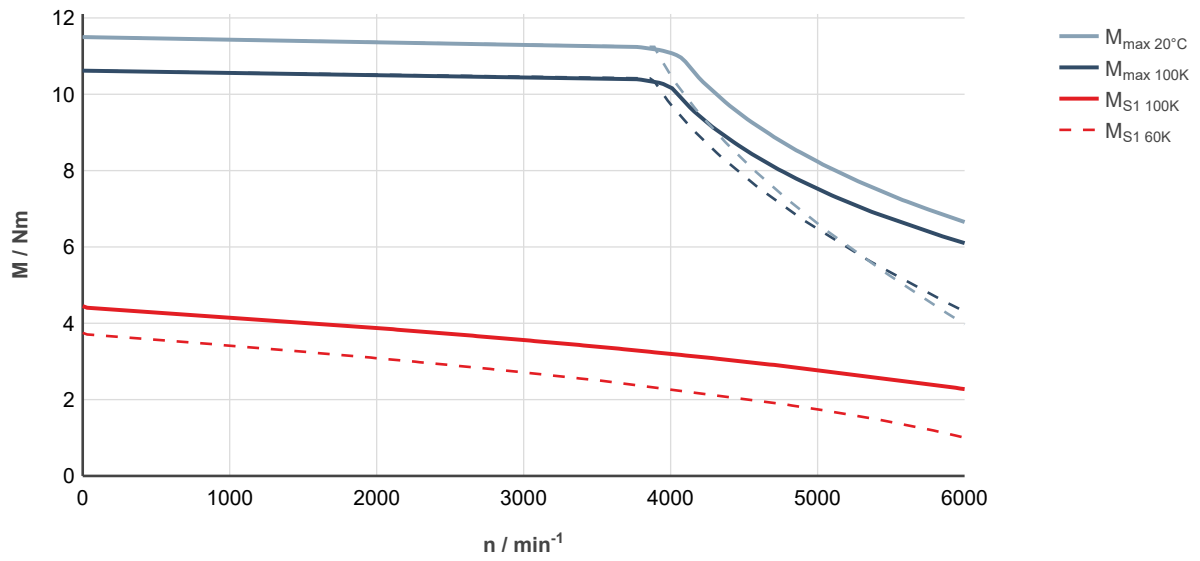

Fig. 53: MS2N05-B0BTN-___0-___-__, ctrlX DRIVE, uncontrolled supply 3 × AC 400 V

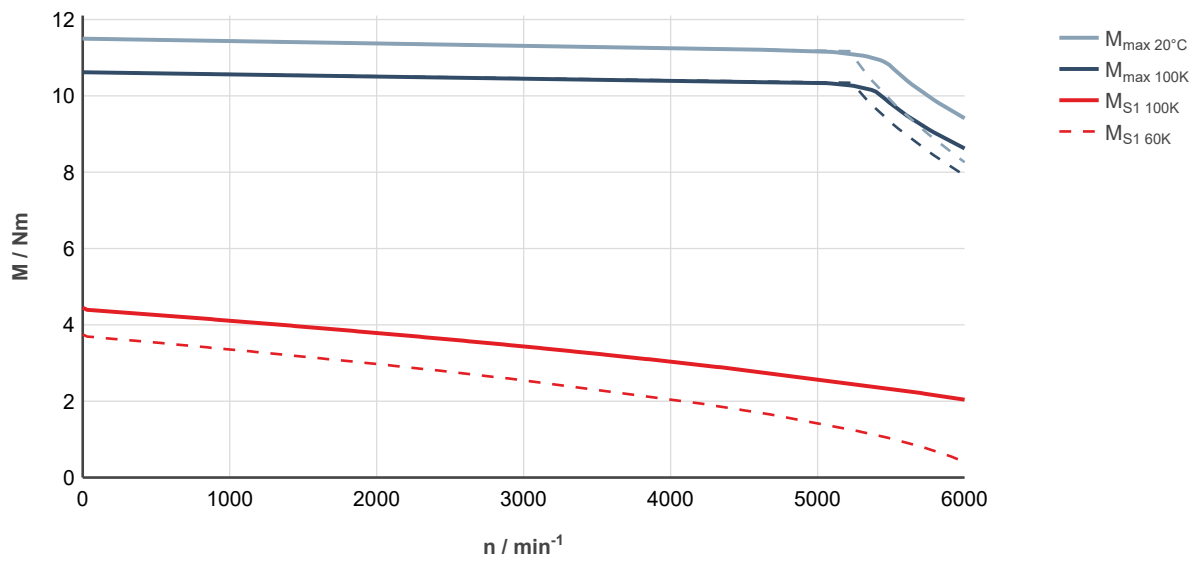

Fig. 54: MS2N05-B0BTN-___0-___-__, ctrlX DRIVE, controlled supply 3 × AC 400 ... 480 V

MS2N05-C0BNN

Designation	Symbol	Unit	MS2N05-C0BNN-__0-_N	MS2N05-C0BNN-__1-_N
Standstill torque - 60K ¹⁾	M _{0 60K}	Nm	6.1	
Standstill current - 60K	I _{0 60K}	A	3.53	
Standstill torque - 100K ¹⁾	M _{0 100K}	Nm	7.15	
Standstill current - 100K	I _{0 100K}	A	4.16	
Moment of inertia of rotor ¹⁾	J _{rot}	kg*m ²	0.00029	0.00040
Rated speed - 100K	n _{N 100K}	1/min	2990	
Rated torque - 100K ¹⁾	M _{N 100K}	Nm	5.45	
Rated current - 100K	I _{N 100K}	A	3.3	
Rated power - 100K ¹⁾	P _{N 100K}	kW	1.71	
Maximum torque 20 °C (cold) ¹⁾	M _{max 20°C}	Nm	22.6	
Maximum torque 100K (warm) ¹⁾	M _{max 100K}	Nm	20.8	
Maximum current	I _{max(rms)}	A	15.1	
Maximum speed (electrical)	n _{max el}	1/min	6000	
Maximum speed (mechanical)	n _{max mech}	1/min	6000	
Number of pole pairs	p		5	
Torque constant at 20 °C ¹⁾	K _m	Nm/A	1.85	
Voltage constant at 20 °C ¹⁾	K _E	V/1000 min ⁻¹	112.7	
Winding resistance at 20 °C	R ₁₂	Ohm	5.0	
Winding inductance	L _{12,min}	mH	30.3	
Leakage capacitance of the component	C _{ab}	nF	1.77	
Thermal time constant of winding	T _{th,W}	s	36.2	
Thermal time constant of motor	T _{th,M}	min	16.0	
Mass	m _{mot}	kg	5.9	7.0
Holding brake				
Holding torque	M ₄	Nm	0	10.00
Rated voltage	U _N	V	0	24
Rated current	I _N	A	0	0.73
Maximum connection time	t ₁	ms	0	30
Maximum disconnection time	t ₂	ms	0	80

1) For tolerance details refer to [chapter 6.4 Tolerances](#)

Latest amendment: 2016-07-13

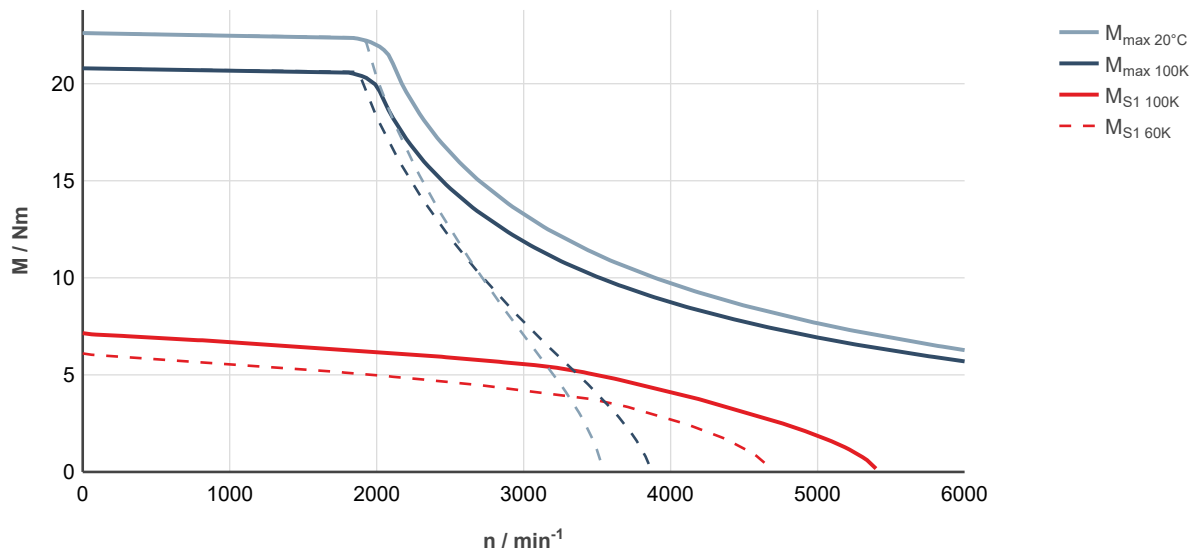

Fig. 55: MS2N05-C0BNN-___0-___-_, ctrlX DRIVE, uncontrolled supply 3 × AC 400 V

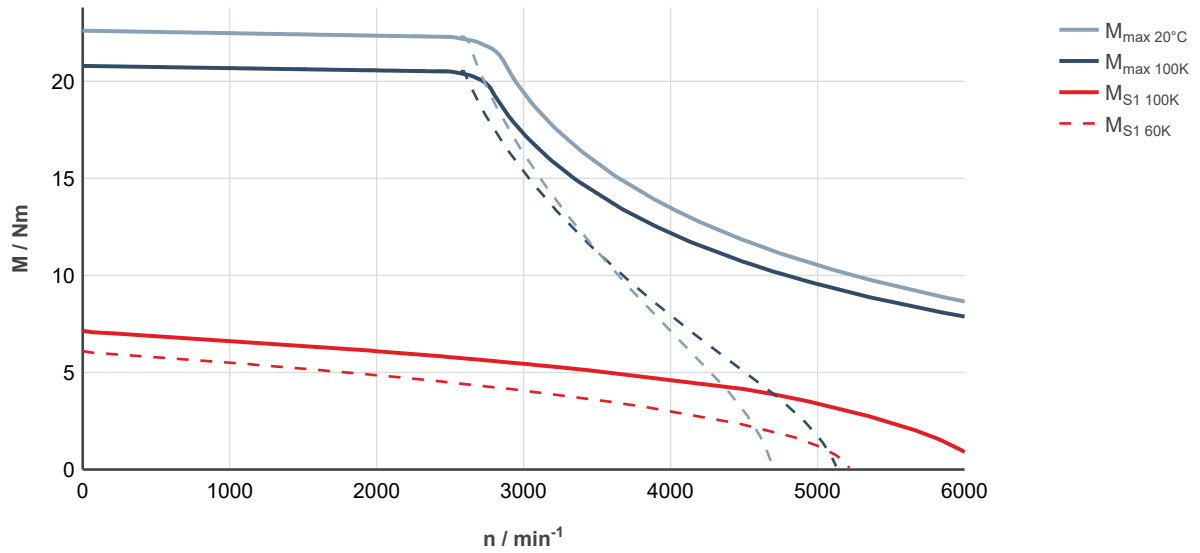

Fig. 56: MS2N05-C0BNN-___0-___-_, ctrlX DRIVE, controlled supply 3 × AC 400 ... 480 V

MS2N05-C0BTN

Designation	Symbol	Unit	MS2N05-C0BTN-__0-_N	MS2N05-C0BTN-__1-_N
Standstill torque - 60K ¹⁾	M _{0 60K}	Nm	6.10	
Standstill current - 60K	I _{0 60K}	A	7.1	
Standstill torque - 100K ¹⁾	M _{0 100K}	Nm	7.15	
Standstill current - 100K	I _{0 100K}	A	8.35	
Moment of inertia of rotor ¹⁾	J _{rot}	kg*m ²	0.00029	0.00040
Rated speed - 100K	n _{N 100K}	1/min	4090	
Rated torque - 100K ¹⁾	M _{N 100K}	Nm	3.52	
Rated current - 100K	I _{N 100K}	A	4.43	
Rated power - 100K ¹⁾	P _{N 100K}	kW	1.51	
Maximum torque 20 °C (cold) ¹⁾	M _{max 20°C}	Nm	22.6	
Maximum torque 100K (warm) ¹⁾	M _{max 100K}	Nm	20.8	
Maximum current	I _{max(rms)}	A	30.2	
Maximum speed (electrical)	n _{max el}	1/min	6000	
Maximum speed (mechanical)	n _{max mech}	1/min	6000	
Number of pole pairs	p		5	
Torque constant at 20 °C ¹⁾	K _m	Nm/A	0.93	
Voltage constant at 20 °C ¹⁾	K _E	V/1000 min ⁻¹	56.3	
Winding resistance at 20 °C	R ₁₂	Ohm	1.26	
Winding inductance	L _{12,min}	mH	7.6	
Leakage capacitance of the component	C _{ab}	nF	1.5	
Thermal time constant of winding	T _{th,W}	s	36.2	
Thermal time constant of motor	T _{th,M}	min	16.0	
Mass	m _{mot}	kg	5.9	7.0
Holding brake				
Holding torque	M ₄	Nm	0	10.00
Rated voltage	U _N	V	0	24
Rated current	I _N	A	0	0.73
Maximum connection time	t ₁	ms	0	30
Maximum disconnection time	t ₂	ms	0	80

1) For tolerance details refer to [chapter 6.4 Tolerances](#) Latest amendment: 2016-07-13

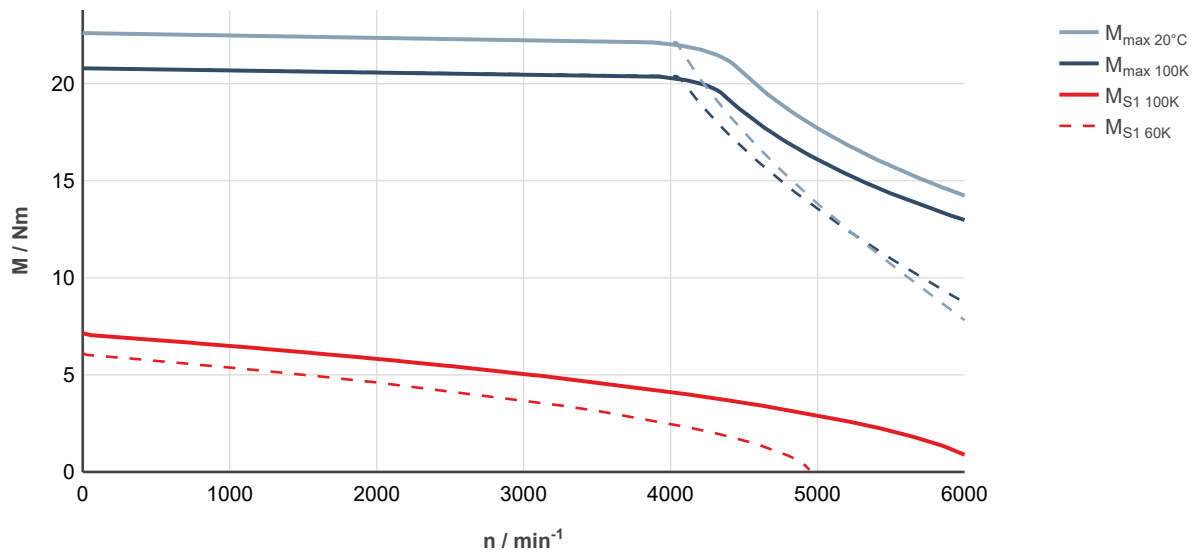

Fig. 57: MS2N05-C0BTN-___0-___-__, ctrlX DRIVE, uncontrolled supply 3 × AC 400 V

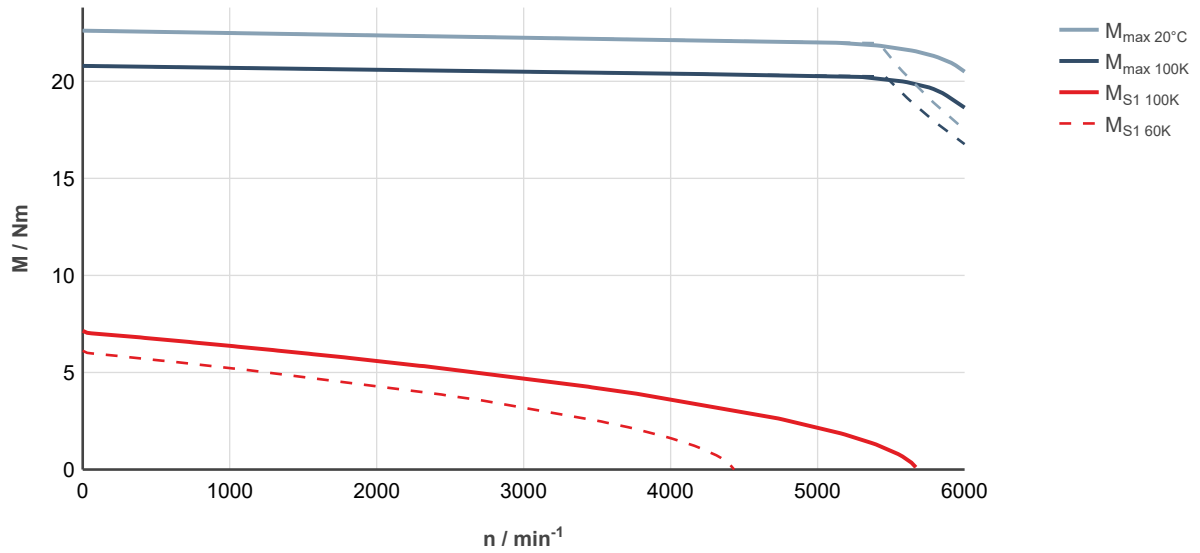

Fig. 58: MS2N05-C0BTN-___0-___-__, ctrlX DRIVE, controlled supply 3 × AC 400 ... 480 V

MS2N05-D0BHN

Designation	Symbol	Unit	MS2N05-D0BHN-__0-_N	MS2N05-D0BHN-__1-_N
Standstill torque - 60K ¹⁾	M _{0 60K}	Nm	7.9	
Standstill current - 60K	I _{0 60K}	A	3.05	
Standstill torque - 100K ¹⁾	M _{0 100K}	Nm	9.35	
Standstill current - 100K	I _{0 100K}	A	3.63	
Moment of inertia of rotor ¹⁾	J _{rot}	kg*m ²	0.00040	0.00051
Rated speed - 100K	n _{N 100K}	1/min	2000	
Rated torque - 100K ¹⁾	M _{N 100K}	Nm	7.55	
Rated current - 100K	I _{N 100K}	A	3.03	
Rated power - 100K ¹⁾	P _{N 100K}	kW	1.58	
Maximum torque 20 °C (cold) ¹⁾	M _{max 20°C}	Nm	34.0	
Maximum torque 100K (warm) ¹⁾	M _{max 100K}	Nm	31.3	
Maximum current	I _{max(rms)}	A	15.15	
Maximum speed (electrical)	n _{max el}	1/min	4000	
Maximum speed (mechanical)	n _{max mech}	1/min	6000	
Number of pole pairs	p		5	
Torque constant at 20 °C ¹⁾	K _m	Nm/A	2.79	
Voltage constant at 20 °C ¹⁾	K _E	V/1000 min ⁻¹	169.6	
Winding resistance at 20 °C	R ₁₂	Ohm	6.87	
Winding inductance	L _{12,min}	mH	46.74	
Leakage capacitance of the component	C _{ab}	nF	3.27	
Thermal time constant of winding	T _{th,W}	s	45.8	
Thermal time constant of motor	T _{th,M}	min	18.5	
Mass	m _{mot}	kg	7.3	8.4
Holding brake				
Holding torque	M ₄	Nm	0	10.00
Rated voltage	U _N	V	0	24
Rated current	I _N	A	0	0.73
Maximum connection time	t ₁	ms	0	30
Maximum disconnection time	t ₂	ms	0	80
1) For tolerance details refer to chapter 6.4 Tolerances			Latest amendment: 2016-07-13	

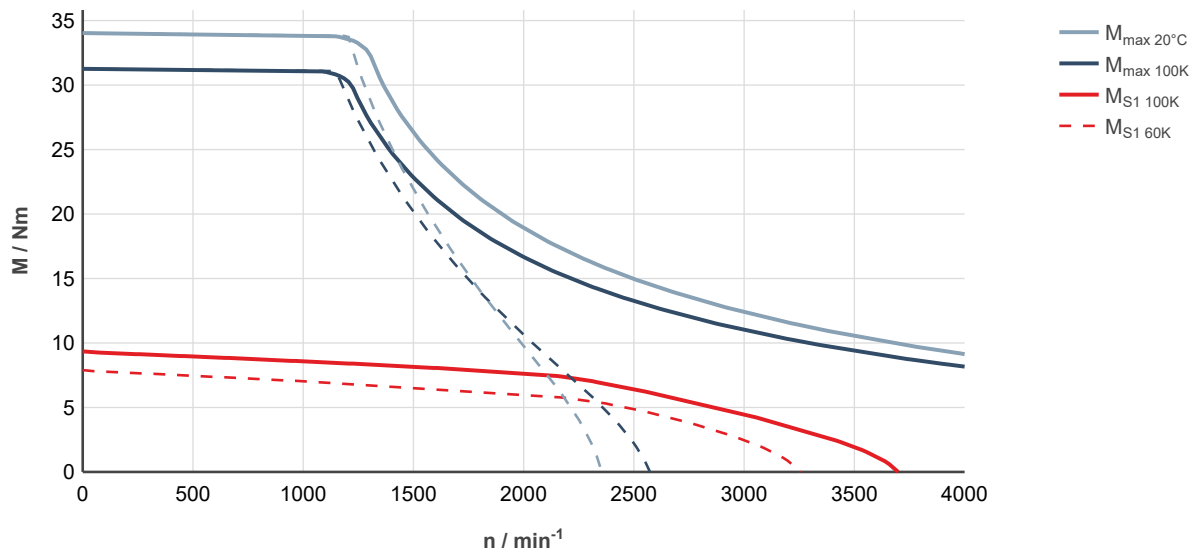

Fig. 59: MS2N05-D0BHN-___0-___-_, ctrlX DRIVE, uncontrolled supply 3 × AC 400 V

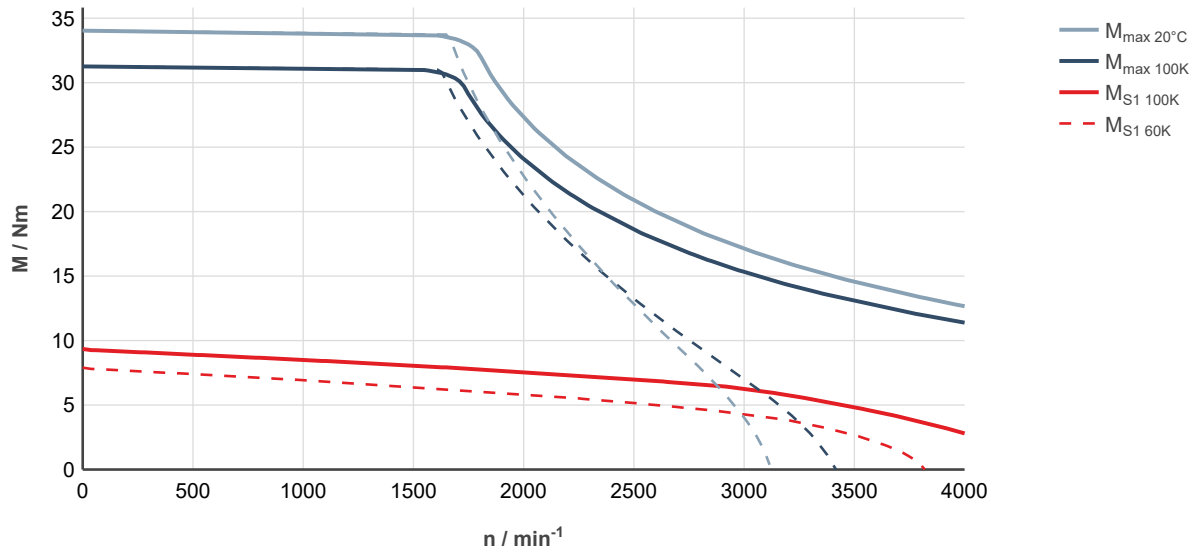

Fig. 60: MS2N05-D0BHN-___0-___-_, ctrlX DRIVE, controlled supply 3 × AC 400 ... 480 V

MS2N05-D0BRN

Designation	Symbol	Unit	MS2N05-D0BRN-__0-_N	MS2N05-D0BRN-__1-_N
Standstill torque - 60K ¹⁾	M _{0 60K}	Nm	7.9	
Standstill current - 60K	I _{0 60K}	A	6.05	
Standstill torque - 100K ¹⁾	M _{0 100K}	Nm	9.35	
Standstill current - 100K	I _{0 100K}	A	7.2	
Moment of inertia of rotor ¹⁾	J _{rot}	kg*m ²	0.00040	0.00051
Rated speed - 100K	n _{N 100K}	1/min	3510	
Rated torque - 100K ¹⁾	M _{N 100K}	Nm	4.74	
Rated current - 100K	I _{N 100K}	A	3.95	
Rated power - 100K ¹⁾	P _{N 100K}	kW	1.74	
Maximum torque 20 °C (cold) ¹⁾	M _{max 20°C}	Nm	34.0	
Maximum torque 100K (warm) ¹⁾	M _{max 100K}	Nm	31.3	
Maximum current	I _{max(rms)}	A	30.3	
Maximum speed (electrical)	n _{max el}	1/min	6000	
Maximum speed (mechanical)	n _{max mech}	1/min	6000	
Number of pole pairs	p		5	
Torque constant at 20 °C ¹⁾	K _m	Nm/A	1.4	
Voltage constant at 20 °C ¹⁾	K _E	V/1000 min ⁻¹	84.8	
Winding resistance at 20 °C	R ₁₂	Ohm	1.76	
Winding inductance	L _{12,min}	mH	11.18	
Leakage capacitance of the component	C _{ab}	nF	3.29	
Thermal time constant of winding	T _{th,W}	s	45.8	
Thermal time constant of motor	T _{th,M}	min	18.5	
Mass	m _{mot}	kg	7.3	8.4
Holding brake				
Holding torque	M ₄	Nm	0	10.00
Rated voltage	U _N	V	0	24
Rated current	I _N	A	0	0.73
Maximum connection time	t ₁	ms	0	30
Maximum disconnection time	t ₂	ms	0	80

1) For tolerance details refer to [chapter 6.4 Tolerances](#)

Latest amendment: 2016-07-13

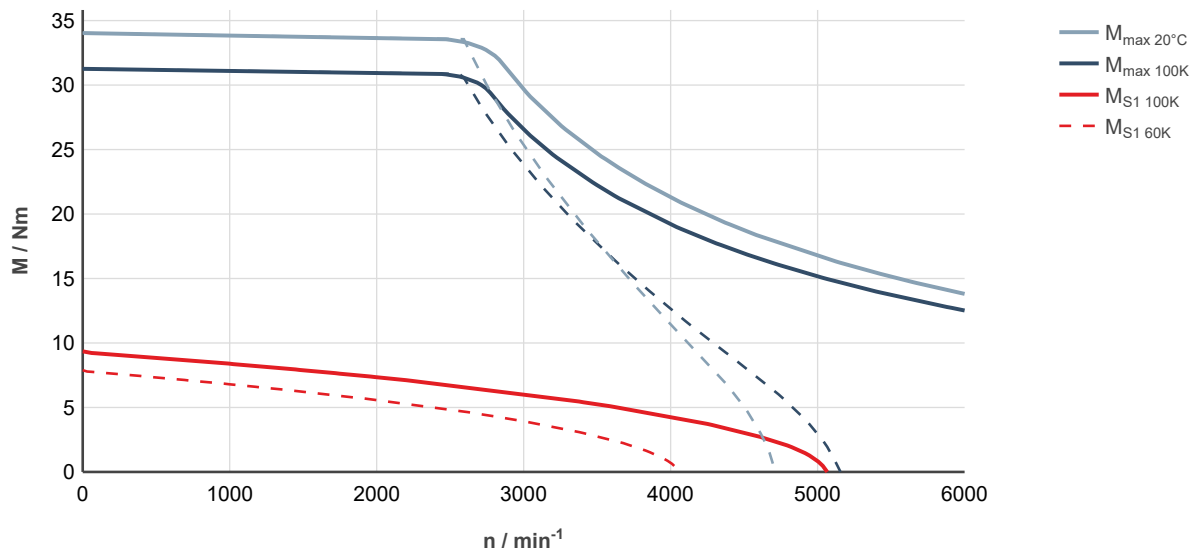

Fig. 61: MS2N05-D0BRN-___0-___-__, ctrlX DRIVE, uncontrolled supply 3 × AC 400 V

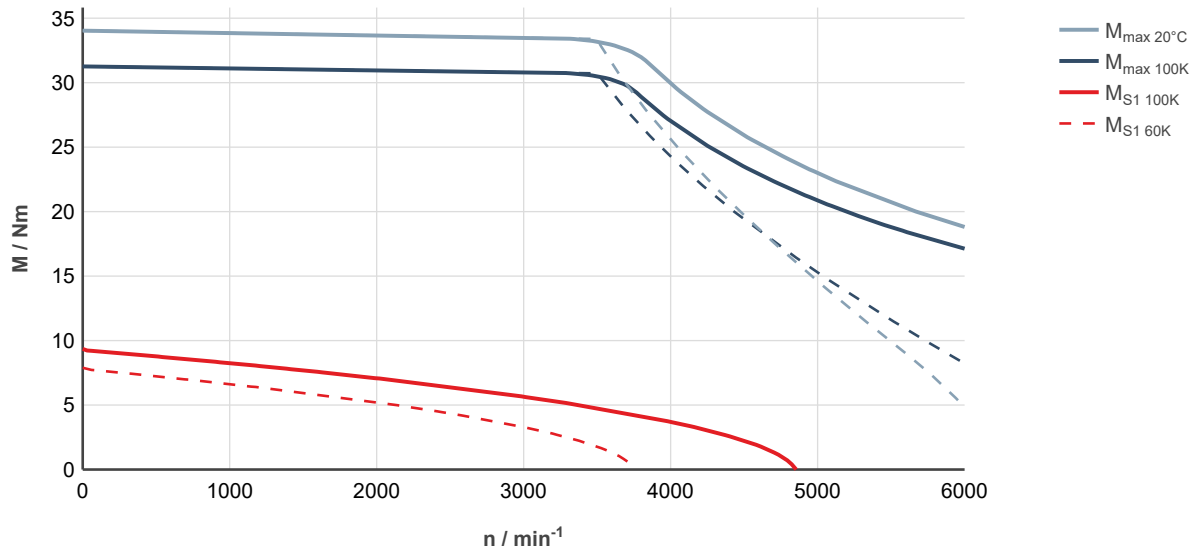

Fig. 62: MS2N05-D0BRN-___0-___-__, ctrlX DRIVE, controlled supply 3 × AC 400 ... 480 V

7.3.2 MS2N05 Self-cooling specification

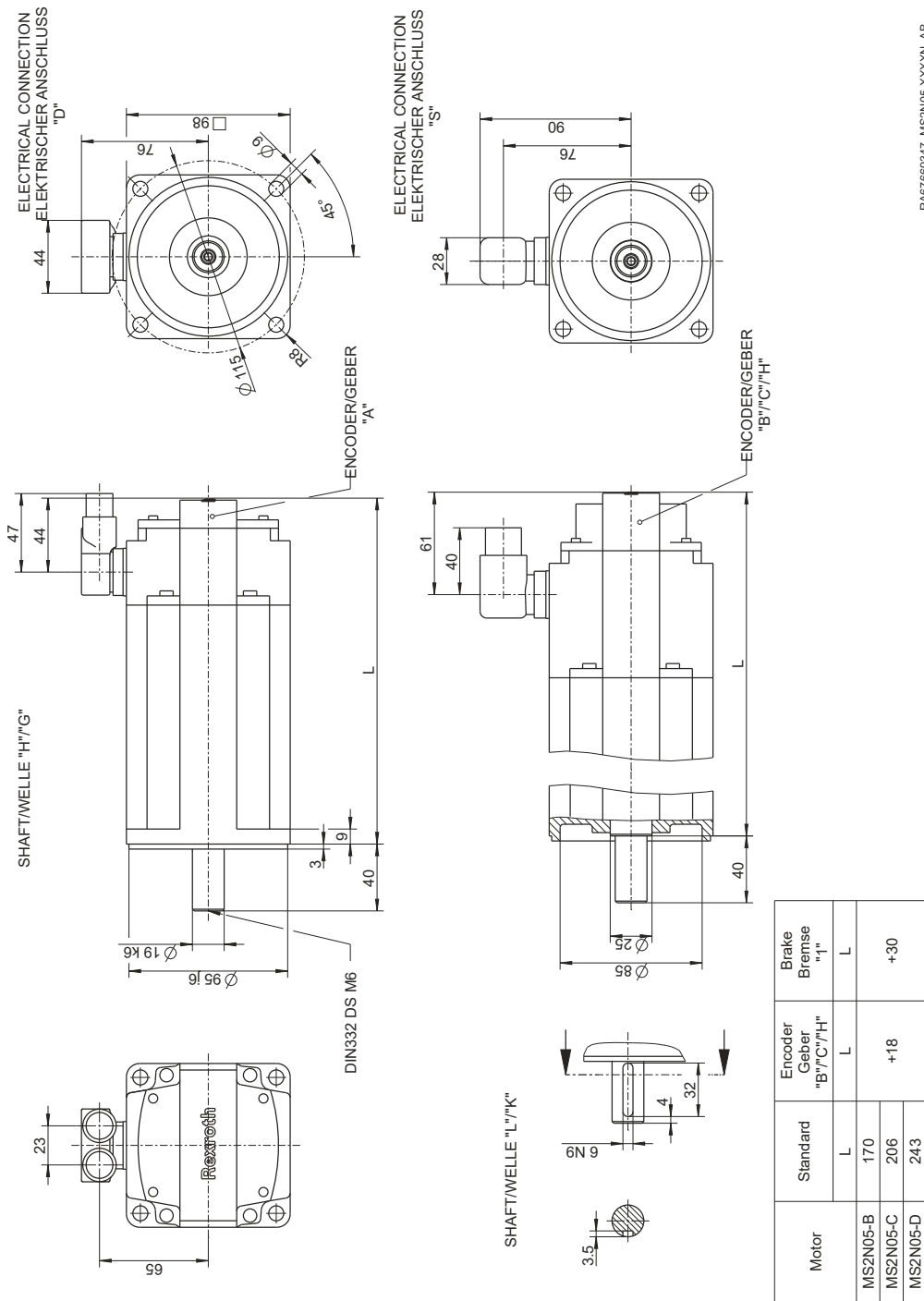
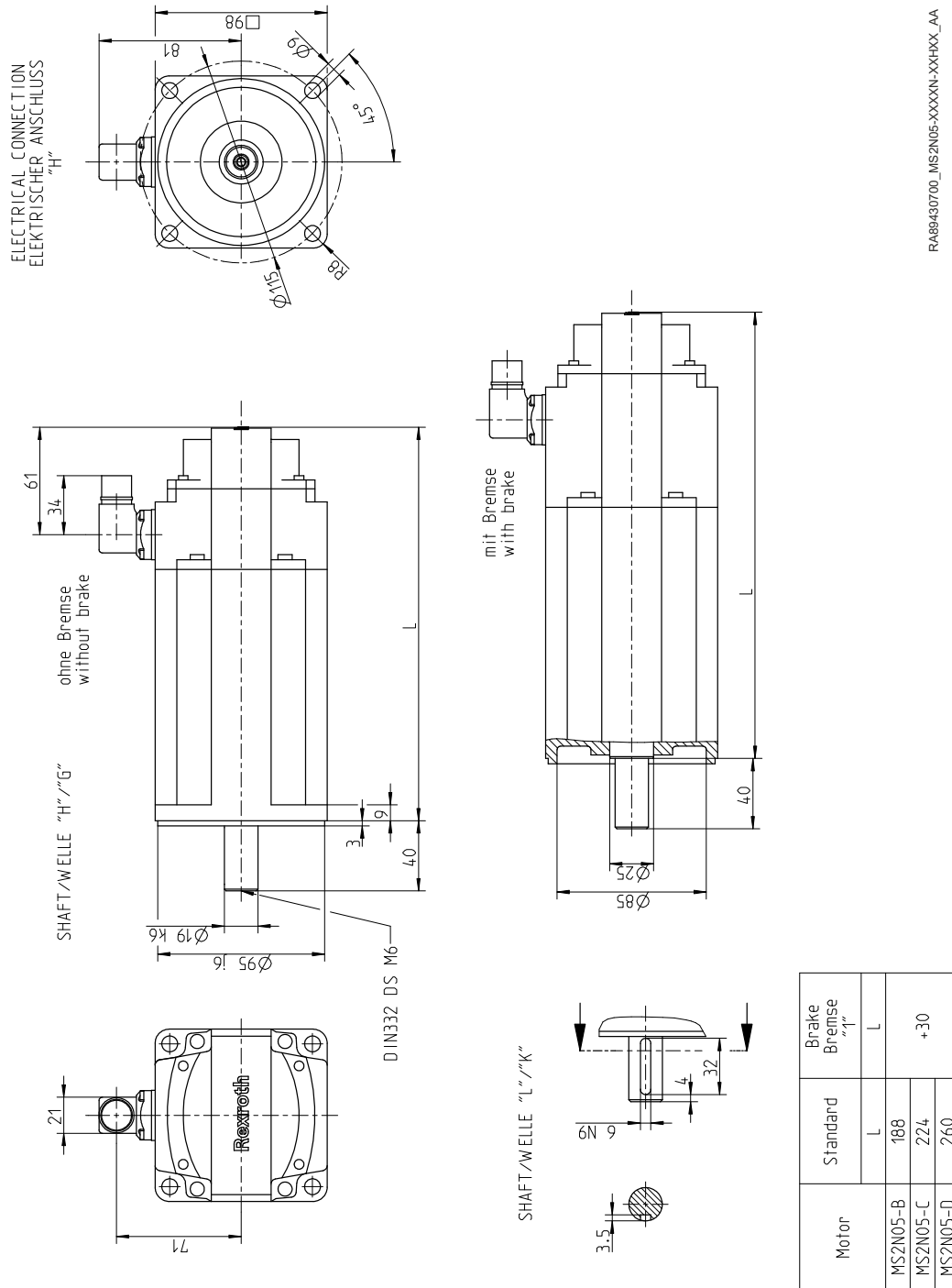

Fig. 63: MS2N05\ -XXXXN

RA67669347_MS2N05-XXXXN_AB



RA689430700_MS2N05-XXXXN-XXHXX_AA

Fig. 64: MS2N05\ -XXXXN\ -XXHXX

7.3.3 MS2N05 Axial force

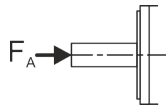

Axial forces F_A are permissible without limitation up to 40 N. Higher axial forces only after a detailed dimensioning by your distribution partner at Bosch Rexroth. For evaluation purposes, please specify the following information:

- Axial and radial force with force application point
- Installation position (horizontal, vertical with the shaft end pointing to the top or bottom)
- Mean speed

7.3.4 MS2N05 Radial force

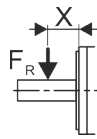

The permissible radial force F_R is specified in distance x from the shaft shoulder, depending on the mean speed in the following diagram.

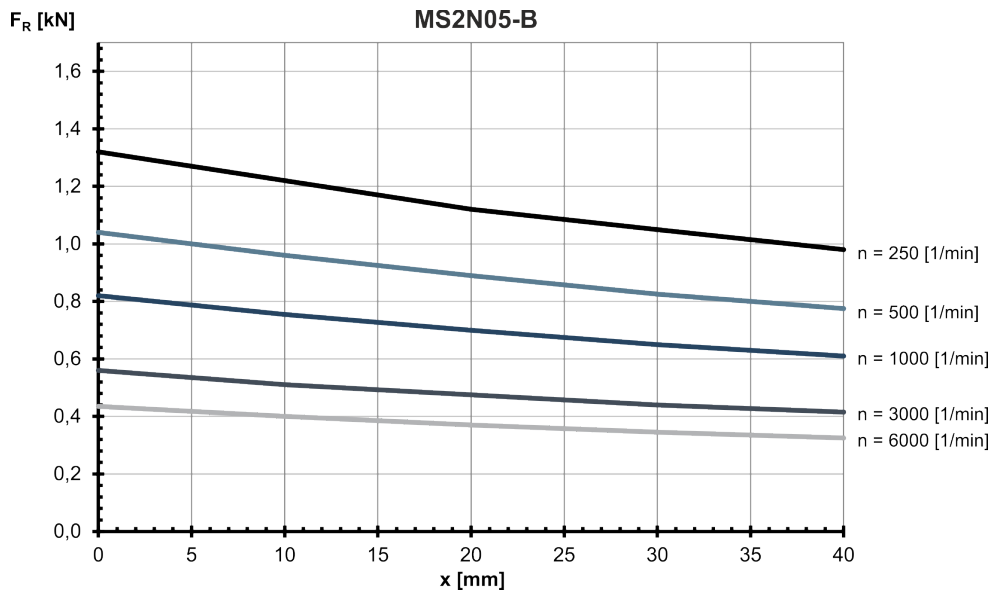

Fig. 65: MS2N05-B: Radial force in distance x from the shaft shoulder at a nominal bearing service life of $L_{h10} = 30000$ h

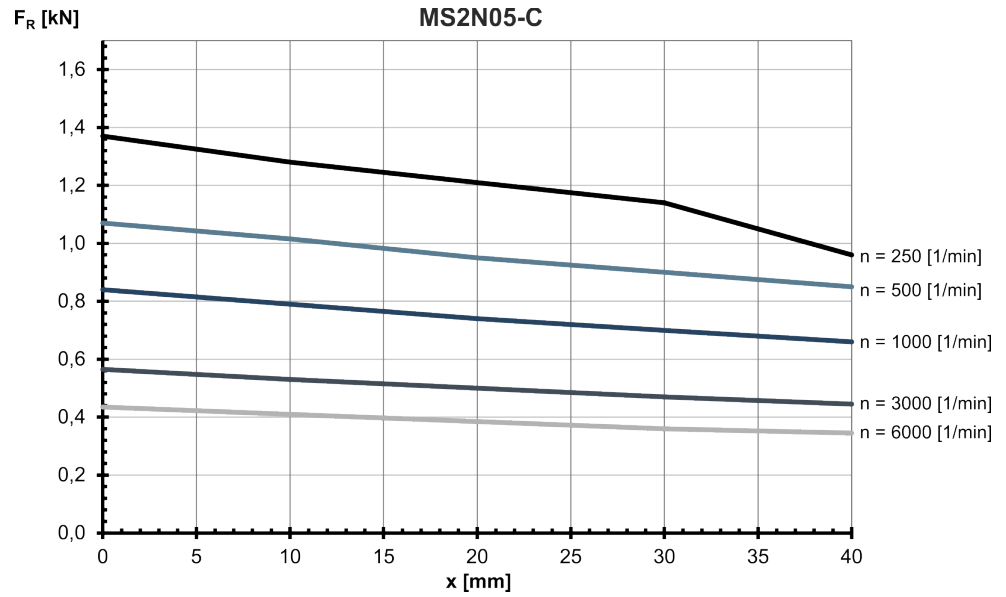

Fig. 66: MS2N05-C: Radial force in distance x from the shaft shoulder at a nominal bearing service life of $L_{h10} = 30000$ h

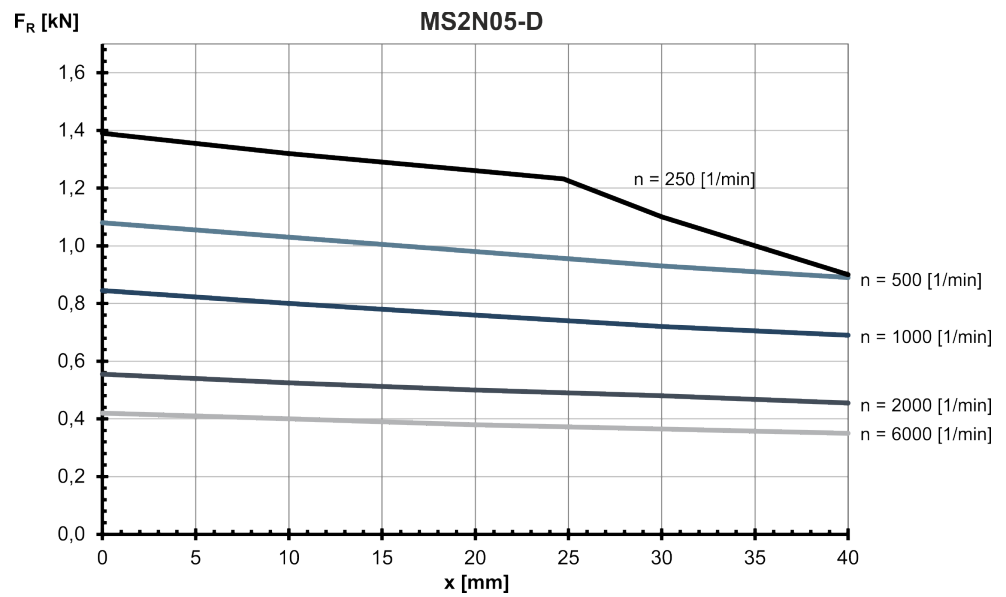

Fig. 67: MS2N05-D: Radial force in distance x from the shaft shoulder at a nominal bearing service life of $L_{h10} = 30000$ h

7.4 MS2N06 Technical data

7.4.1 Self-cooling

MS2N06-B1BNN

Designation	Symbol	Unit	MS2N06-B1BNN-__0-_N	MS2N06-B1BNN-__1-_N
Standstill torque - 60K ¹⁾	M _{0 60K}	Nm	3.25	
Standstill current - 60K	I _{0 60K}	A	2.22	
Standstill torque - 100K ¹⁾	M _{0 100K}	Nm	3.60	
Standstill current - 100K	I _{0 100K}	A	2.47	
Moment of inertia of rotor ¹⁾	J _{rot}	kg*m ²	0.00048	0.00059
Rated speed - 100K	n _{N 100K}	1/min	3000	
Rated torque - 100K ¹⁾	M _{N 100K}	Nm	2.71	
Rated current - 100K	I _{N 100K}	A	1.93	
Rated power - 100K ¹⁾	P _{N 100K}	kW	0.85	
Maximum torque 20 °C (cold) ¹⁾	M _{max 20°C}	Nm	10.2	
Maximum torque 100K (warm) ¹⁾	M _{max 100K}	Nm	9.45	
Maximum current	I _{max(rms)}	A	7.8	
Maximum speed (electrical)	n _{max el}	1/min	6000	
Maximum speed (mechanical)	n _{max mech}	1/min	6000	
Number of pole pairs	p		5	
Torque constant at 20 °C ¹⁾	K _m	Nm/A	1.62	
Voltage constant at 20 °C ¹⁾	K _E	V/1000 min ⁻¹	98.2	
Winding resistance at 20 °C	R ₁₂	Ohm	12.2	
Winding inductance	L _{12,min}	mH	52.4	
Leakage capacitance of the component	C _{ab}	nF	0.6	
Thermal time constant of winding	T _{th,W}	s	15.7	
Thermal time constant of motor	T _{th,M}	min	12.2	
Mass	m _{mot}	kg	5.1	6.2
Holding brake				
Holding torque	M ₄	Nm	0	10.00
Rated voltage	U _N	V	0	24
Rated current	I _N	A	0	0.73
Maximum connection time	t ₁	ms	0	30
Maximum disconnection time	t ₂	ms	0	80

1) For tolerance details refer to [chapter 6.4 Tolerances](#)

Latest amendment: 2017-08-09

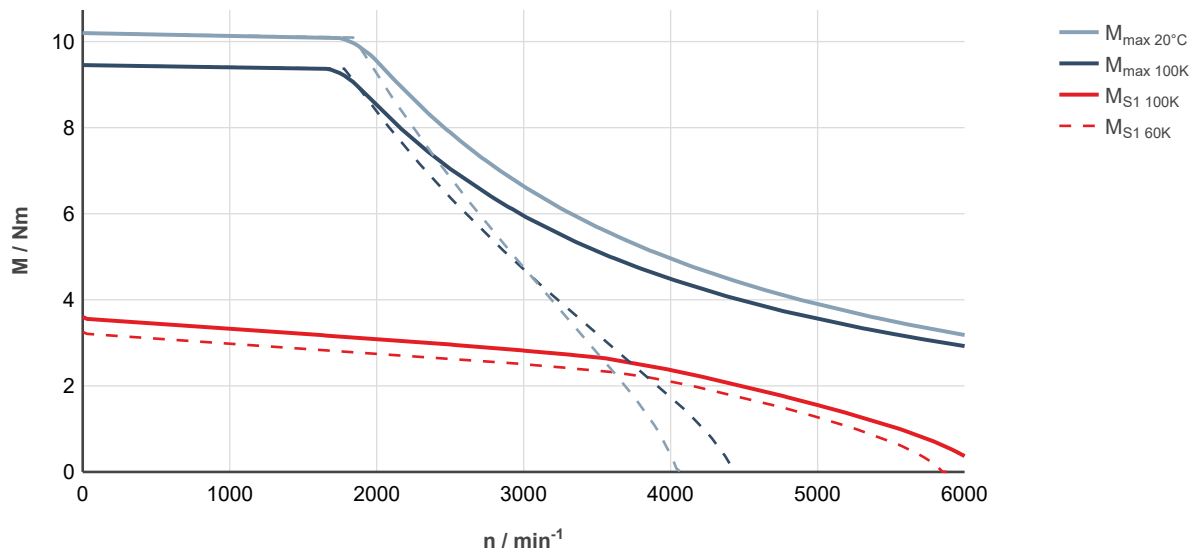

Fig. 68: MS2N06-B1BNN-___0-___-__, ctrlX DRIVE, uncontrolled supply 3 × AC 400 V

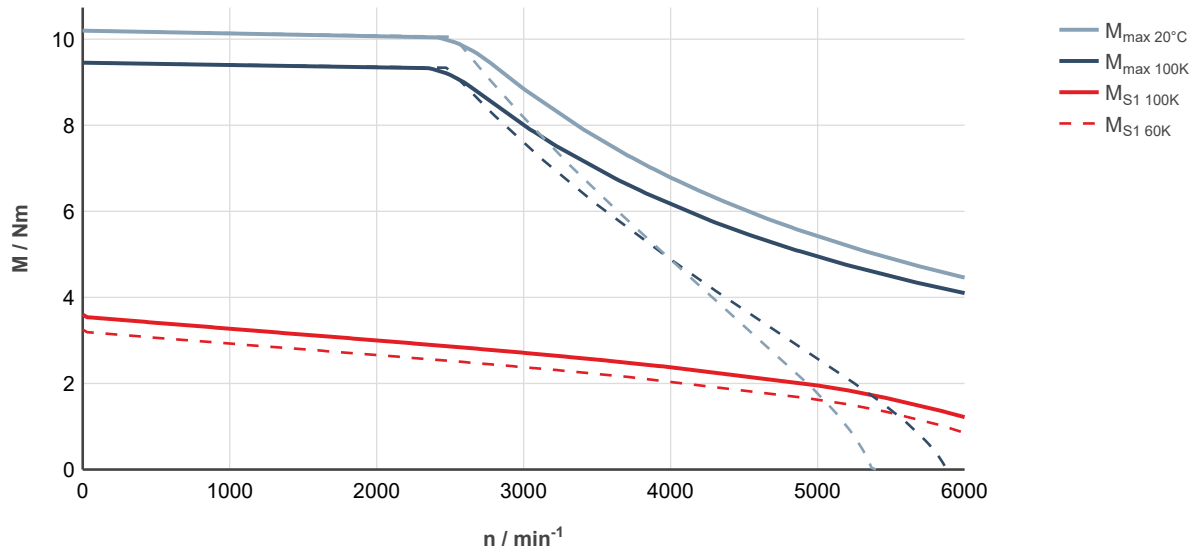

Fig. 69: MS2N06-B1BNN-___0-___-__, ctrlX DRIVE, controlled supply 3 × AC 400 ... 480 V

MS2N06-C0BNN

Designation	Symbol	Unit	MS2N06-C0BNN-__0-_N	MS2N06-C0BNN-__1-_N
Standstill torque - 60K ¹⁾	M _{0 60K}	Nm	6.0	
Standstill current - 60K	I _{0 60K}	A	3.75	
Standstill torque - 100K ¹⁾	M _{0 100K}	Nm	7.1	
Standstill current - 100K	I _{0 100K}	A	4.5	
Moment of inertia of rotor ¹⁾	J _{rot}	kg*m ²	0.00039	0.00050
Rated speed - 100K	n _{N 100K}	1/min	3000	
Rated torque - 100K ¹⁾	M _{N 100K}	Nm	5.4	
Rated current - 100K	I _{N 100K}	A	3.51	
Rated power - 100K ¹⁾	P _{N 100K}	kW	1.69	
Maximum torque 20 °C (cold) ¹⁾	M _{max 20°C}	Nm	17.3	
Maximum torque 100K (warm) ¹⁾	M _{max 100K}	Nm	16.0	
Maximum current	I _{max(rms)}	A	12.75	
Maximum speed (electrical)	n _{max el}	1/min	6000	
Maximum speed (mechanical)	n _{max mech}	1/min	6000	
Number of pole pairs	p		5	
Torque constant at 20 °C ¹⁾	K _m	Nm/A	1.73	
Voltage constant at 20 °C ¹⁾	K _E	V/1000 min ⁻¹	105.4	
Winding resistance at 20 °C	R ₁₂	Ohm	4.48	
Winding inductance	L _{12,min}	mH	39.5	
Leakage capacitance of the component	C _{ab}	nF	1.24	
Thermal time constant of winding	T _{th,W}	s	27.3	
Thermal time constant of motor	T _{th,M}	min	14.1	
Mass	m _{mot}	kg	6.4	7.4
Holding brake				
Holding torque	M ₄	Nm	0	10.00
Rated voltage	U _N	V	0	24
Rated current	I _N	A	0	0.73
Maximum connection time	t ₁	ms	0	30
Maximum disconnection time	t ₂	ms	0	80
1) For tolerance details refer to chapter 6.4 Tolerances			Latest amendment: 2016-07-13	

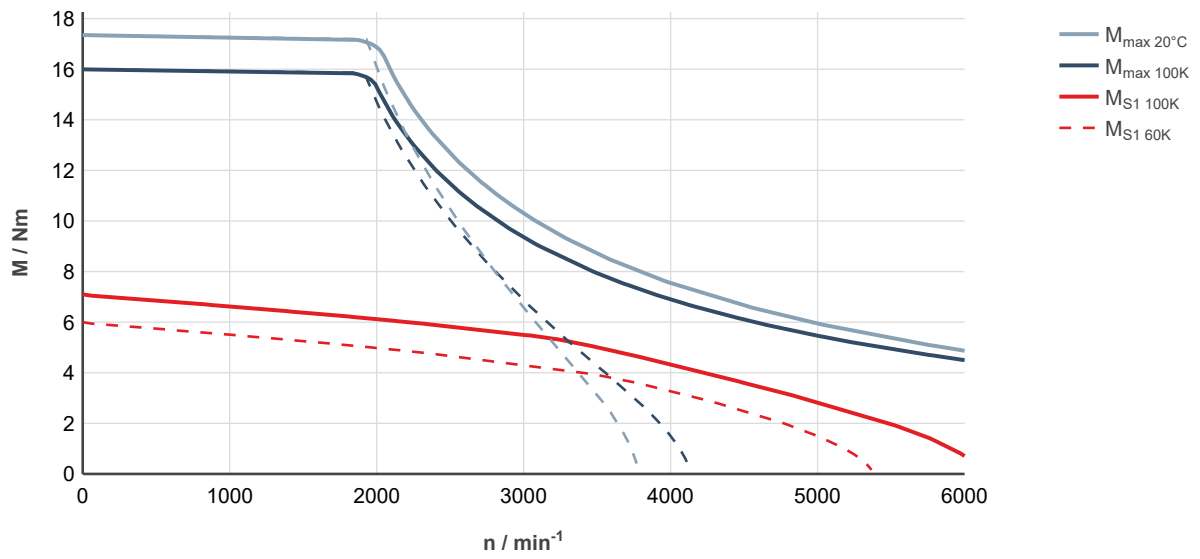

Fig. 70: MS2N06-C0BNN-___0-___-_, ctrlX DRIVE, uncontrolled supply 3 × AC 400 V

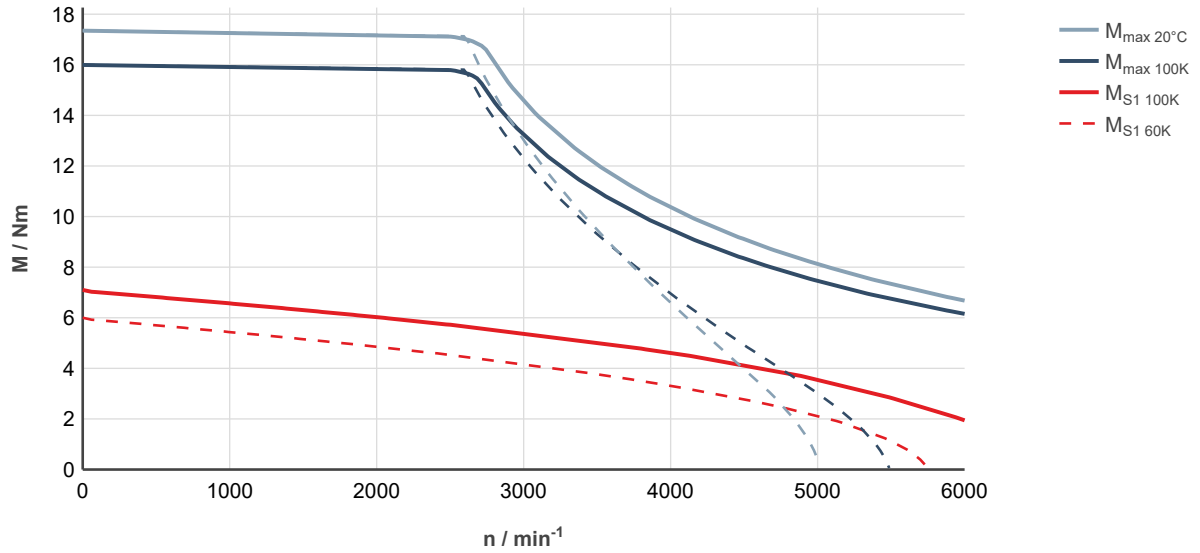

Fig. 71: MS2N06-C0BNN-___0-___-_, ctrlX DRIVE, controlled supply 3 × AC 400 ... 480 V

MS2N06-C0BTN

Designation	Symbol	Unit	MS2N06-C0BTN-__0-_N	MS2N06-C0BTN-__1-_N
Standstill torque - 60K ¹⁾	M _{0 60K}	Nm	6.0	
Standstill current - 60K	I _{0 60K}	A	7.5	
Standstill torque - 100K ¹⁾	M _{0 100K}	Nm	7.1	
Standstill current - 100K	I _{0 100K}	A	9.0	
Moment of inertia of rotor ¹⁾	J _{rot}	kg*m ²	0.00039	0.00050
Rated speed - 100K	n _{N 100K}	1/min	4020	
Rated torque - 100K ¹⁾	M _{N 100K}	Nm	3.35	
Rated current - 100K	I _{N 100K}	A	4.52	
Rated power - 100K ¹⁾	P _{N 100K}	kW	1.41	
Maximum torque 20 °C (cold) ¹⁾	M _{max 20°C}	Nm	17.3	
Maximum torque 100K (warm) ¹⁾	M _{max 100K}	Nm	16.0	
Maximum current	I _{max(rms)}	A	25.5	
Maximum speed (electrical)	n _{max el}	1/min	6000	
Maximum speed (mechanical)	n _{max mech}	1/min	6000	
Number of pole pairs	p		5	
Torque constant at 20 °C ¹⁾	K _m	Nm/A	0.87	
Voltage constant at 20 °C ¹⁾	K _E	V/1000 min ⁻¹	52.7	
Winding resistance at 20 °C	R ₁₂	Ohm	1.12	
Winding inductance	L _{12,min}	mH	9.17	
Leakage capacitance of the component	C _{ab}	nF	1.2	
Thermal time constant of winding	T _{th,W}	s	27.3	
Thermal time constant of motor	T _{th,M}	min	14.1	
Mass	m _{mot}	kg	6.4	7.4
Holding brake				
Holding torque	M ₄	Nm	0	10.00
Rated voltage	U _N	V	0	24
Rated current	I _N	A	0	0.73
Maximum connection time	t ₁	ms	0	30
Maximum disconnection time	t ₂	ms	0	80
1) For tolerance details refer to chapter 6.4 Tolerances			Latest amendment: 2016-07-13	

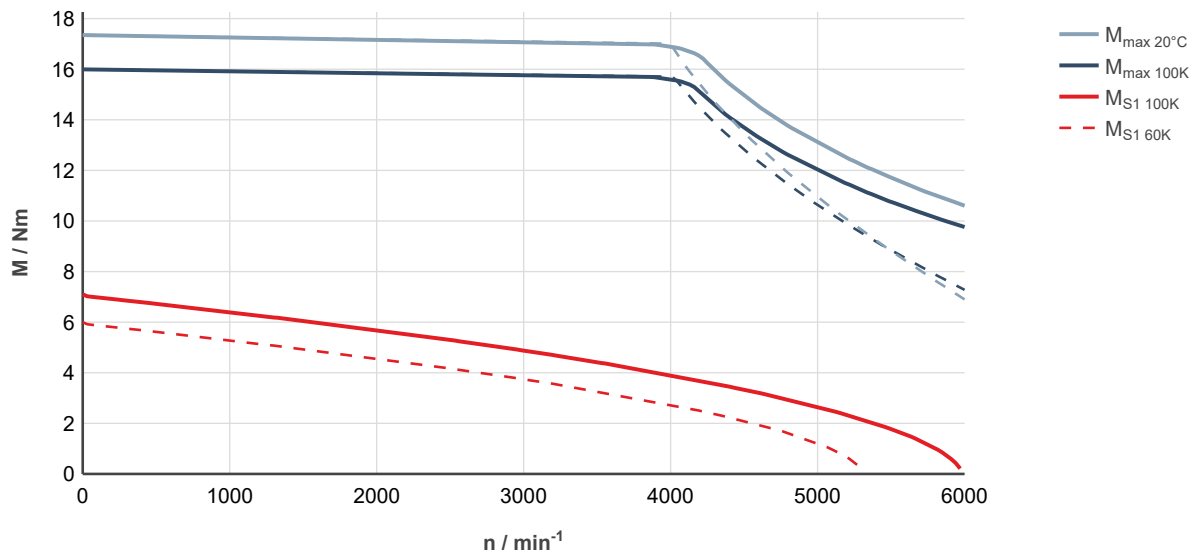

Fig. 72: MS2N06-C0BTN-___0-___-__, ctrlX DRIVE, uncontrolled supply 3 × AC 400 V

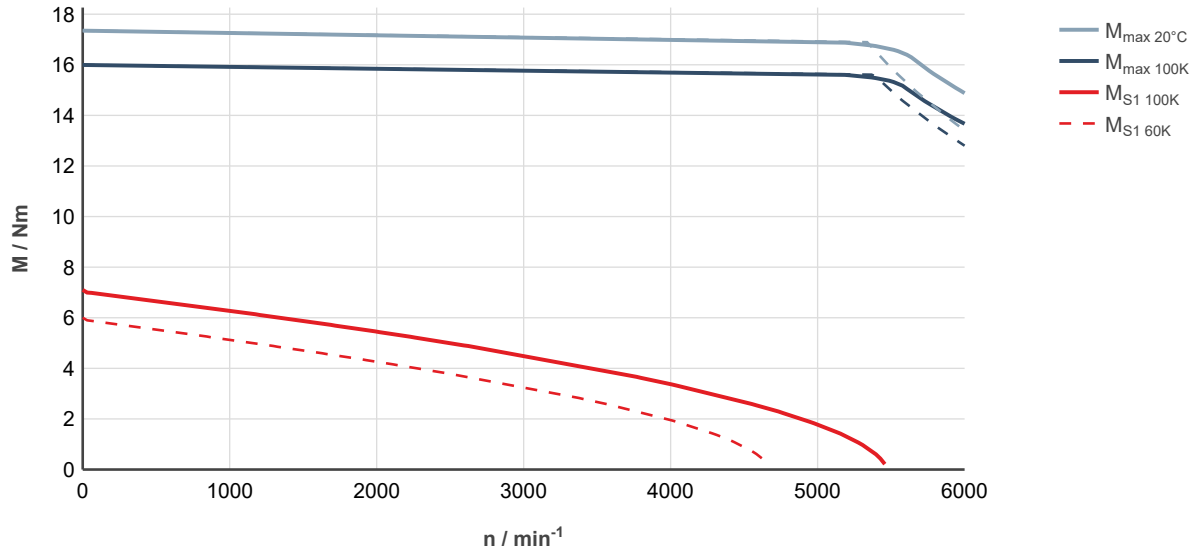

Fig. 73: MS2N06-C0BTN-___0-___-__, ctrlX DRIVE, controlled supply 3 × AC 400 ... 480 V

MS2N06-D0BNN

Designation	Symbol	Unit	MS2N06-D0BNN-__0-_N	MS2N06-D0BNN-__2-_N
Standstill torque - 60K ¹⁾	M _{0 60K}	Nm	9.7	
Standstill current - 60K	I _{0 60K}	A	6.1	
Standstill torque - 100K ¹⁾	M _{0 100K}	Nm	11.9	
Standstill current - 100K	I _{0 100K}	A	7.55	
Moment of inertia of rotor ¹⁾	J _{rot}	kg*m ²	0.00065	0.00079
Rated speed - 100K	n _{N 100K}	1/min	2960	
Rated torque - 100K ¹⁾	M _{N 100K}	Nm	8.5	
Rated current - 100K	I _{N 100K}	A	5.6	
Rated power - 100K ¹⁾	P _{N 100K}	kW	2.63	
Maximum torque 20 °C (cold) ¹⁾	M _{max 20°C}	Nm	34.8	
Maximum torque 100K (warm) ¹⁾	M _{max 100K}	Nm	32.0	
Maximum current	I _{max(rms)}	A	25.4	
Maximum speed (electrical)	n _{max el}	1/min	6000	
Maximum speed (mechanical)	n _{max mech}	1/min	6000	
Number of pole pairs	p		5	
Torque constant at 20 °C ¹⁾	K _m	Nm/A	1.70	
Voltage constant at 20 °C ¹⁾	K _E	V/1000 min ⁻¹	103.5	
Winding resistance at 20 °C	R ₁₂	Ohm	1.85	
Winding inductance	L _{12,min}	mH	18	
Leakage capacitance of the component	C _{ab}	nF	5	
Thermal time constant of winding	T _{th,W}	s	38.6	
Thermal time constant of motor	T _{th,M}	min	17.4	
Mass	m _{mot}	kg	9.0	10.5
Holding brake				
Holding torque	M ₄	Nm	0	15.00
Rated voltage	U _N	V	0	24
Rated current	I _N	A	0	0.75
Maximum connection time	t ₁	ms	0	50
Maximum disconnection time	t ₂	ms	0	135

1) For tolerance details refer to [chapter 6.4 Tolerances](#) Latest amendment: 2016-07-13

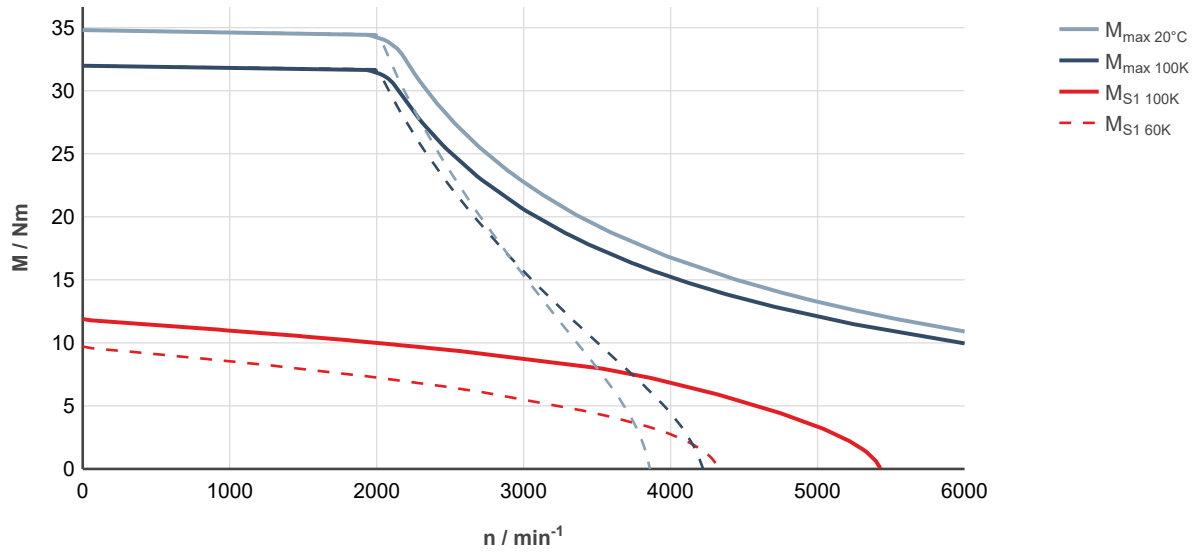

Fig. 74: MS2N06-D0BNN-___0-___-_, ctrlX DRIVE, uncontrolled supply 3 × AC 400 V

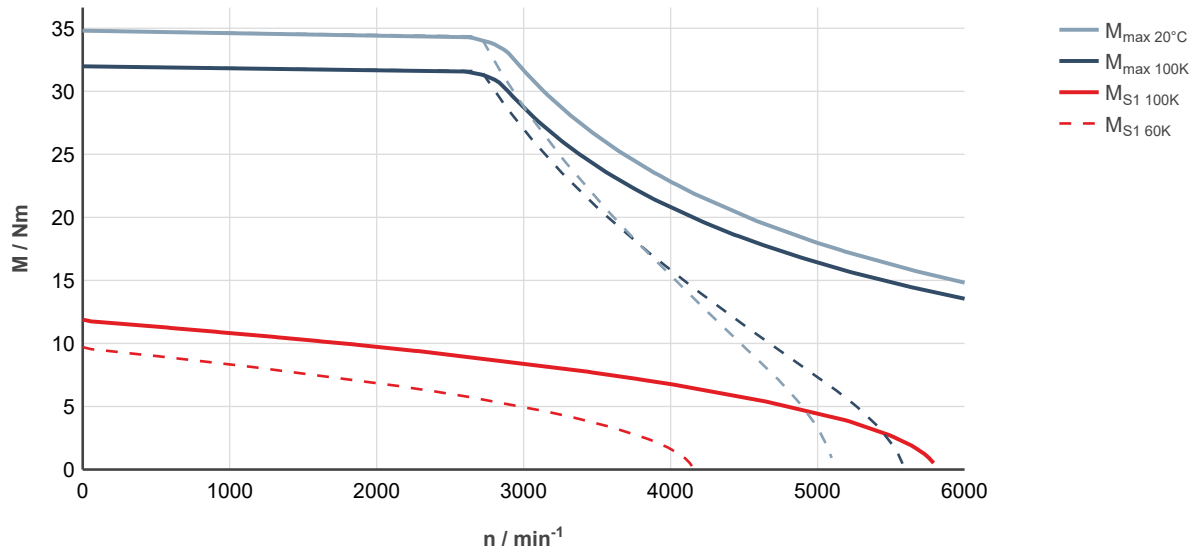

Fig. 75: MS2N06-D0BNN-___0-___-_, ctrlX DRIVE, controlled supply 3 × AC 400 ... 480 V

MS2N06-D0BRN

Designation	Symbol	Unit	MS2N06-D0BRN-__0-_N	MS2N06-D0BRN-__2-_N
Standstill torque - 60K ¹⁾	M _{0 60K}	Nm	9.70	
Standstill current - 60K	I _{0 60K}	A	7.85	
Standstill torque - 100K ¹⁾	M _{0 100K}	Nm	11.9	
Standstill current - 100K	I _{0 100K}	A	9.75	
Moment of inertia of rotor ¹⁾	J _{rot}	kg*m ²	0.00065	0.00079
Rated speed - 100K	n _{N 100K}	1/min	3800	
Rated torque - 100K ¹⁾	M _{N 100K}	Nm	6.20	
Rated current - 100K	I _{N 100K}	A	5.40	
Rated power - 100K ¹⁾	P _{N 100K}	kW	2.48	
Maximum torque 20 °C (cold) ¹⁾	M _{max 20°C}	Nm	34.8	
Maximum torque 100K (warm) ¹⁾	M _{max 100K}	Nm	32.0	
Maximum current	I _{max(rms)}	A	32.7	
Maximum speed (electrical)	n _{max el}	1/min	6000	
Maximum speed (mechanical)	n _{max mech}	1/min	6000	
Number of pole pairs	p		5	
Torque constant at 20 °C ¹⁾	K _m	Nm/A	1.33	
Voltage constant at 20 °C ¹⁾	K _E	V/1000 min ⁻¹	80.5	
Winding resistance at 20 °C	R ₁₂	Ohm	1.13	
Winding inductance	L _{12_min}	mH	11.06	
Leakage capacitance of the component	C _{ab}	nF	2.55	
Thermal time constant of winding	T _{th_W}	s	38.6	
Thermal time constant of motor	T _{th_M}	min	17.4	
Mass	m _{mot}	kg	9.0	10.5
Holding brake				
Holding torque	M ₄	Nm	0	15.00
Rated voltage	U _N	V	0	24
Rated current	I _N	A	0	0.75
Maximum connection time	t ₁	ms	0	50
Maximum disconnection time	t ₂	ms	0	135

1) For tolerance details refer to [chapter 6.4 Tolerances](#) Latest amendment: 2016-07-13

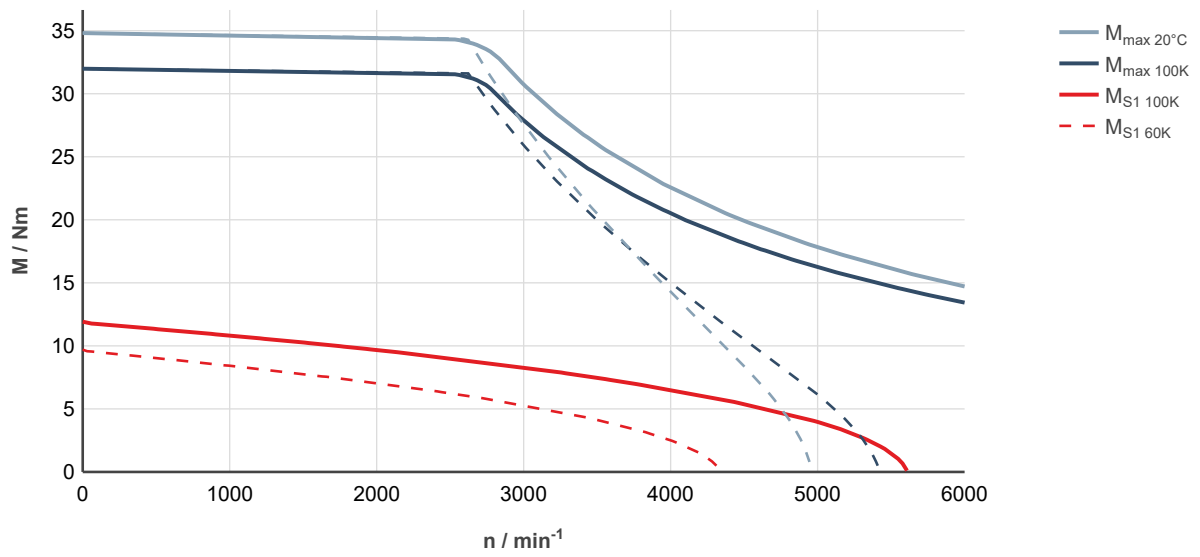

Fig. 76: MS2N06-D0BRN-___0-___-__, ctrlX DRIVE, uncontrolled supply 3 × AC 400 V

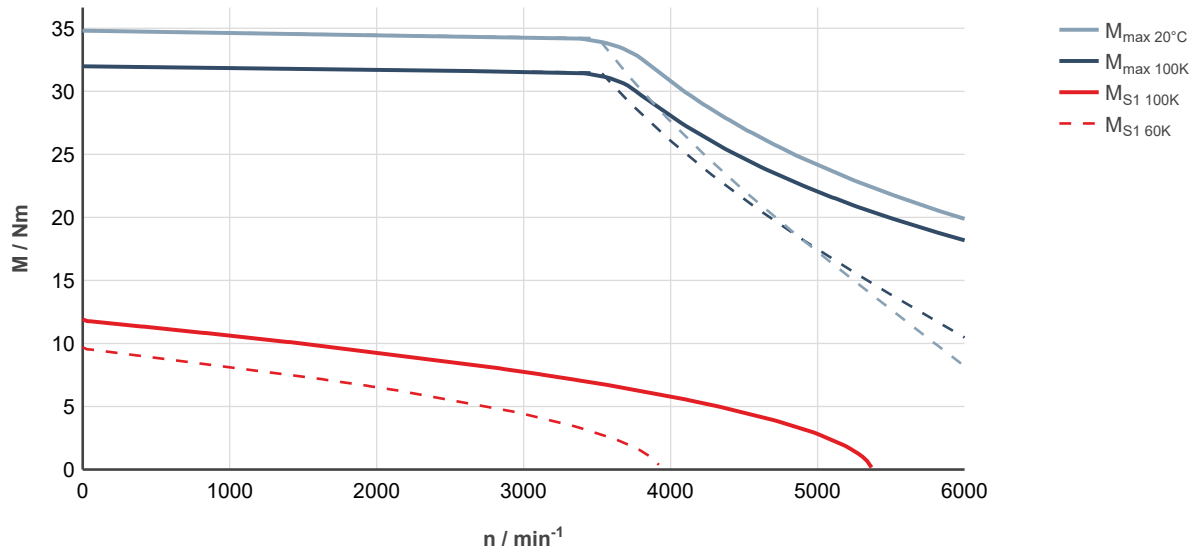

Fig. 77: MS2N06-D0BRN-___0-___-__, ctrlX DRIVE, controlled supply 3 × AC 400 ... 480 V

MS2N06-D1BNN

Designation	Symbol	Unit	MS2N06-D1BNN-__0-_N	MS2N06-D1BNN-__2-_N
Standstill torque - 60K ¹⁾	M _{0 60K}	Nm	9.0	
Standstill current - 60K	I _{0 60K}	A	5.05	
Standstill torque - 100K ¹⁾	M _{0 100K}	Nm	11.1	
Standstill current - 100K	I _{0 100K}	A	6.25	
Moment of inertia of rotor ¹⁾	J _{rot}	kg*m ²	0.0014	0.00154
Rated speed - 100K	n _{N 100K}	1/min	3000	
Rated torque - 100K ¹⁾	M _{N 100K}	Nm	6.40	
Rated current - 100K	I _{N 100K}	A	3.82	
Rated power - 100K ¹⁾	P _{N 100K}	kW	2.01	
Maximum torque 20 °C (cold) ¹⁾	M _{max 20°C}	Nm	41.8	
Maximum torque 100K (warm) ¹⁾	M _{max 100K}	Nm	38.4	
Maximum current	I _{max(rms)}	A	25.5	
Maximum speed (electrical)	n _{max el}	1/min	6000	
Maximum speed (mechanical)	n _{max mech}	1/min	6000	
Number of pole pairs	p		5	
Torque constant at 20 °C ¹⁾	K _m	Nm/A	1.93	
Voltage constant at 20 °C ¹⁾	K _E	V/1000 min ⁻¹	117.3	
Winding resistance at 20 °C	R ₁₂	Ohm	2.75	
Winding inductance	L _{12,min}	mH	18.0	
Leakage capacitance of the component	C _{ab}	nF	1.84	
Thermal time constant of winding	T _{th,W}	s	32.5	
Thermal time constant of motor	T _{th,M}	min	17.4	
Mass	m _{mot}	kg	9.0	10.5
Holding brake				
Holding torque	M ₄	Nm	0	15.00
Rated voltage	U _N	V	0	24
Rated current	I _N	A	0	0.75
Maximum connection time	t ₁	ms	0	50
Maximum disconnection time	t ₂	ms	0	135

1) For tolerance details refer to [chapter 6.4 Tolerances](#) Latest amendment: 2017-08-09

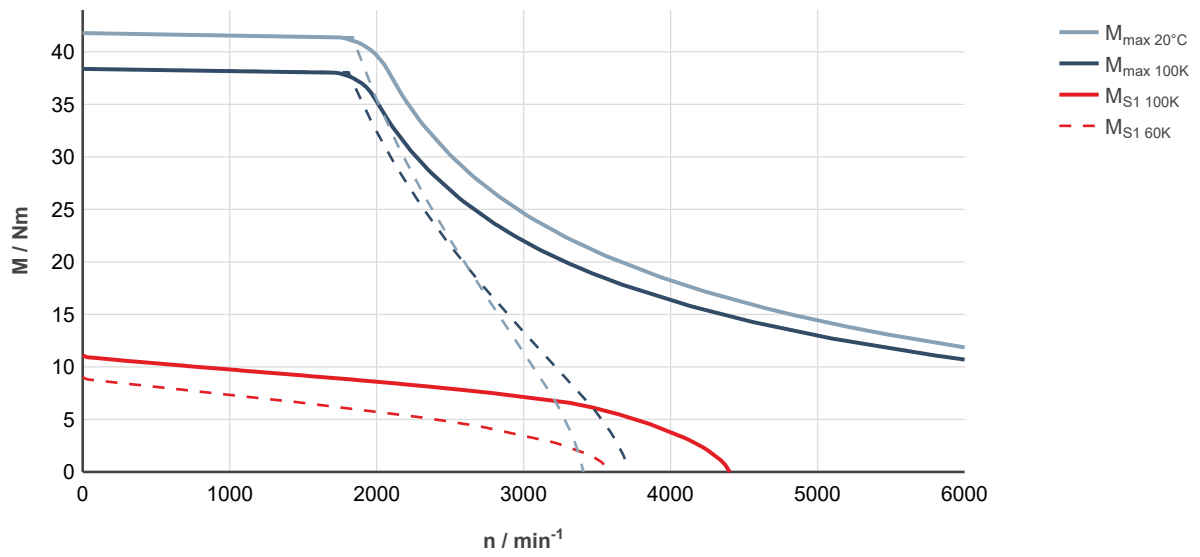

Fig. 78: MS2N06-D1BNN-___0-___-_, ctrlX DRIVE, uncontrolled supply 3 × AC 400 V

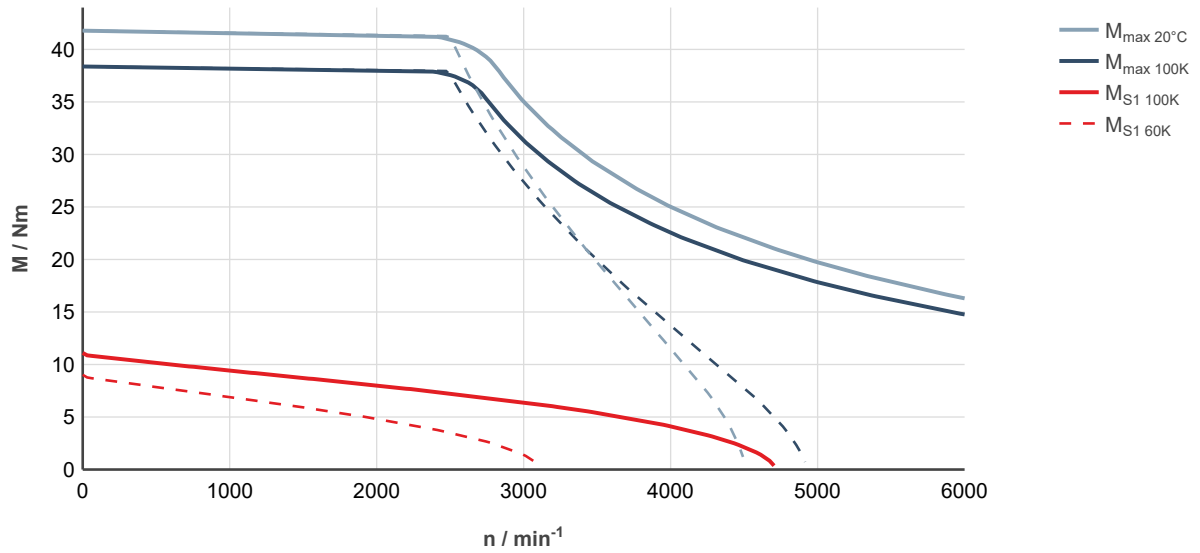

Fig. 79: MS2N06-D1BNN-___0-___-_, ctrlX DRIVE, controlled supply 3 × AC 400 ... 480 V

MS2N06-E0BHN

Designation	Symbol	Unit	MS2N06-E0BHN-__0-_N	MS2N06-E0BHN-__2-_N
Standstill torque - 60K ¹⁾	M _{0 60K}	Nm	13.0	
Standstill current - 60K	I _{0 60K}	A	5.4	
Standstill torque - 100K ¹⁾	M _{0 100K}	Nm	16.3	
Standstill current - 100K	I _{0 100K}	A	6.8	
Moment of inertia of rotor ¹⁾	J _{rot}	kg*m ²	0.00089	0.00103
Rated speed - 100K	n _{N 100K}	1/min	2000	
Rated torque - 100K ¹⁾	M _{N 100K}	Nm	13.15	
Rated current - 100K	I _{N 100K}	A	5.65	
Rated power - 100K ¹⁾	P _{N 100K}	kW	2.75	
Maximum torque 20 °C (cold) ¹⁾	M _{max 20°C}	Nm	53.4	
Maximum torque 100K (warm) ¹⁾	M _{max 100K}	Nm	49.0	
Maximum current	I _{max(rms)}	A	25.4	
Maximum speed (electrical)	n _{max el}	1/min	4000	
Maximum speed (mechanical)	n _{max mech}	1/min	6000	
Number of pole pairs	p		5	
Torque constant at 20 °C ¹⁾	K _m	Nm/A	2.58	
Voltage constant at 20 °C ¹⁾	K _E	V/1000 min ⁻¹	157	
Winding resistance at 20 °C	R ₁₂	Ohm	2.54	
Winding inductance	L _{12,min}	mH	27.6	
Leakage capacitance of the component	C _{ab}	nF	3.03	
Thermal time constant of winding	T _{th,W}	s	48.6	
Thermal time constant of motor	T _{th,M}	min	20.0	
Mass	m _{mot}	kg	11.5	13.0
Holding brake				
Holding torque	M ₄	Nm	0	15.00
Rated voltage	U _N	V	0	24
Rated current	I _N	A	0	0.75
Maximum connection time	t ₁	ms	0	50
Maximum disconnection time	t ₂	ms	0	135

1) For tolerance details refer to [chapter 6.4 Tolerances](#) Latest amendment: 2016-07-13

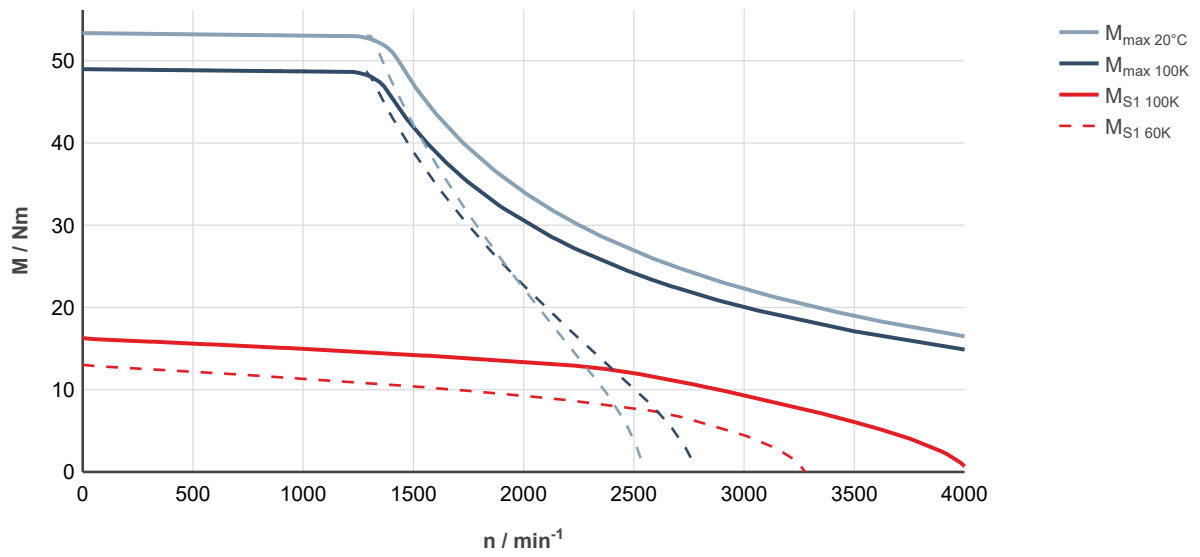

Fig. 80: MS2N06-E0BHN-___0-___-__, ctrlX DRIVE, uncontrolled supply 3 × AC 400 V

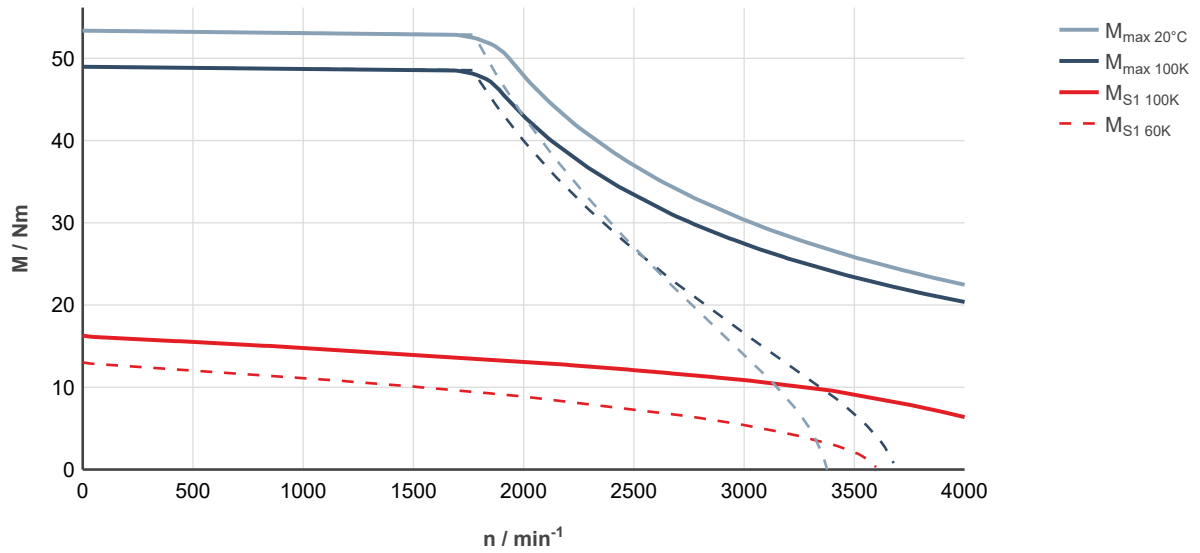

Fig. 81: MS2N06-E0BHN-___0-___-__, ctrlX DRIVE, controlled supply 3 × AC 400 ... 480 V

MS2N06-E0BRN

Designation	Symbol	Unit	MS2N06-E0BRN-__0-_N	MS2N06-E0BRN-__2-_N
Standstill torque - 60K ¹⁾	M _{0 60K}	Nm	13.0	
Standstill current - 60K	I _{0 60K}	A	10.85	
Standstill torque - 100K ¹⁾	M _{0 100K}	Nm	16.3	
Standstill current - 100K	I _{0 100K}	A	13.7	
Moment of inertia of rotor ¹⁾	J _{rot}	kg*m ²	0.00089	0.00103
Rated speed - 100K	n _{N 100K}	1/min	3120	
Rated torque - 100K ¹⁾	M _{N 100K}	Nm	8.05	
Rated current - 100K	I _{N 100K}	A	7.2	
Rated power - 100K ¹⁾	P _{N 100K}	kW	2.63	
Maximum torque 20 °C (cold) ¹⁾	M _{max 20°C}	Nm	53.4	
Maximum torque 100K (warm) ¹⁾	M _{max 100K}	Nm	49.0	
Maximum current	I _{max(rms)}	A	50.8	
Maximum speed (electrical)	n _{max el}	1/min	6000	
Maximum speed (mechanical)	n _{max mech}	1/min	6000	
Number of pole pairs	p		5	
Torque constant at 20 °C ¹⁾	K _m	Nm/A	1.29	
Voltage constant at 20 °C ¹⁾	K _E	V/1000 min ⁻¹	78.4	
Winding resistance at 20 °C	R ₁₂	Ohm	0.638	
Winding inductance	L _{12,min}	mH	6.895	
Leakage capacitance of the component	C _{ab}	nF	3.87	
Thermal time constant of winding	T _{th,W}	s	48.6	
Thermal time constant of motor	T _{th,M}	min	20.0	
Mass	m _{mot}	kg	11.5	13.0
Holding brake				
Holding torque	M ₄	Nm	0	15.00
Rated voltage	U _N	V	0	24
Rated current	I _N	A	0	0.75
Maximum connection time	t ₁	ms	0	50
Maximum disconnection time	t ₂	ms	0	135

1) For tolerance details refer to [chapter 6.4 Tolerances](#) Latest amendment: 2016-11-08

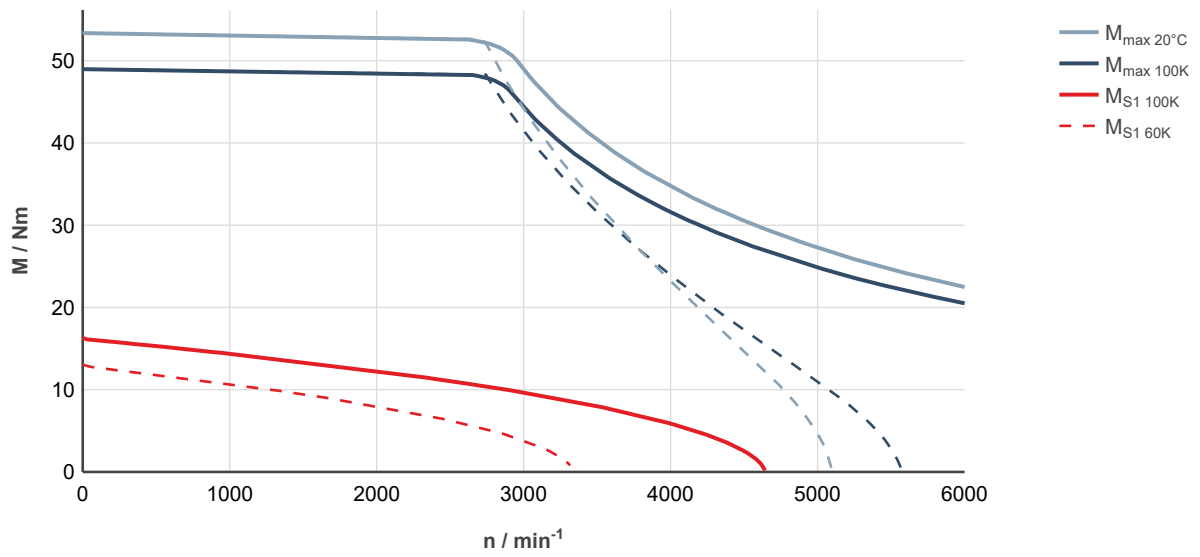

Fig. 82: MS2N06-E0BRN-___0-___-__, ctrlX DRIVE, uncontrolled supply 3 × AC 400 V

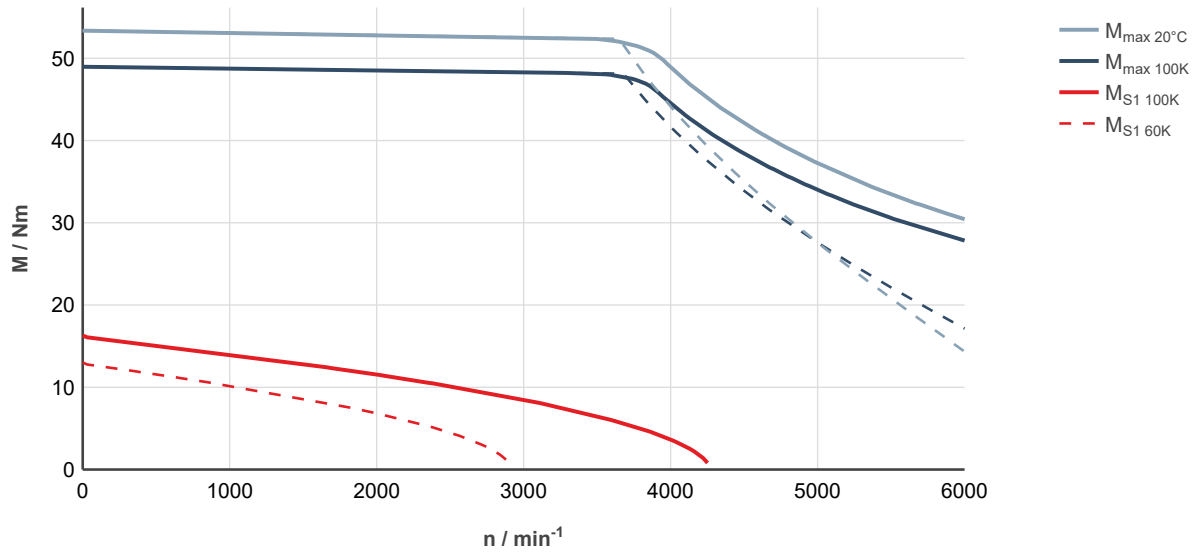
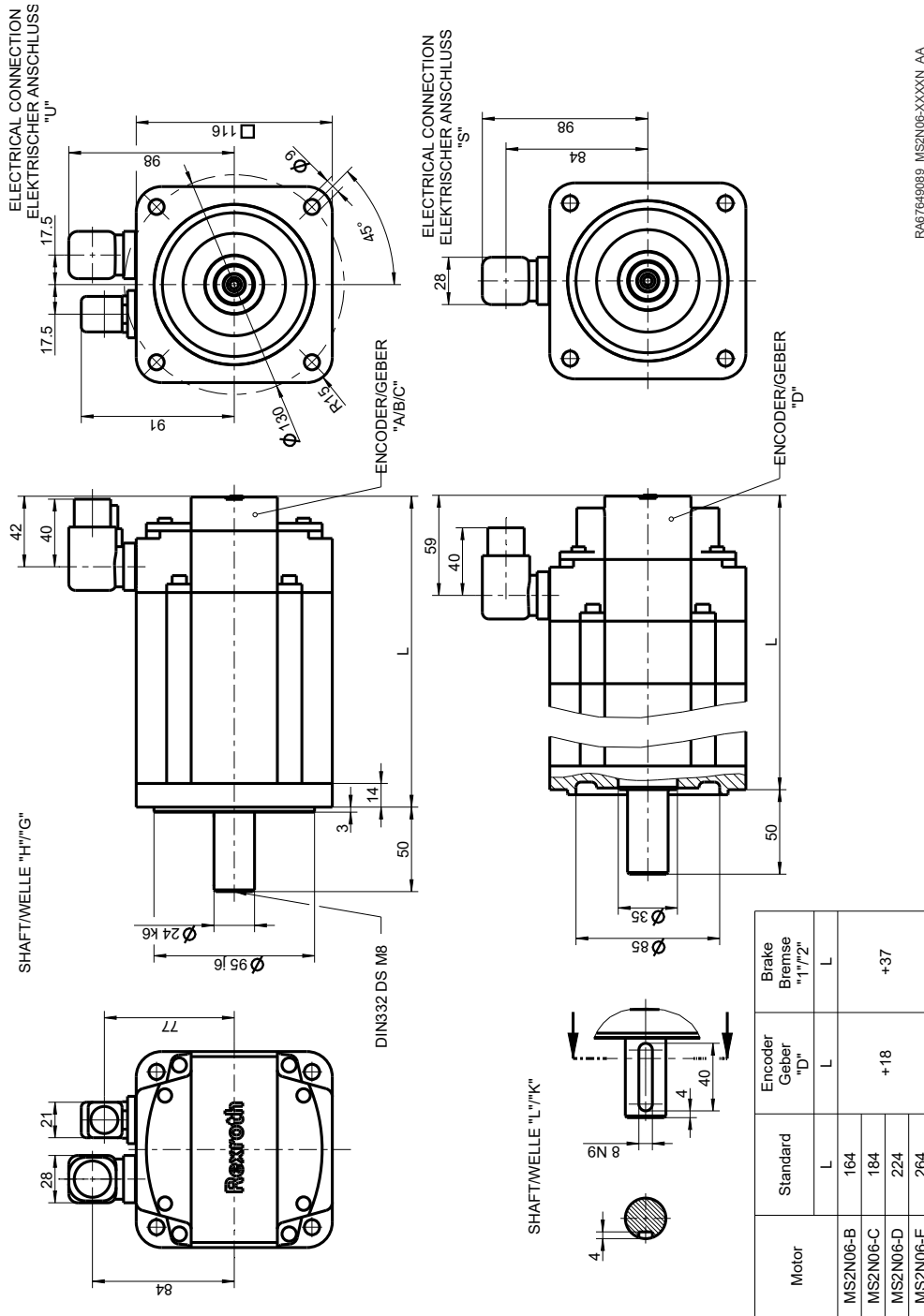

Fig. 83: MS2N06-E0BRN-___0-___-__, ctrlX DRIVE, controlled supply 3 × AC 400 ... 480 V

7.4.2 MS2N06 Self-cooling specification



RA67649089_MS2N06-XXXXN_AA

Fig. 84: MS2N06-XXXXN

7.4.3 MS2N06 Axial force

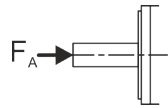

Axial forces F_A are permissible without limitation up to 40 N. Higher axial forces only after a detailed dimensioning by your distribution partner at Bosch Rexroth. For evaluation purposes, please specify the following information:

- Axial and radial force with force application point
- Installation position (horizontal, vertical with the shaft end pointing to the top or bottom)
- Mean speed

7.4.4 MS2N06 Radial force

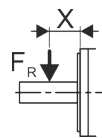

The permissible radial force F_R is specified in distance x from the shaft shoulder, depending on the mean speed in the following diagram.

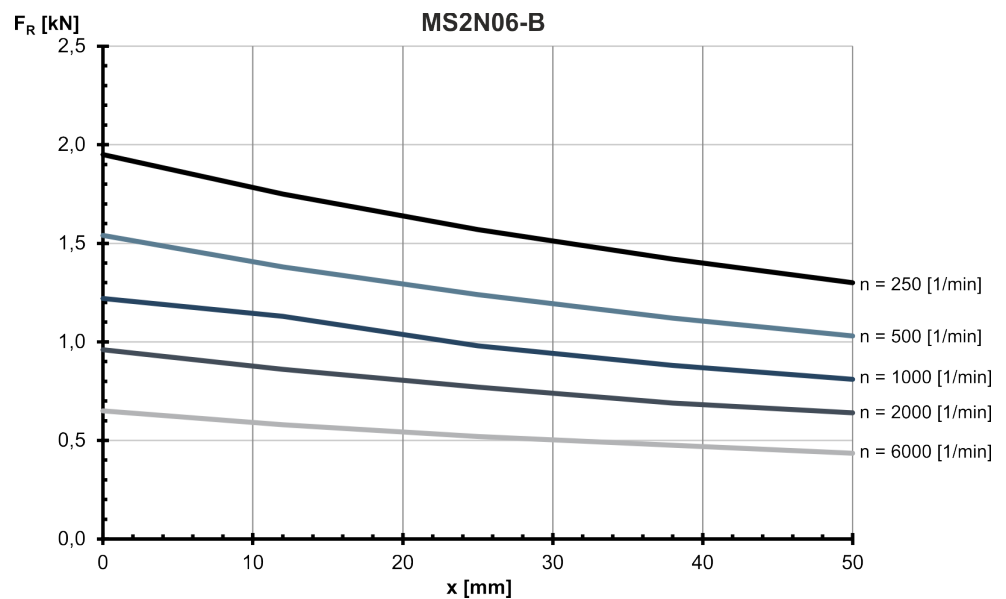

Fig. 85: MS2N06-B: Radial force in distance x from the shaft shoulder at a nominal bearing service life of $L_{h10} = 30000$ h

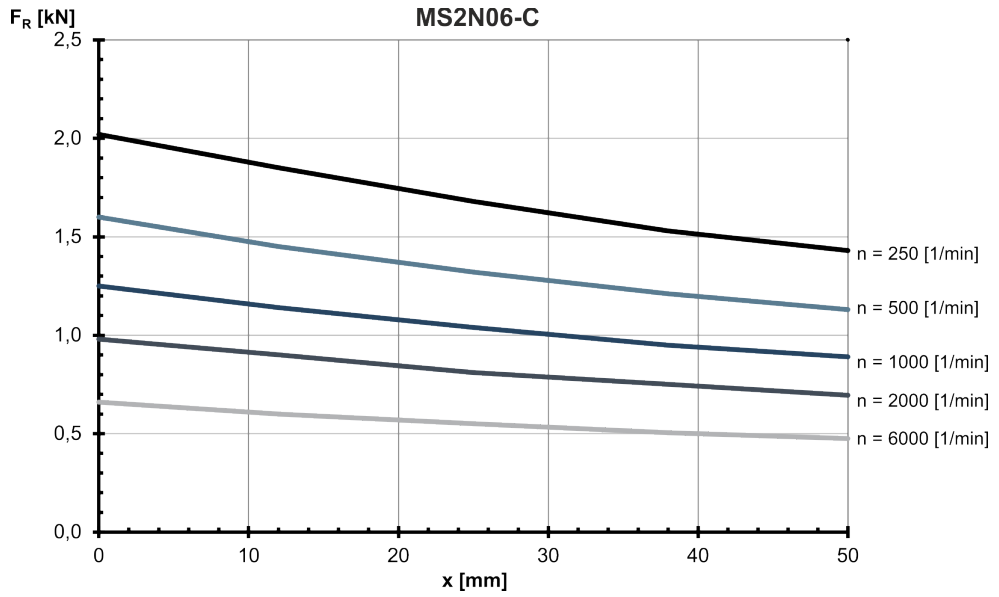

Fig. 86: MS2N06-C: Radial force in distance x from the shaft shoulder at a nominal bearing service life of $L_{h10} = 30000$ h

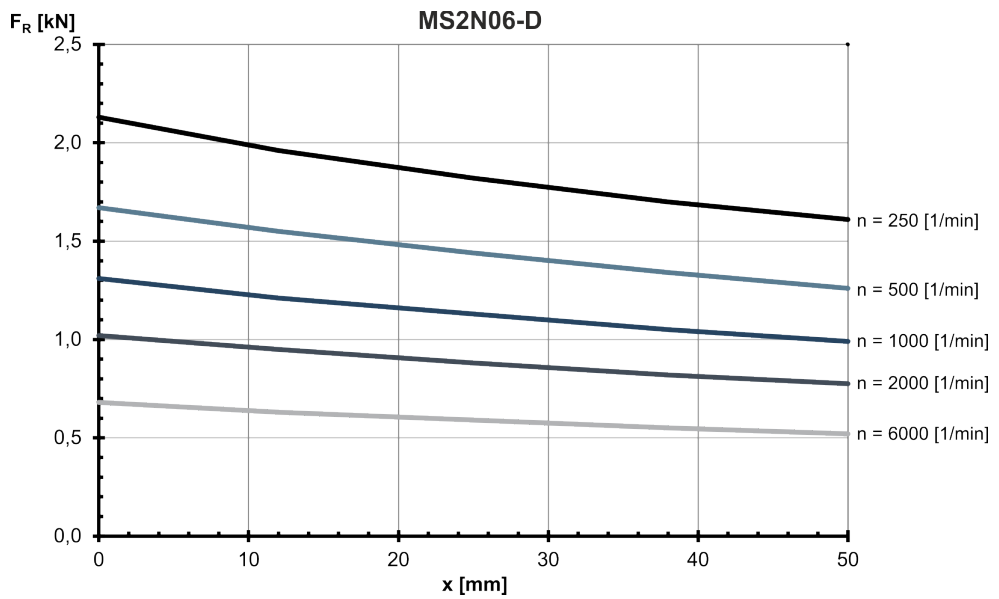

Fig. 87: MS2N06-D: Radial force in distance x from the shaft shoulder at a nominal bearing service life of $L_{h10} = 30000$ h

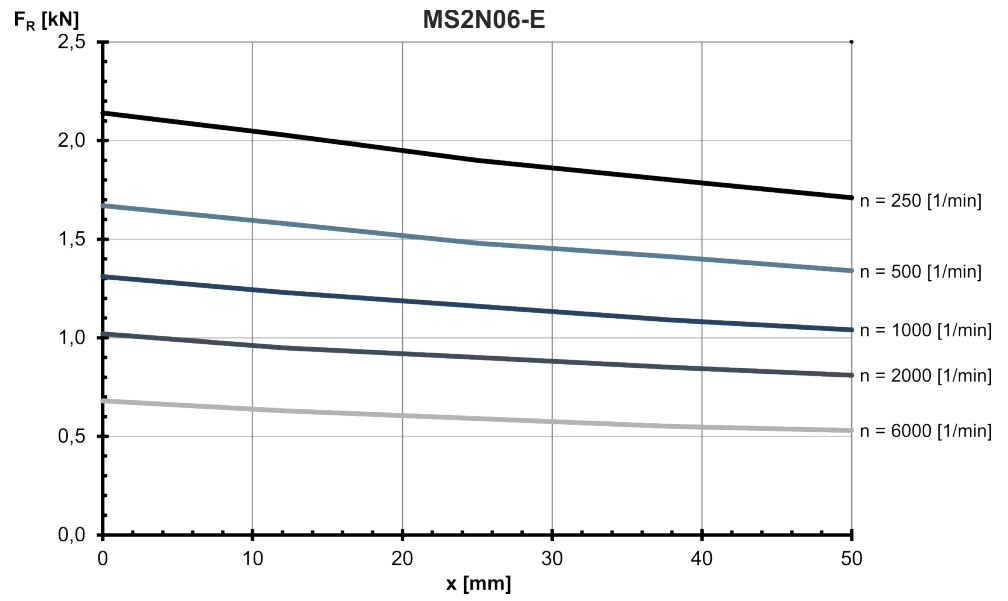

Fig. 88: MS2N06-E: Radial force in distance x from the shaft shoulder at a nominal bearing service life of $L_{h10} = 30000$ h

7.5 MS2N07 Technical data

7.5.1 Self-cooling

MS2N07-B1BNN

Designation	Symbol	Unit	MS2N07-B1BNN-__0-_N	MS2N07-B1BNN-__1-_N
Standstill torque - 60K ¹⁾	M _{0 60K}	Nm	7.4	
Standstill current - 60K	I _{0 60K}	A	4.25	
Standstill torque - 100K ¹⁾	M _{0 100K}	Nm	8.2	
Standstill current - 100K	I _{0 100K}	A	4.74	
Moment of inertia of rotor ¹⁾	J _{rot}	kg*m ²	0.00197	0.00223
Rated speed - 100K	n _{N 100K}	1/min	2920	
Rated torque - 100K ¹⁾	M _{N 100K}	Nm	6.8	
Rated current - 100K	I _{N 100K}	A	4.04	
Rated power - 100K ¹⁾	P _{N 100K}	kW	2.08	
Maximum torque 20 °C (cold) ¹⁾	M _{max 20°C}	Nm	22.8	
Maximum torque 100K (warm) ¹⁾	M _{max 100K}	Nm	21.0	
Maximum current	I _{max(rms)}	A	14.8	
Maximum speed (electrical)	n _{max el}	1/min	6000	
Maximum speed (mechanical)	n _{max mech}	1/min	6000	
Number of pole pairs	p		5	
Torque constant at 20 °C ¹⁾	K _m	Nm/A	1.89	
Voltage constant at 20 °C ¹⁾	K _E	V/1000 min ⁻¹	115.1	
Winding resistance at 20 °C	R ₁₂	Ohm	4.62	
Winding inductance	L _{12,min}	mH	31.29	
Leakage capacitance of the component	C _{ab}	nF	0.9	
Thermal time constant of winding	T _{th,W}	s	34.9	
Thermal time constant of motor	T _{th,M}	min	13.0	
Mass	m _{mot}	kg	9.5	11.5
Holding brake				
Holding torque	M ₄	Nm	0	20.00
Rated voltage	U _N	V	0	24
Rated current	I _N	A	0	0.78
Maximum connection time	t ₁	ms	0	40
Maximum disconnection time	t ₂	ms	0	100
1) For tolerance details refer to chapter 6.4 Tolerances			Latest amendment: 2017-08-09	

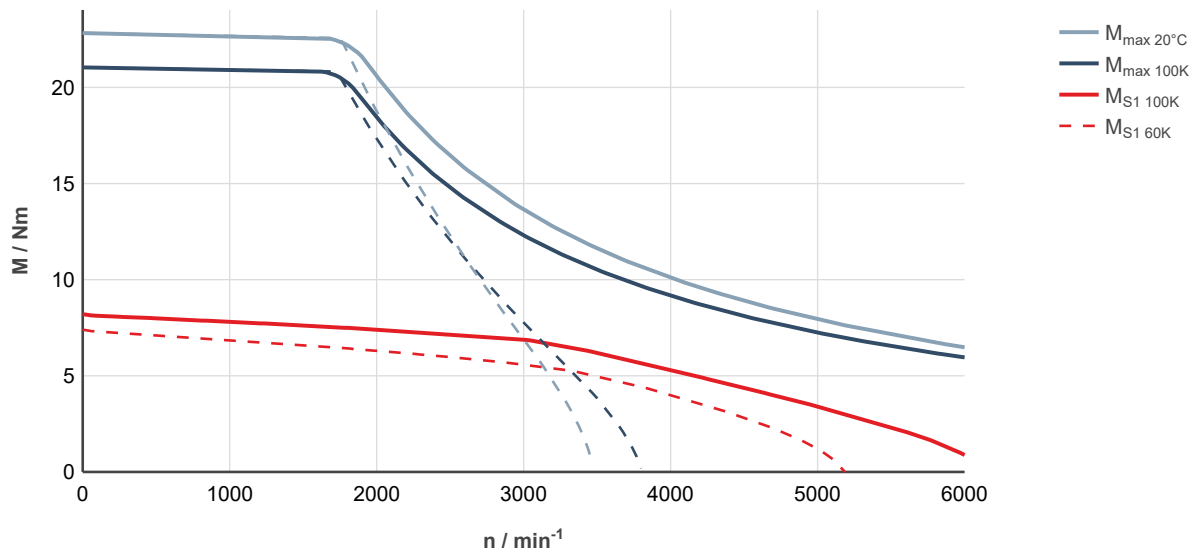

Fig. 89: MS2N07-B1BNN-___0-___-__, ctrlX DRIVE, uncontrolled supply 3 × AC 400 V

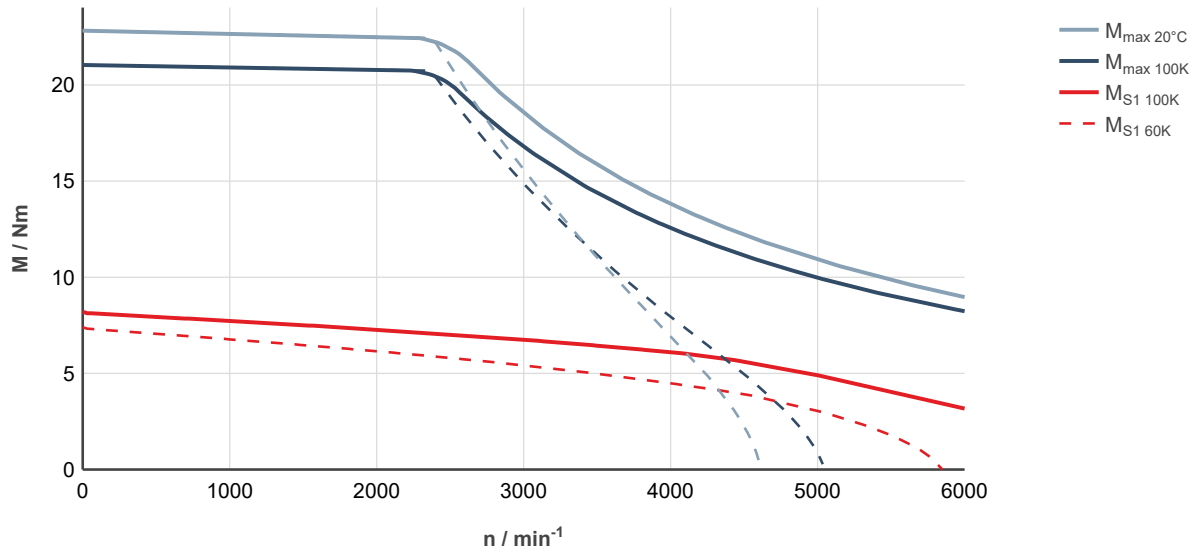

Fig. 90: MS2N07-B1BNN-___0-___-__, ctrlX DRIVE, controlled supply 3 × AC 400 ... 480 V

MS2N07-C0BNN

Designation	Symbol	Unit	MS2N07-C0BNN-__0-_N	MS2N07-C0BNN-__1-_N
Standstill torque - 60K ¹⁾	M _{0 60K}	Nm	12.8	
Standstill current - 60K	I _{0 60K}	A	6.9	
Standstill torque - 100K ¹⁾	M _{0 100K}	Nm	16.0	
Standstill current - 100K	I _{0 100K}	A	8.8	
Moment of inertia of rotor ¹⁾	J _{rot}	kg*m ²	0.0012	0.00146
Rated speed - 100K	n _{N 100K}	1/min	2650	
Rated torque - 100K ¹⁾	M _{N 100K}	Nm	12.65	
Rated current - 100K	I _{N 100K}	A	7.05	
Rated power - 100K ¹⁾	P _{N 100K}	kW	3.5	
Maximum torque 20 °C (cold) ¹⁾	M _{max 20°C}	Nm	38.8	
Maximum torque 100K (warm) ¹⁾	M _{max 100K}	Nm	35.7	
Maximum current	I _{max(rms)}	A	24.8	
Maximum speed (electrical)	n _{max el}	1/min	6000	
Maximum speed (mechanical)	n _{max mech}	1/min	6000	
Number of pole pairs	p		5	
Torque constant at 20 °C ¹⁾	K _m	Nm/A	2.01	
Voltage constant at 20 °C ¹⁾	K _E	V/1000 min ⁻¹	122.0	
Winding resistance at 20 °C	R ₁₂	Ohm	1.58	
Winding inductance	L _{12,min}	mH	23.2	
Leakage capacitance of the component	C _{ab}	nF	2.42	
Thermal time constant of winding	T _{th,W}	s	46.4	
Thermal time constant of motor	T _{th,M}	min	14.8	
Mass	m _{mot}	kg	12.0	14.0
Holding brake				
Holding torque	M ₄	Nm	0	20.00
Rated voltage	U _N	V	0	24
Rated current	I _N	A	0	0.78
Maximum connection time	t ₁	ms	0	40
Maximum disconnection time	t ₂	ms	0	100
1) For tolerance details refer to chapter 6.4 Tolerances			Latest amendment: 2017-03-02	

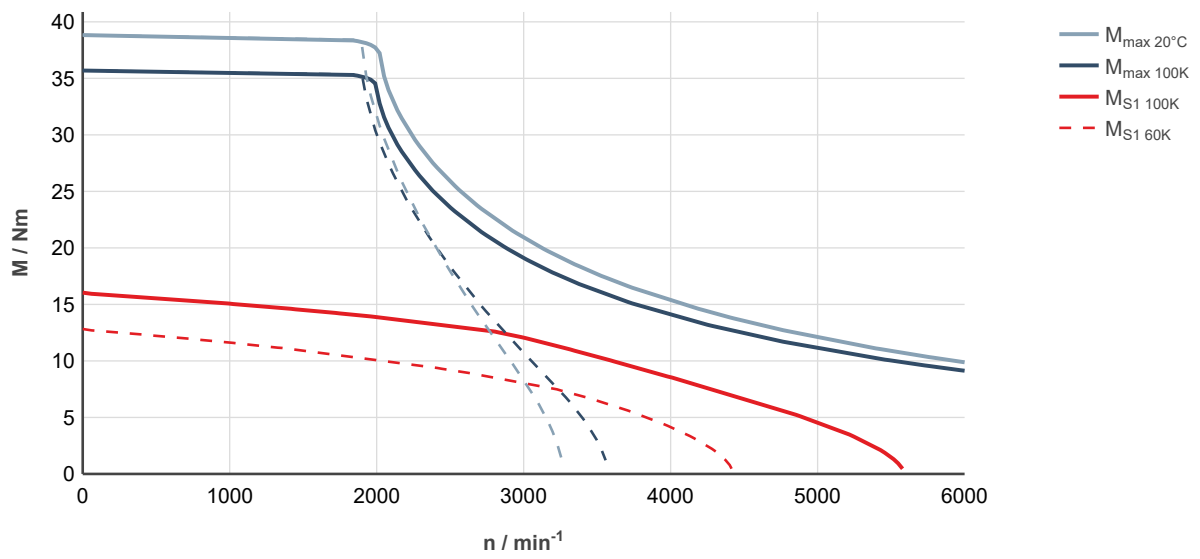

Fig. 91: MS2N07-C0BNN-___0-___-_, ctrlX DRIVE, uncontrolled supply 3 × AC 400 V

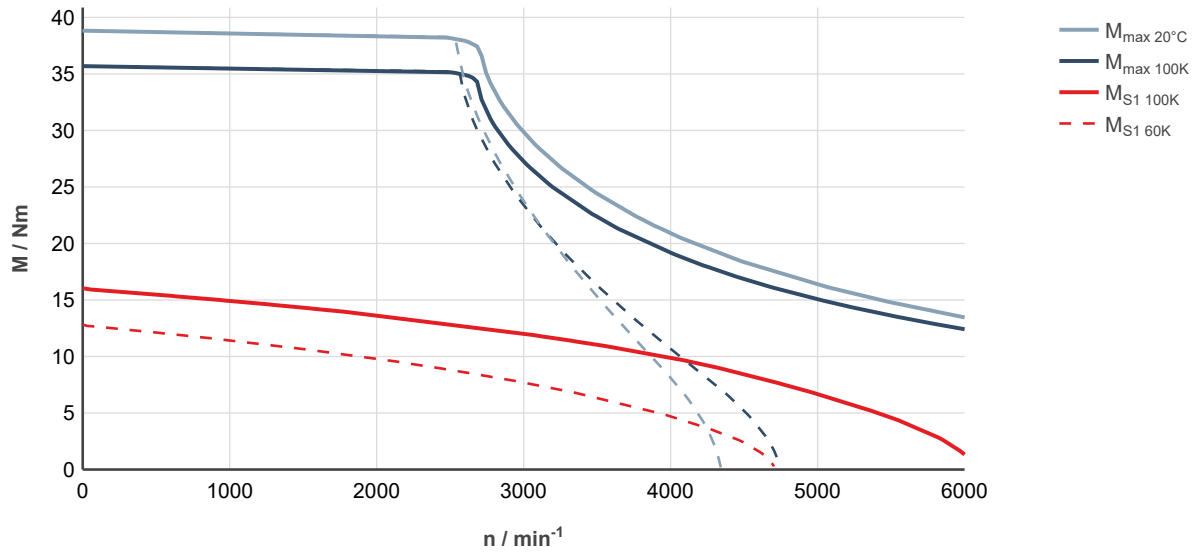

Fig. 92: MS2N07-C0BNN-___0-___-_, ctrlX DRIVE, controlled supply 3 × AC 400 ... 480 V

MS2N07-C0BQN

Designation	Symbol	Unit	MS2N07-C0BQN-__0-_N	MS2N07-C0BQN-__1-_N
Standstill torque - 60K ¹⁾	M _{0 60K}	Nm	12.8	
Standstill current - 60K	I _{0 60K}	A	10.1	
Standstill torque - 100K ¹⁾	M _{0 100K}	Nm	16.0	
Standstill current - 100K	I _{0 100K}	A	12.9	
Moment of inertia of rotor ¹⁾	J _{rot}	kg*m ²	0.0012	0.00146
Rated speed - 100K	n _{N 100K}	1/min	4070	
Rated torque - 100K ¹⁾	M _{N 100K}	Nm	9.0	
Rated current - 100K	I _{N 100K}	A	7.5	
Rated power - 100K ¹⁾	P _{N 100K}	kW	3.84	
Maximum torque 20 °C (cold) ¹⁾	M _{max 20°C}	Nm	38.8	
Maximum torque 100K (warm) ¹⁾	M _{max 100K}	Nm	35.7	
Maximum current	I _{max(rms)}	A	36.4	
Maximum speed (electrical)	n _{max el}	1/min	6000	
Maximum speed (mechanical)	n _{max mech}	1/min	6000	
Number of pole pairs	p		5	
Torque constant at 20 °C ¹⁾	K _m	Nm/A	1.37	
Voltage constant at 20 °C ¹⁾	K _E	V/1000 min ⁻¹	83.1	
Winding resistance at 20 °C	R ₁₂	Ohm	0.776	
Winding inductance	L _{12,min}	mH	10.5	
Leakage capacitance of the component	C _{ab}	nF	2.2	
Thermal time constant of winding	T _{th,W}	s	46.4	
Thermal time constant of motor	T _{th,M}	min	14.8	
Mass	m _{mot}	kg	12.0	14.0
Holding brake				
Holding torque	M ₄	Nm	0	20.00
Rated voltage	U _N	V	0	24
Rated current	I _N	A	0	0.78
Maximum connection time	t ₁	ms	0	40
Maximum disconnection time	t ₂	ms	0	100
1) For tolerance details refer to chapter 6.4 Tolerances			Latest amendment: 2017-08-09	

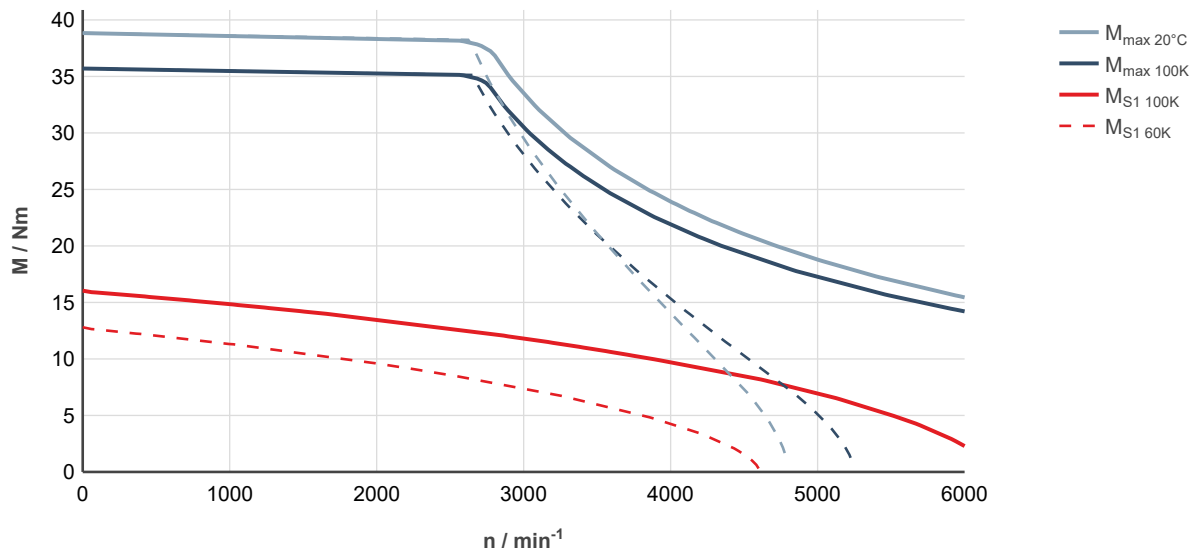

Fig. 93: MS2N07-C0BQN-___0-___-_, ctrlX DRIVE, uncontrolled supply 3 × AC 400 V

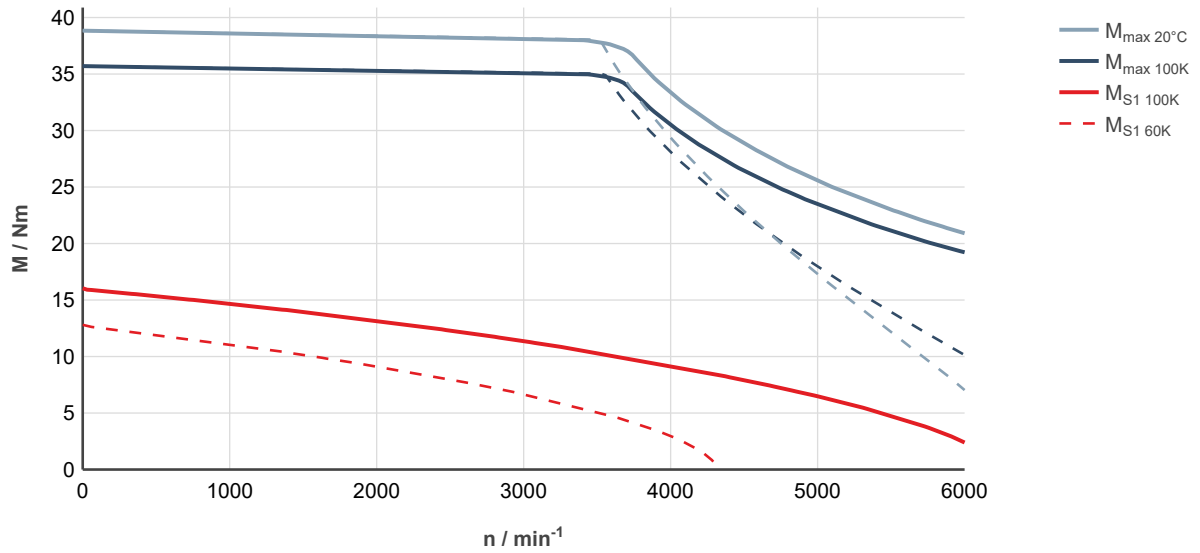

Fig. 94: MS2N07-C0BQN-___0-___-_, ctrlX DRIVE, controlled supply 3 × AC 400 ... 480 V

MS2N07-C1BNN

Designation	Symbol	Unit	MS2N07-C1BNN-__0-_N	MS2N07-C1BNN-__1-_N
Standstill torque - 60K ¹⁾	M _{0 60K}	Nm	11.5	
Standstill current - 60K	I _{0 60K}	A	6.6	
Standstill torque - 100K ¹⁾	M _{0 100K}	Nm	14.5	
Standstill current - 100K	I _{0 100K}	A	8.35	
Moment of inertia of rotor ¹⁾	J _{rot}	kg*m ²	0.00305	0.00331
Rated speed - 100K	n _{N 100K}	1/min	3020	
Rated torque - 100K ¹⁾	M _{N 100K}	Nm	9.60	
Rated current - 100K	I _{N 100K}	A	5.80	
Rated power - 100K ¹⁾	P _{N 100K}	kW	3.04	
Maximum torque 20 °C (cold) ¹⁾	M _{max 20°C}	Nm	46.0	
Maximum torque 100K (warm) ¹⁾	M _{max 100K}	Nm	42.2	
Maximum current	I _{max(rms)}	A	29.5	
Maximum speed (electrical)	n _{max el}	1/min	6000	
Maximum speed (mechanical)	n _{max mech}	1/min	6000	
Number of pole pairs	p		5	
Torque constant at 20 °C ¹⁾	K _m	Nm/A	1.88	
Voltage constant at 20 °C ¹⁾	K _E	V/1000 min ⁻¹	114.0	
Winding resistance at 20 °C	R ₁₂	Ohm	1.8	
Winding inductance	L _{12,min}	mH	15.2	
Leakage capacitance of the component	C _{ab}	nF	1.85	
Thermal time constant of winding	T _{th,W}	s	37.8	
Thermal time constant of motor	T _{th,M}	min	14.8	
Mass	m _{mot}	kg	12.0	14.0
Holding brake				
Holding torque	M ₄	Nm	0	20.00
Rated voltage	U _N	V	0	24
Rated current	I _N	A	0	0.78
Maximum connection time	t ₁	ms	0	40
Maximum disconnection time	t ₂	ms	0	100
1) For tolerance details refer to chapter 6.4 Tolerances			Latest amendment: 2017-01-18	

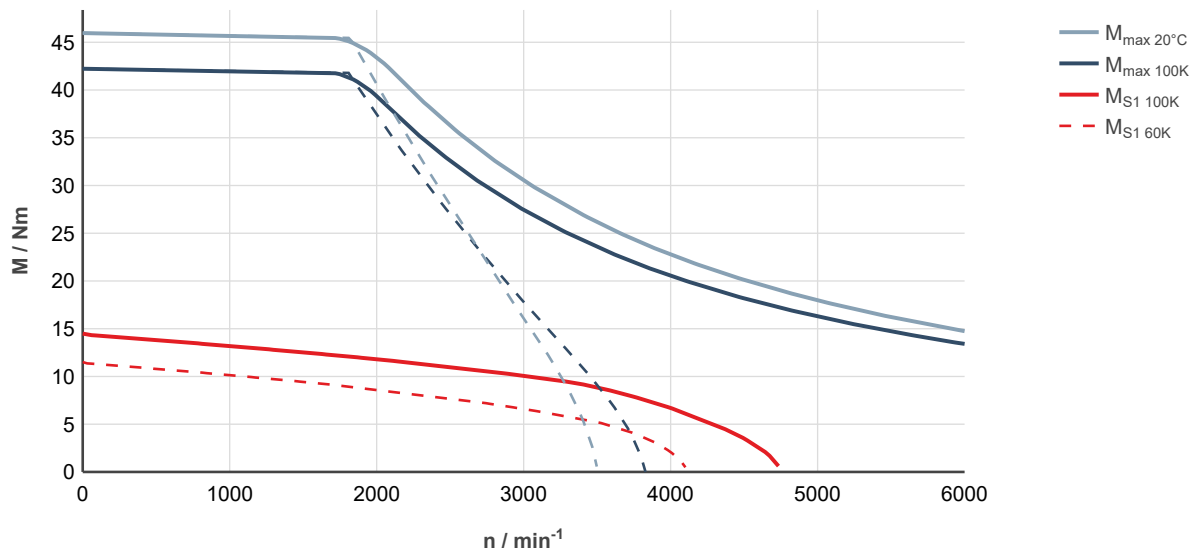

Fig. 95: MS2N07-C1BNN-___0-___-__, ctrlX DRIVE, uncontrolled supply 3 × AC 400 V

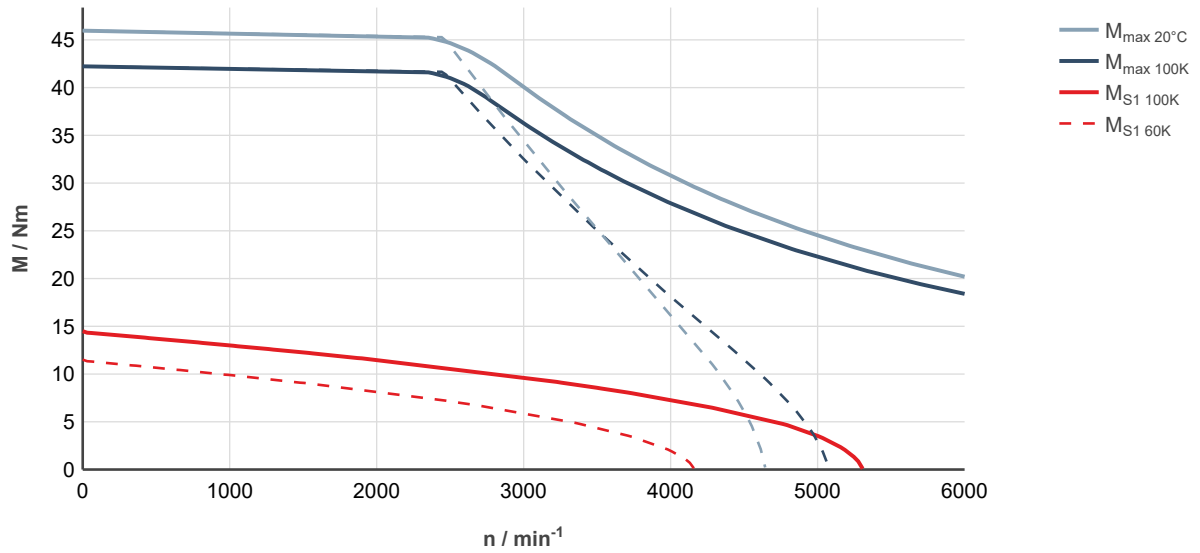

Fig. 96: MS2N07-C1BNN-___0-___-__, ctrlX DRIVE, controlled supply 3 × AC 400 ... 480 V

MS2N07-C1BRN

Designation	Symbol	Unit	MS2N07-C1BRN-__0-_N	MS2N07-C1BRN-__1-_N
Standstill torque - 60K ¹⁾	M _{0 60K}	Nm	11.5	
Standstill current - 60K	I _{0 60K}	A	9.55	
Standstill torque - 100K ¹⁾	M _{0 100K}	Nm	14.5	
Standstill current - 100K	I _{0 100K}	A	12.1	
Moment of inertia of rotor ¹⁾	J _{rot}	kg*m ²	0.00305	0.00331
Rated speed - 100K	n _{N 100K}	1/min	3610	
Rated torque - 100K ¹⁾	M _{N 100K}	Nm	7.05	
Rated current - 100K	I _{N 100K}	A	6.3	
Rated power - 100K ¹⁾	P _{N 100K}	kW	2.66	
Maximum torque 20 °C (cold) ¹⁾	M _{max 20°C}	Nm	46.0	
Maximum torque 100K (warm) ¹⁾	M _{max 100K}	Nm	42.2	
Maximum current	I _{max(rms)}	A	42.7	
Maximum speed (electrical)	n _{max el}	1/min	6000	
Maximum speed (mechanical)	n _{max mech}	1/min	6000	
Number of pole pairs	p		5	
Torque constant at 20 °C ¹⁾	K _m	Nm/A	1.3	
Voltage constant at 20 °C ¹⁾	K _E	V/1000 min ⁻¹	78.7	
Winding resistance at 20 °C	R ₁₂	Ohm	0.895	
Winding inductance	L _{12,min}	mH	7.28	
Leakage capacitance of the component	C _{ab}	nF	1.65	
Thermal time constant of winding	T _{th,W}	s	37.8	
Thermal time constant of motor	T _{th,M}	min	14.8	
Mass	m _{mot}	kg	12.0	14.0
Holding brake				
Holding torque	M ₄	Nm	0	20.00
Rated voltage	U _N	V	0	24
Rated current	I _N	A	0	0.78
Maximum connection time	t ₁	ms	0	40
Maximum disconnection time	t ₂	ms	0	100

1) For tolerance details refer to [chapter 6.4 Tolerances](#)

Latest amendment: 2017-08-09

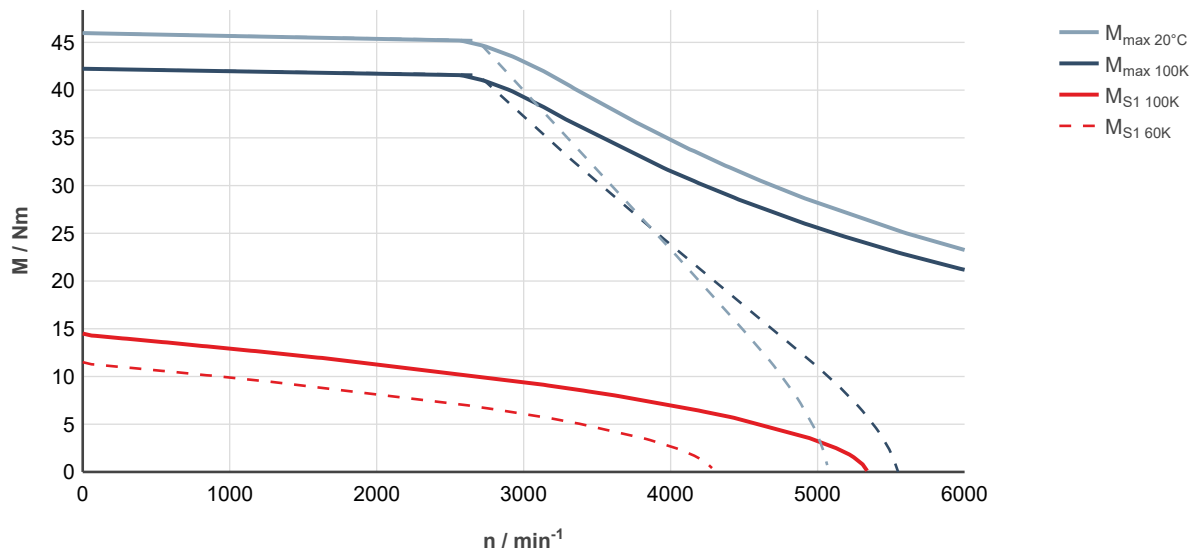

Fig. 97: MS2N07-C1BRN-___0-___-__, ctrlX DRIVE, uncontrolled supply 3 × AC 400 V

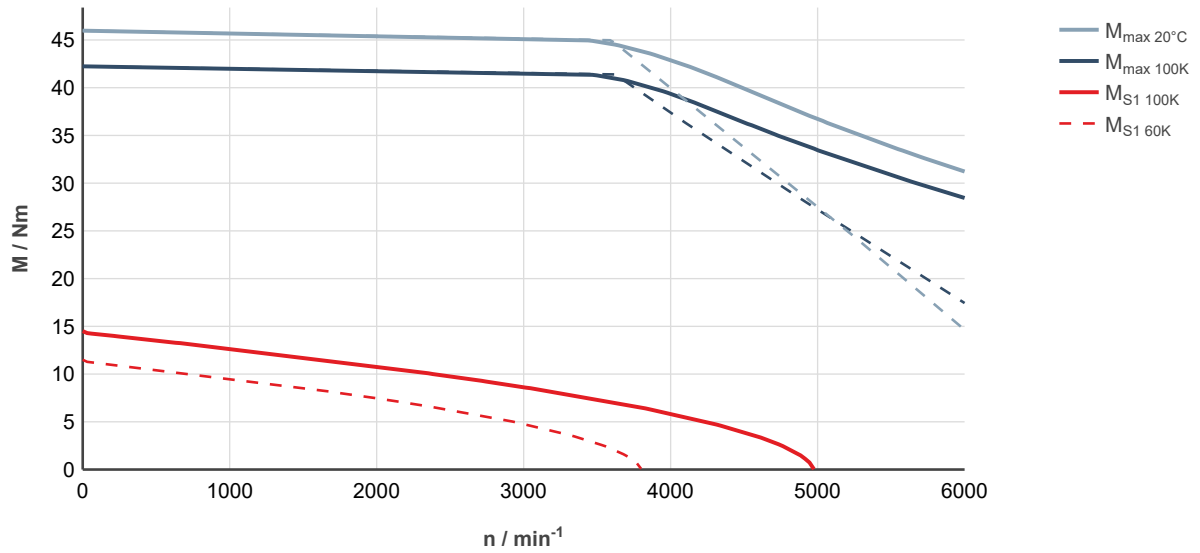

Fig. 98: MS2N07-C1BRN-___0-___-__, ctrlX DRIVE, controlled supply 3 × AC 400 ... 480 V

MS2N07-D0BFN

Designation	Symbol	Unit	MS2N07-D0BFN-__0-_N	MS2N07-D0BFN-__2-_N
Standstill torque - 60K ¹⁾	M _{0 60K}	Nm	22.0	
Standstill current - 60K	I _{0 60K}	A	5.8	
Standstill torque - 100K ¹⁾	M _{0 100K}	Nm	28.2	
Standstill current - 100K	I _{0 100K}	A	7.55	
Moment of inertia of rotor ¹⁾	J _{rot}	kg*m ²	0.0021	0.00251
Rated speed - 100K	n _{N 100K}	1/min	1340	
Rated torque - 100K ¹⁾	M _{N 100K}	Nm	24.9	
Rated current - 100K	I _{N 100K}	A	6.75	
Rated power - 100K ¹⁾	P _{N 100K}	kW	3.49	
Maximum torque 20 °C (cold) ¹⁾	M _{max 20°C}	Nm	79.7	
Maximum torque 100K (warm) ¹⁾	M _{max 100K}	Nm	73.2	
Maximum current	I _{max(rms)}	A	24.8	
Maximum speed (electrical)	n _{max el}	1/min	3000	
Maximum speed (mechanical)	n _{max mech}	1/min	6000	
Number of pole pairs	p		5	
Torque constant at 20 °C ¹⁾	K _m	Nm/A	4.09	
Voltage constant at 20 °C ¹⁾	K _E	V/1000 min ⁻¹	248	
Winding resistance at 20 °C	R ₁₂	Ohm	2.71	
Winding inductance	L _{12,min}	mH	45.67	
Leakage capacitance of the component	C _{ab}	nF	4.71	
Thermal time constant of winding	T _{th,W}	s	54	
Thermal time constant of motor	T _{th,M}	min	18.7	
Mass	m _{mot}	kg	17.5	20
Holding brake				
Holding torque	M ₄	Nm	0	36.00
Rated voltage	U _N	V	0	24
Rated current	I _N	A	0	0.94
Maximum connection time	t ₁	ms	0	60
Maximum disconnection time	t ₂	ms	0	200
1) For tolerance details refer to chapter 6.4 Tolerances			Latest amendment: 2020-01-31	

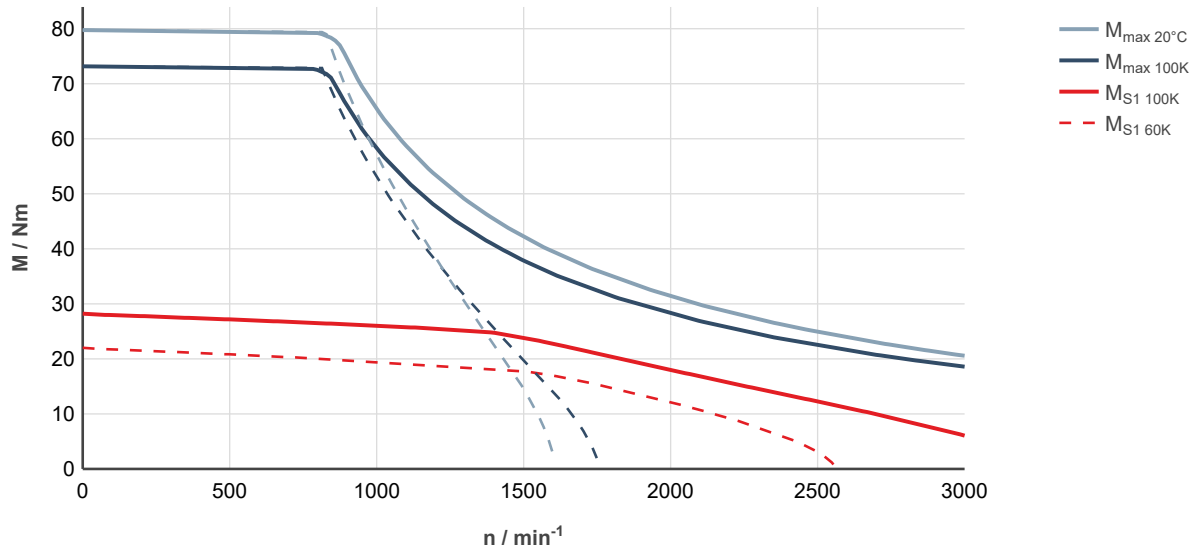

Fig. 99: MS2N07-D0BFN-___0-___-__, ctrlX DRIVE, uncontrolled supply 3 × AC 400 V

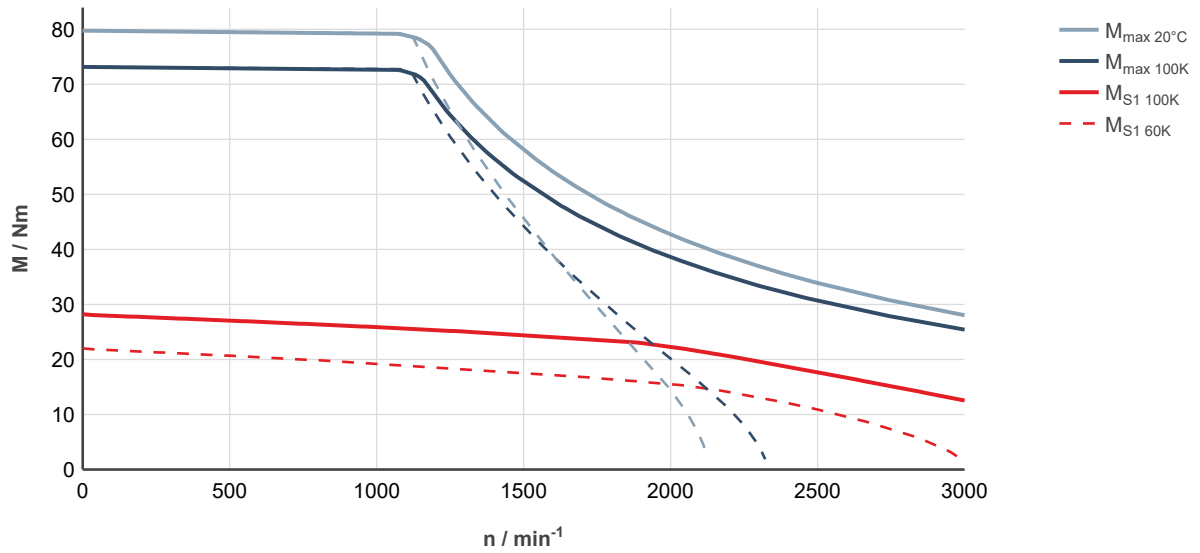

Fig. 100: MS2N07-D0BFN-___0-___-__, ctrlX DRIVE, controlled supply 3 × AC 400 ... 480 V

MS2N07-D0BHN

Designation	Symbol	Unit	MS2N07-D0BHN-__0-_N	MS2N07-D0BHN-__2-_N
Standstill torque - 60K ¹⁾	M _{0 60K}	Nm	22.0	
Standstill current - 60K	I _{0 60K}	A	8.55	
Standstill torque - 100K ¹⁾	M _{0 100K}	Nm	28.2	
Standstill current - 100K	I _{0 100K}	A	11.1	
Moment of inertia of rotor ¹⁾	J _{rot}	kg*m ²	0.0021	0.00251
Rated speed - 100K	n _{N 100K}	1/min	2000	
Rated torque - 100K ¹⁾	M _{N 100K}	Nm	22.0	
Rated current - 100K	I _{N 100K}	A	8.85	
Rated power - 100K ¹⁾	P _{N 100K}	kW	4.6	
Maximum torque 20 °C (cold) ¹⁾	M _{max 20°C}	Nm	79.7	
Maximum torque 100K (warm) ¹⁾	M _{max 100K}	Nm	73.2	
Maximum current	I _{max(rms)}	A	36.4	
Maximum speed (electrical)	n _{max el}	1/min	4000	
Maximum speed (mechanical)	n _{max mech}	1/min	6000	
Number of pole pairs	p		5	
Torque constant at 20 °C ¹⁾	K _m	Nm/A	2.76	
Voltage constant at 20 °C ¹⁾	K _E	V/1000 min ⁻¹	167.5	
Winding resistance at 20 °C	R ₁₂	Ohm	1.30	
Winding inductance	L _{12,min}	mH	20.2	
Leakage capacitance of the component	C _{ab}	nF	4.1	
Thermal time constant of winding	T _{th,W}	s	54.0	
Thermal time constant of motor	T _{th,M}	min	18.7	
Mass	m _{mot}	kg	17.5	20
Holding brake				
Holding torque	M ₄	Nm	0	36.00
Rated voltage	U _N	V	0	24
Rated current	I _N	A	0	0.94
Maximum connection time	t ₁	ms	0	60
Maximum disconnection time	t ₂	ms	0	200

1) For tolerance details refer to [chapter 6.4 Tolerances](#)

Latest amendment: 2017-08-09

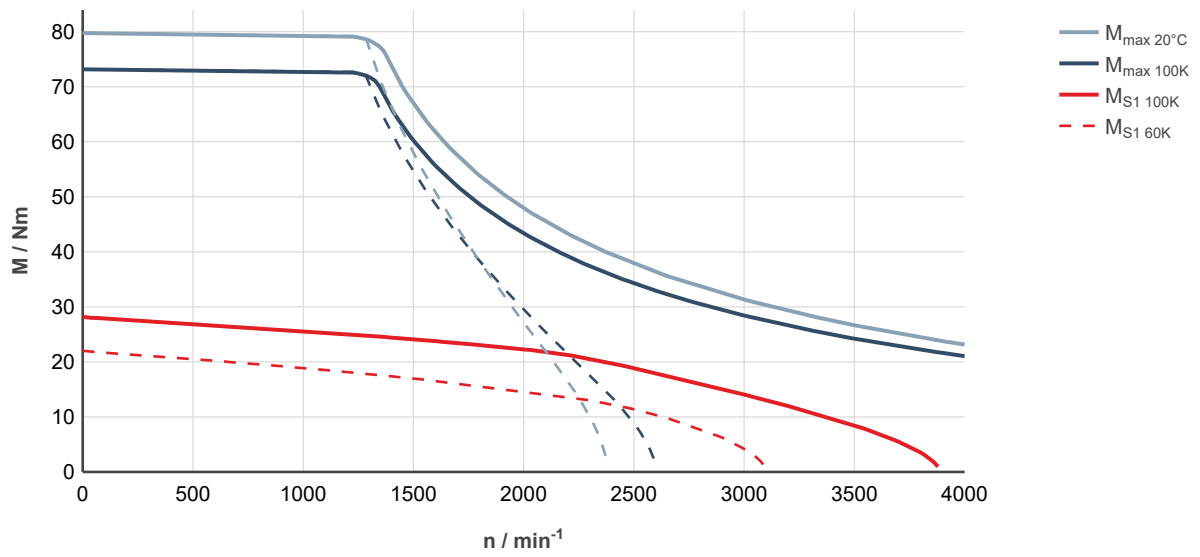

Fig. 101: MS2N07-D0BHN-___0-___-_, ctrlX DRIVE, uncontrolled supply 3 × AC 400 V

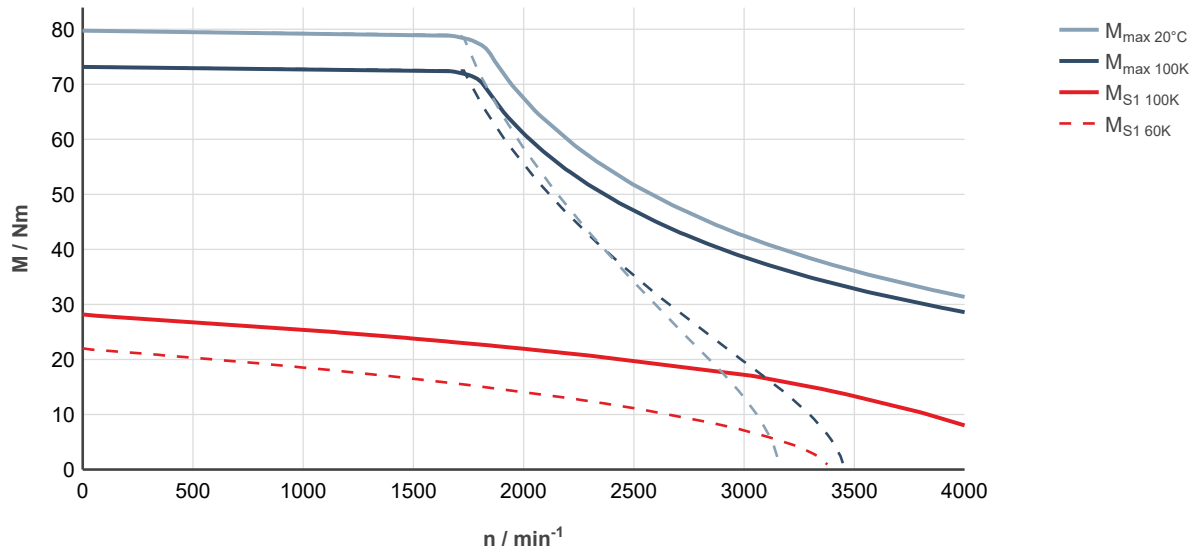

Fig. 102: MS2N07-D0BHN-___0-___-_, ctrlX DRIVE, controlled supply 3 × AC 400 ... 480 V

MS2N07-D0BNN

Designation	Symbol	Unit	MS2N07-D0BNN-__0-_N	MS2N07-D0BNN-__2-_N
Standstill torque - 60K ¹⁾	M _{0 60K}	Nm	22.0	
Standstill current - 60K	I _{0 60K}	A	11.55	
Standstill torque - 100K ¹⁾	M _{0 100K}	Nm	28.2	
Standstill current - 100K	I _{0 100K}	A	15.0	
Moment of inertia of rotor ¹⁾	J _{rot}	kg*m ²	0.0021	0.00251
Rated speed - 100K	n _{N 100K}	1/min	2940	
Rated torque - 100K ¹⁾	M _{N 100K}	Nm	16.9	
Rated current - 100K	I _{N 100K}	A	9.35	
Rated power - 100K ¹⁾	P _{N 100K}	kW	5.2	
Maximum torque 20 °C (cold) ¹⁾	M _{max 20°C}	Nm	79.7	
Maximum torque 100K (warm) ¹⁾	M _{max 100K}	Nm	73.2	
Maximum current	I _{max(rms)}	A	49.5	
Maximum speed (electrical)	n _{max el}	1/min	6000	
Maximum speed (mechanical)	n _{max mech}	1/min	6000	
Number of pole pairs	p		5	
Torque constant at 20 °C ¹⁾	K _m	Nm/A	2.04	
Voltage constant at 20 °C ¹⁾	K _E	V/1000 min ⁻¹	124.1	
Winding resistance at 20 °C	R ₁₂	Ohm	0.671	
Winding inductance	L _{12,min}	mH	10.0	
Leakage capacitance of the component	C _{ab}	nF	4.0	
Thermal time constant of winding	T _{th,W}	s	54.0	
Thermal time constant of motor	T _{th,M}	min	18.7	
Mass	m _{mot}	kg	17.5	20
Holding brake				
Holding torque	M ₄	Nm	0	36.00
Rated voltage	U _N	V	0	24
Rated current	I _N	A	0	0.94
Maximum connection time	t ₁	ms	0	60
Maximum disconnection time	t ₂	ms	0	200

1) For tolerance details refer to [chapter 6.4 Tolerances](#) Latest amendment: 2017-03-07

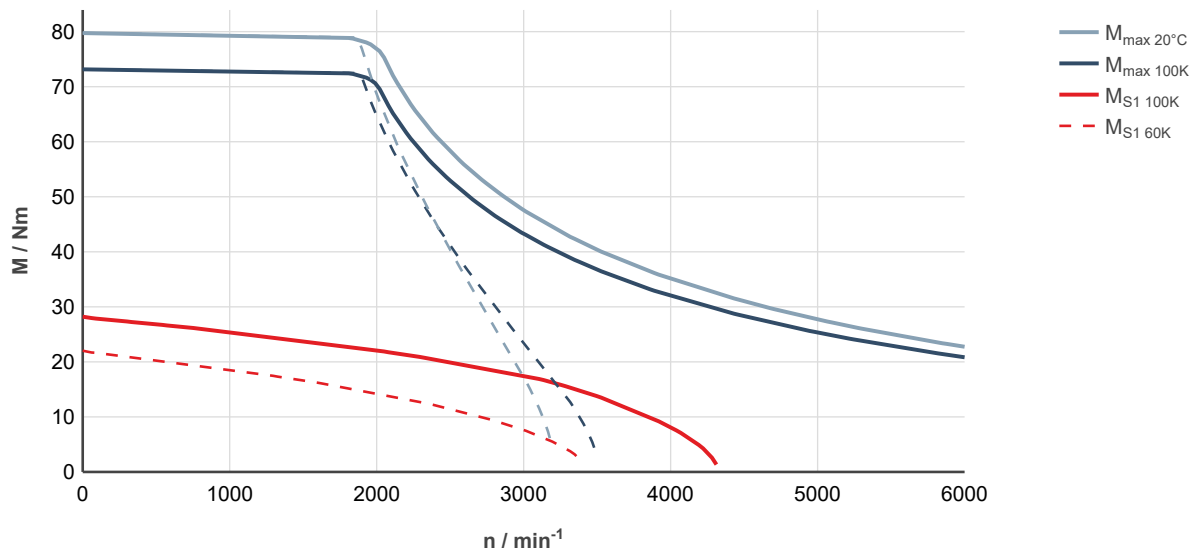

Fig. 103: MS2N07-D0BNN-___0-___-, ctrlX DRIVE, uncontrolled supply 3 × AC 400 V

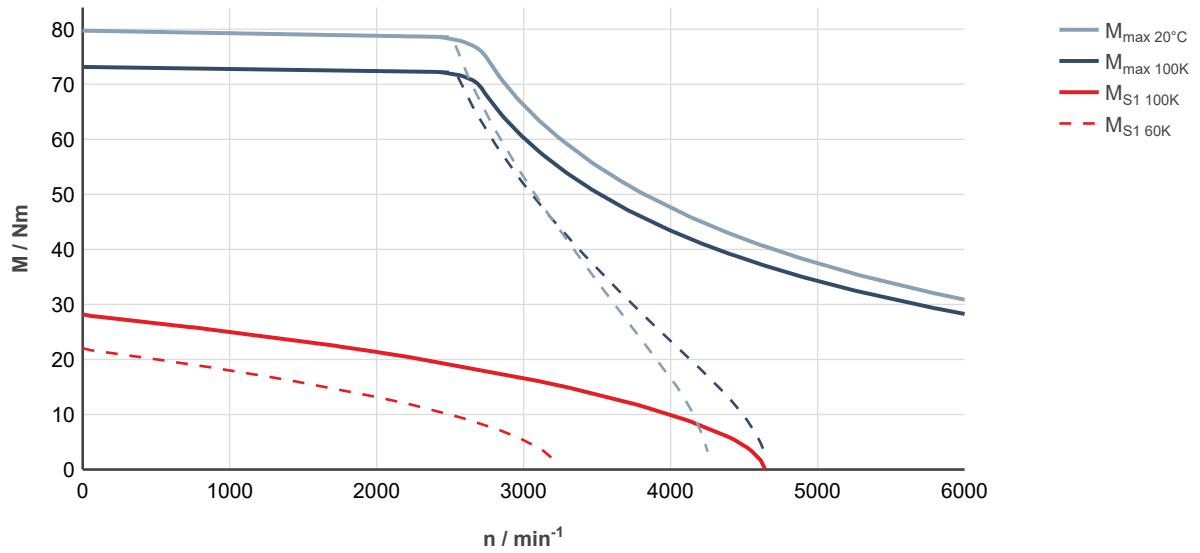

Fig. 104: MS2N07-D0BNN-___0-___-, ctrlX DRIVE, controlled supply 3 × AC 400 ... 480 V

MS2N07-D0BRN

Designation	Symbol	Unit	MS2N07-D0BRN-__0-_N	MS2N07-D0BRN-__2-_N
Standstill torque - 60K ¹⁾	M _{0 60K}	Nm	22.0	
Standstill current - 60K	I _{0 60K}	A	17.1	
Standstill torque - 100K ¹⁾	M _{0 100K}	Nm	28.2	
Standstill current - 100K	I _{0 100K}	A	22.3	
Moment of inertia of rotor ¹⁾	J _{rot}	kg*m ²	0.0021	0.00251
Rated speed - 100K	n _{N 100K}	1/min	3020	
Rated torque - 100K ¹⁾	M _{N 100K}	Nm	14.7	
Rated current - 100K	I _{N 100K}	A	12.15	
Rated power - 100K ¹⁾	P _{N 100K}	kW	4.64	
Maximum torque 20 °C (cold) ¹⁾	M _{max 20°C}	Nm	79.7	
Maximum torque 100K (warm) ¹⁾	M _{max 100K}	Nm	73.2	
Maximum current	I _{max(rms)}	A	72.7	
Maximum speed (electrical)	n _{max el}	1/min	6000	
Maximum speed (mechanical)	n _{max mech}	1/min	6000	
Number of pole pairs	p		5	
Torque constant at 20 °C ¹⁾	K _m	Nm/A	1.38	
Voltage constant at 20 °C ¹⁾	K _E	V/1000 min ⁻¹	83.9	
Winding resistance at 20 °C	R ₁₂	Ohm	0.327	
Winding inductance	L _{12,min}	mH	5.06	
Leakage capacitance of the component	C _{ab}	nF	3.95	
Thermal time constant of winding	T _{th,W}	s	54.0	
Thermal time constant of motor	T _{th,M}	min	18.7	
Mass	m _{mot}	kg	17.5	20
Holding brake				
Holding torque	M ₄	Nm	0	36.00
Rated voltage	U _N	V	0	24
Rated current	I _N	A	0	0.94
Maximum connection time	t ₁	ms	0	60
Maximum disconnection time	t ₂	ms	0	200

1) For tolerance details refer to [chapter 6.4 Tolerances](#)

Latest amendment: 2017-08-09

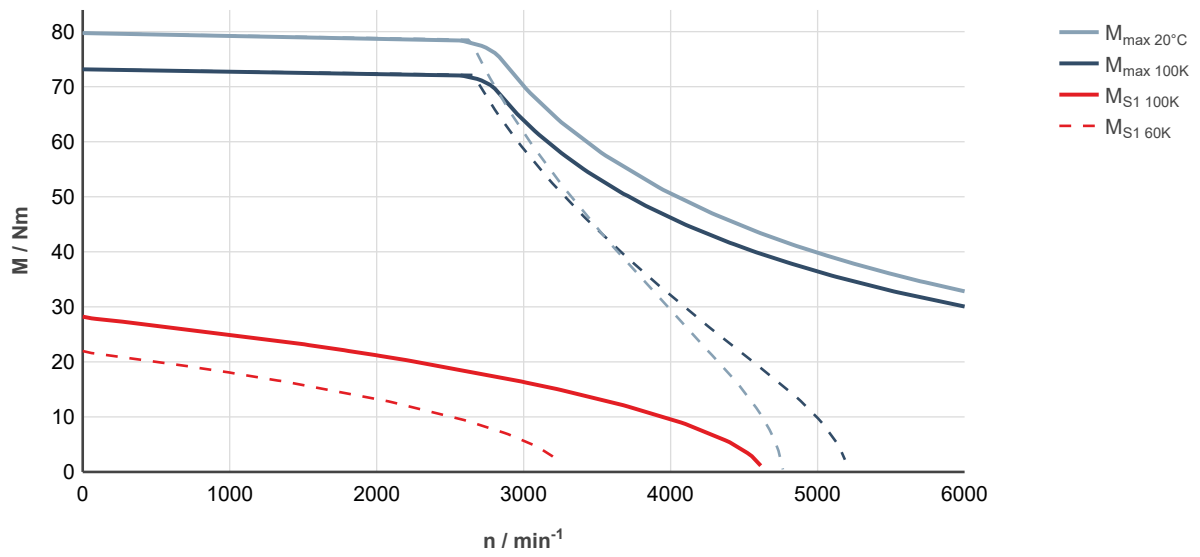

Fig. 105: MS2N07-D0BRN-___0-___-_, ctrlX DRIVE, uncontrolled supply 3 × AC 400 V

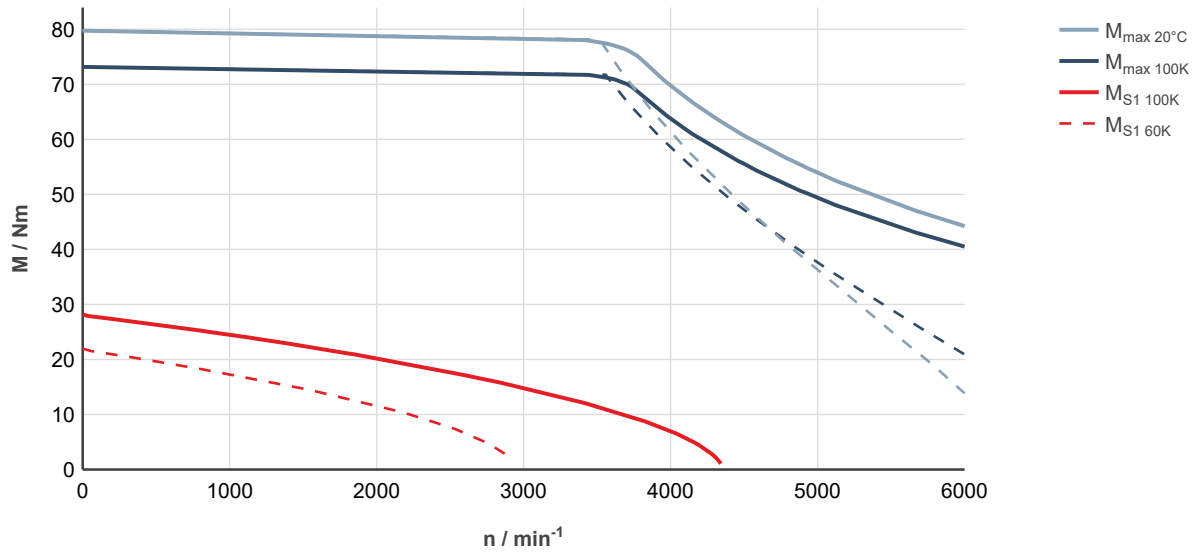

Fig. 106: MS2N07-D0BRN-___0-___-_, ctrlX DRIVE, controlled supply 3 × AC 400 ... 480 V

MS2N07-D1BFN

Designation	Symbol	Unit	MS2N07-D1BFN-__0-_N	MS2N07-D1BFN-__2-_N
Standstill torque - 60K ¹⁾	M _{0 60K}	Nm	18.9	
Standstill current - 60K	I _{0 60K}	A	5.45	
Standstill torque - 100K ¹⁾	M _{0 100K}	Nm	23.8	
Standstill current - 100K	I _{0 100K}	A	6.9	
Moment of inertia of rotor ¹⁾	J _{rot}	kg*m ²	0.00529	0.00570
Rated speed - 100K	n _{N 100K}	1/min	1500	
Rated torque - 100K ¹⁾	M _{N 100K}	Nm	20.9	
Rated current - 100K	I _{N 100K}	A	6.15	
Rated power - 100K ¹⁾	P _{N 100K}	kW	3.28	
Maximum torque 20 °C (cold) ¹⁾	M _{max 20°C}	Nm	92.5	
Maximum torque 100K (warm) ¹⁾	M _{max 100K}	Nm	84.8	
Maximum current	I _{max(rms)}	A	29.5	
Maximum speed (electrical)	n _{max el}	1/min	3000	
Maximum speed (mechanical)	n _{max mech}	1/min	6000	
Number of pole pairs	p		5	
Torque constant at 20 °C ¹⁾	K _m	Nm/A	3.73	
Voltage constant at 20 °C ¹⁾	K _E	V/1000 min ⁻¹	226.5	
Winding resistance at 20 °C	R ₁₂	Ohm	2.93	
Winding inductance	L _{12,min}	mH	28.7	
Leakage capacitance of the component	C _{ab}	nF	3.65	
Thermal time constant of winding	T _{th,W}	s	43.8	
Thermal time constant of motor	T _{th,M}	min	18.7	
Mass	m _{mot}	kg	17.5	20.0
Holding brake				
Holding torque	M ₄	Nm	0	36.00
Rated voltage	U _N	V	0	24
Rated current	I _N	A	0	0.94
Maximum connection time	t ₁	ms	0	60
Maximum disconnection time	t ₂	ms	0	200

1) For tolerance details refer to [chapter 6.4 Tolerances](#)

Latest amendment: 2020-02-10

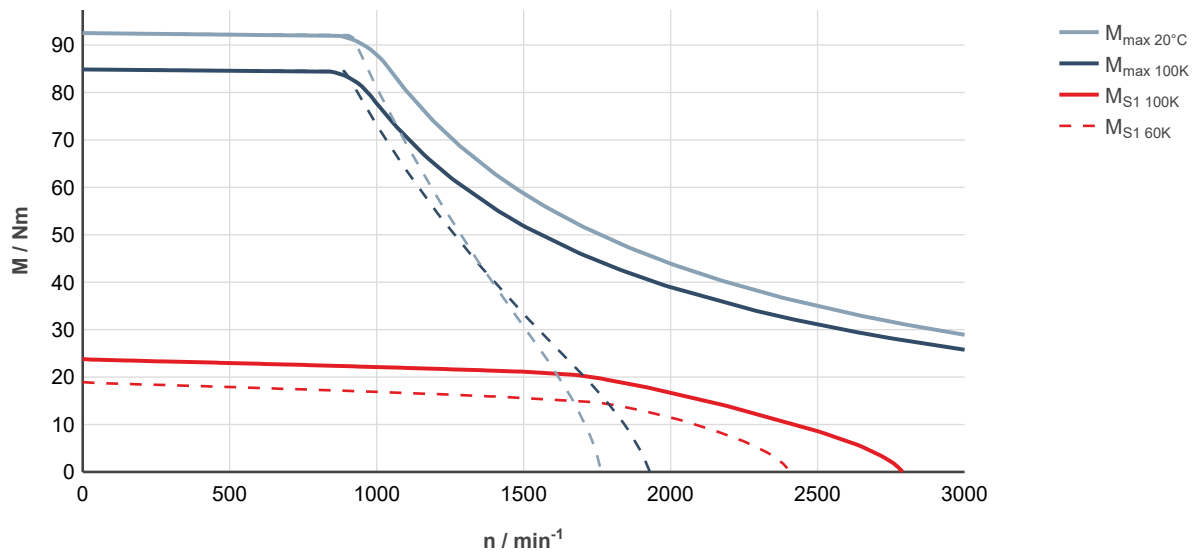

Fig. 107: MS2N07-D1BFN-___0-___-_, ctrlX DRIVE, uncontrolled supply 3 × AC 400 V

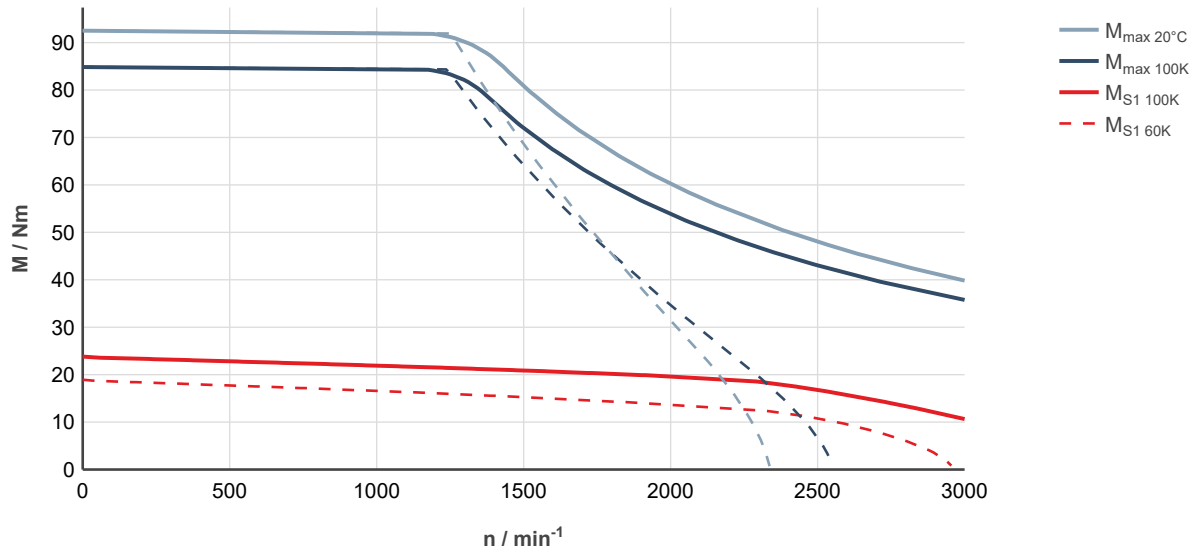

Fig. 108: MS2N07-D1BFN-___0-___-_, ctrlX DRIVE, controlled supply 3 × AC 400 ... 480 V

MS2N07-D1BHN

Designation	Symbol	Unit	MS2N07-D1BHN-__0-_N	MS2N07-D1BHN-__2-_N
Standstill torque - 60K ¹⁾	M _{0 60K}	Nm	18.9	
Standstill current - 60K	I _{0 60K}	A	7.8	
Standstill torque - 100K ¹⁾	M _{0 100K}	Nm	23.8	
Standstill current - 100K	I _{0 100K}	A	9.9	
Moment of inertia of rotor ¹⁾	J _{rot}	kg*m ²	0.00529	0.00570
Rated speed - 100K	n _{N 100K}	1/min	2000	
Rated torque - 100K ¹⁾	M _{N 100K}	Nm	18.5	
Rated current - 100K	I _{N 100K}	A	7.95	
Rated power - 100K ¹⁾	P _{N 100K}	kW	3.87	
Maximum torque 20 °C (cold) ¹⁾	M _{max 20°C}	Nm	92.5	
Maximum torque 100K (warm) ¹⁾	M _{max 100K}	Nm	84.8	
Maximum current	I _{max(rms)}	A	42.7	
Maximum speed (electrical)	n _{max el}	1/min	4000	
Maximum speed (mechanical)	n _{max mech}	1/min	6000	
Number of pole pairs	p		5	
Torque constant at 20 °C ¹⁾	K _m	Nm/A	2.59	
Voltage constant at 20 °C ¹⁾	K _E	V/1000 min ⁻¹	157.5	
Winding resistance at 20 °C	R ₁₂	Ohm	1.56	
Winding inductance	L _{12,min}	mH	12.8	
Leakage capacitance of the component	C _{ab}	nF	3.1	
Thermal time constant of winding	T _{th,W}	s	43.8	
Thermal time constant of motor	T _{th,M}	min	18.7	
Mass	m _{mot}	kg	17.5	20.0
Holding brake				
Holding torque	M ₄	Nm	0	36.00
Rated voltage	U _N	V	0	24
Rated current	I _N	A	0	0.94
Maximum connection time	t ₁	ms	0	60
Maximum disconnection time	t ₂	ms	0	200

1) For tolerance details refer to [chapter 6.4 Tolerances](#)

Latest amendment: 2017-08-09

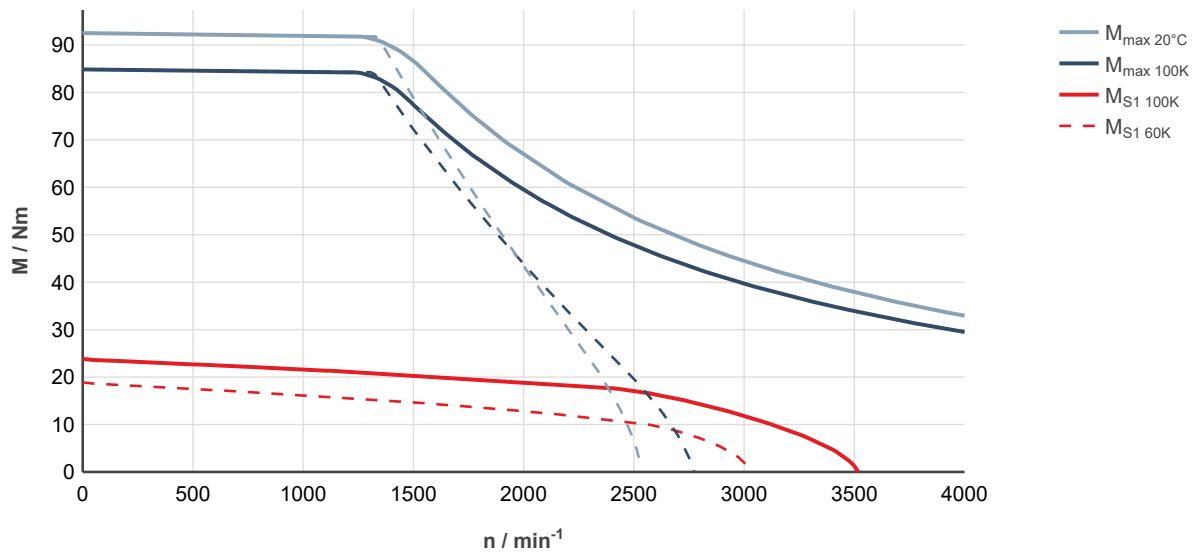

Fig. 109: MS2N07-D1BHN-___0-___-_, ctrlX DRIVE, uncontrolled supply 3 × AC 400 V

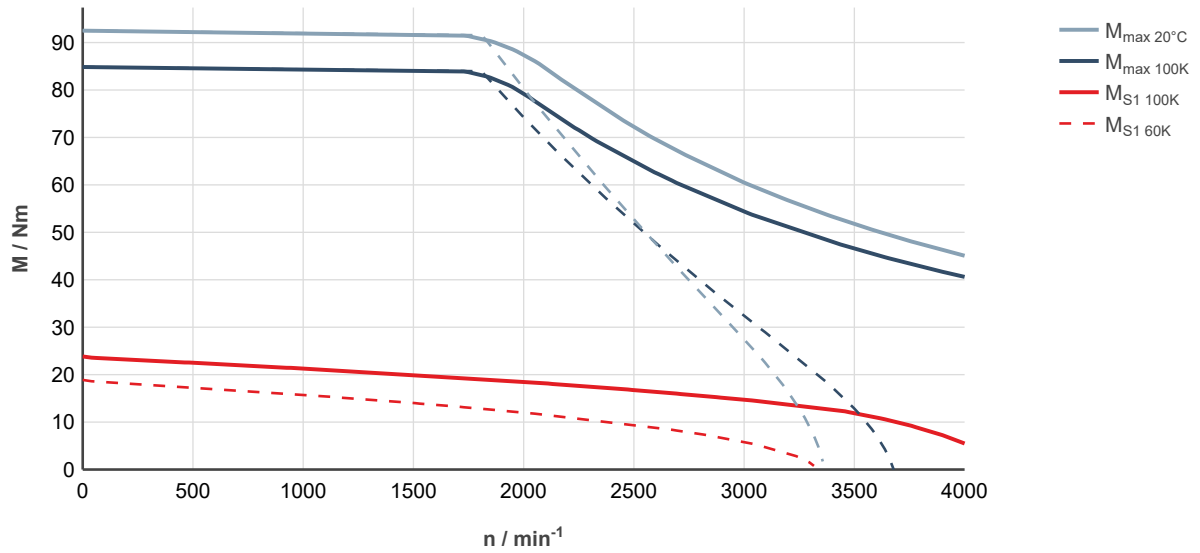

Fig. 110: MS2N07-D1BHN-___0-___-_, ctrlX DRIVE, controlled supply 3 × AC 400 ... 480 V

MS2N07-D1BNN

Designation	Symbol	Unit	MS2N07-D1BNN-__0-_N	MS2N07-D1BNN-__2-_N
Standstill torque - 60K ¹⁾	M _{0 60K}	Nm	18.9	
Standstill current - 60K	I _{0 60K}	A	9.9	
Standstill torque - 100K ¹⁾	M _{0 100K}	Nm	23.8	
Standstill current - 100K	I _{0 100K}	A	12.5	
Moment of inertia of rotor ¹⁾	J _{rot}	kg*m ²	0.00529	0.00570
Rated speed - 100K	n _{N 100K}	1/min	3000	
Rated torque - 100K ¹⁾	M _{N 100K}	Nm	13.6	
Rated current - 100K	I _{N 100K}	A	7.6	
Rated power - 100K ¹⁾	P _{N 100K}	kW	4.28	
Maximum torque 20 °C (cold) ¹⁾	M _{max 20°C}	Nm	92.5	
Maximum torque 100K (warm) ¹⁾	M _{max 100K}	Nm	84.8	
Maximum current	I _{max(rms)}	A	54.1	
Maximum speed (electrical)	n _{max el}	1/min	6000	
Maximum speed (mechanical)	n _{max mech}	1/min	6000	
Number of pole pairs	p		5	
Torque constant at 20 °C ¹⁾	K _m	Nm/A	2.05	
Voltage constant at 20 °C ¹⁾	K _E	V/1000 min ⁻¹	124.3	
Winding resistance at 20 °C	R ₁₂	Ohm	0.942	
Winding inductance	L _{12,min}	mH	7.9	
Leakage capacitance of the component	C _{ab}	nF	3.0	
Thermal time constant of winding	T _{th,W}	s	43.8	
Thermal time constant of motor	T _{th,M}	min	18.7	
Mass	m _{mot}	kg	17.5	20.0
Holding brake				
Holding torque	M ₄	Nm	0	36.00
Rated voltage	U _N	V	0	24
Rated current	I _N	A	0	0.94
Maximum connection time	t ₁	ms	0	60
Maximum disconnection time	t ₂	ms	0	200
1) For tolerance details refer to chapter 6.4 Tolerances			Latest amendment: 2017-08-09	

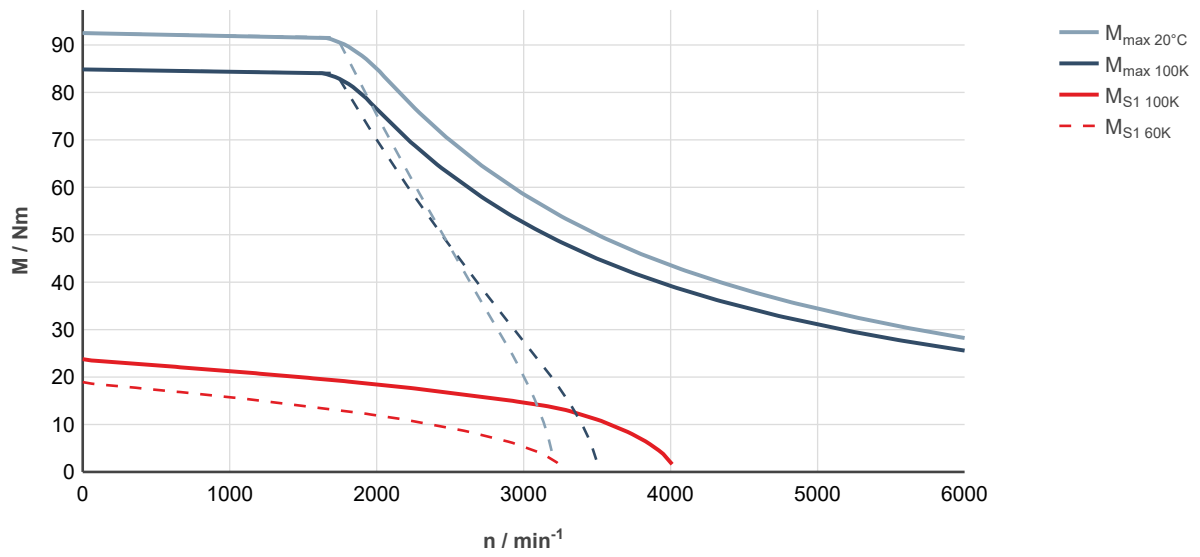

Fig. 111: MS2N07-D1BNN-___0-___-, ctrlX DRIVE, uncontrolled supply 3 × AC 400 V

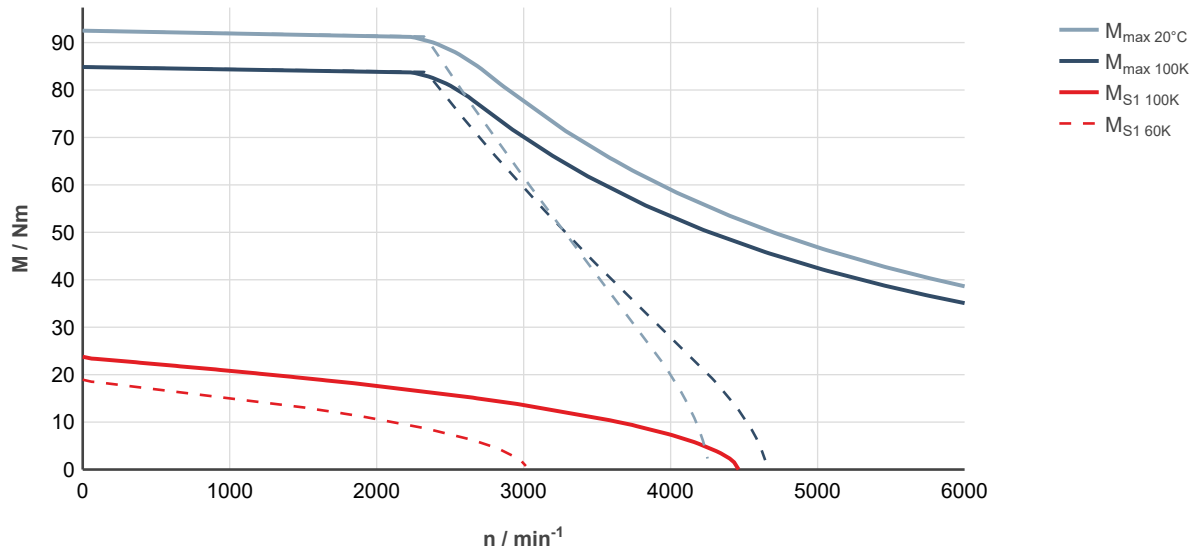

Fig. 112: MS2N07-D1BNN-___0-___-, ctrlX DRIVE, controlled supply 3 × AC 400 ... 480 V

MS2N07-E0BDN

Designation	Symbol	Unit	MS2N07-E0BDN-__0-_N	MS2N07-E0BDN-__2-_N
Standstill torque - 60K ¹⁾	M _{0 60K}	Nm	29.2	
Standstill current - 60K	I _{0 60K}	A	5.15	
Standstill torque - 100K ¹⁾	M _{0 100K}	Nm	38.2	
Standstill current - 100K	I _{0 100K}	A	6.8	
Moment of inertia of rotor ¹⁾	J _{rot}	kg*m ²	0.003	0.00341
Rated speed - 100K	n _{N 100K}	1/min	900	
Rated torque - 100K ¹⁾	M _{N 100K}	Nm	34.6	
Rated current - 100K	I _{N 100K}	A	6.2	
Rated power - 100K ¹⁾	P _{N 100K}	kW	3.26	
Maximum torque 20 °C (cold) ¹⁾	M _{max 20°C}	Nm	119.5	
Maximum torque 100K (warm) ¹⁾	M _{max 100K}	Nm	109.5	
Maximum current	I _{max(rms)}	A	24.8	
Maximum speed (electrical)	n _{max el}	1/min	2000	
Maximum speed (mechanical)	n _{max mech}	1/min	6000	
Number of pole pairs	p		5	
Torque constant at 20 °C ¹⁾	K _m	Nm/A	6.09	
Voltage constant at 20 °C ¹⁾	K _E	V/1000 min ⁻¹	370	
Winding resistance at 20 °C	R ₁₂	Ohm	3.72	
Winding inductance	L _{12,min}	mH	65.9	
Leakage capacitance of the component	C _{ab}	nF	6.95	
Thermal time constant of winding	T _{th,W}	s	60.8	
Thermal time constant of motor	T _{th,M}	min	21.7	
Mass	m _{mot}	kg	23	26
Holding brake				
Holding torque	M ₄	Nm	0	36.00
Rated voltage	U _N	V	0	24
Rated current	I _N	A	0	0.94
Maximum connection time	t ₁	ms	0	60
Maximum disconnection time	t ₂	ms	0	200

1) For tolerance details refer to [chapter 6.4 Tolerances](#)

Latest amendment: 2020-02-10

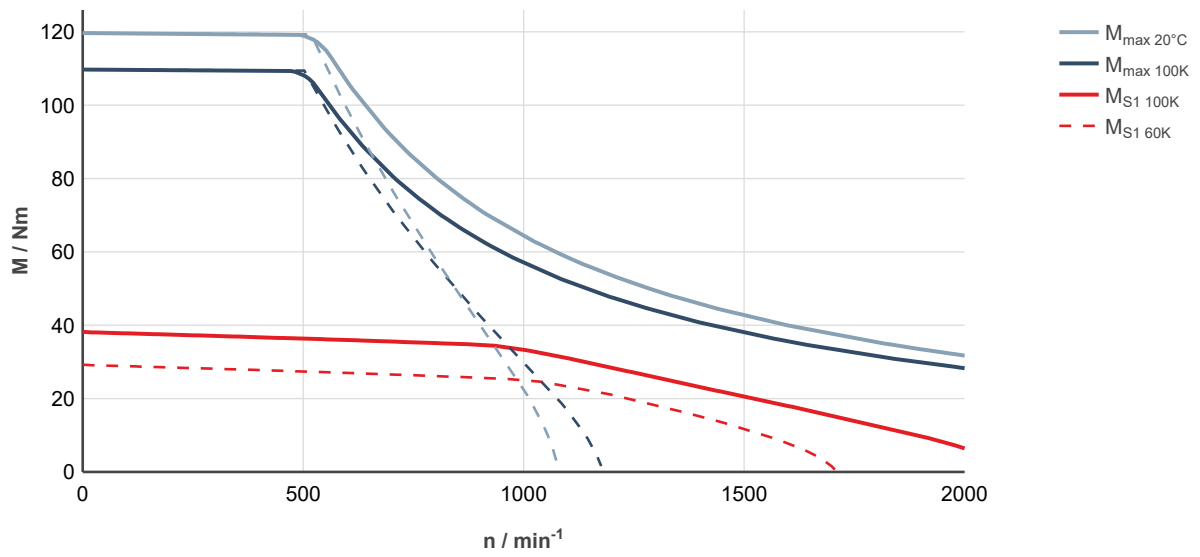

Fig. 113: MS2N07-E0BDN-___0-___-__, ctrlX DRIVE, uncontrolled supply 3 × AC 400 V

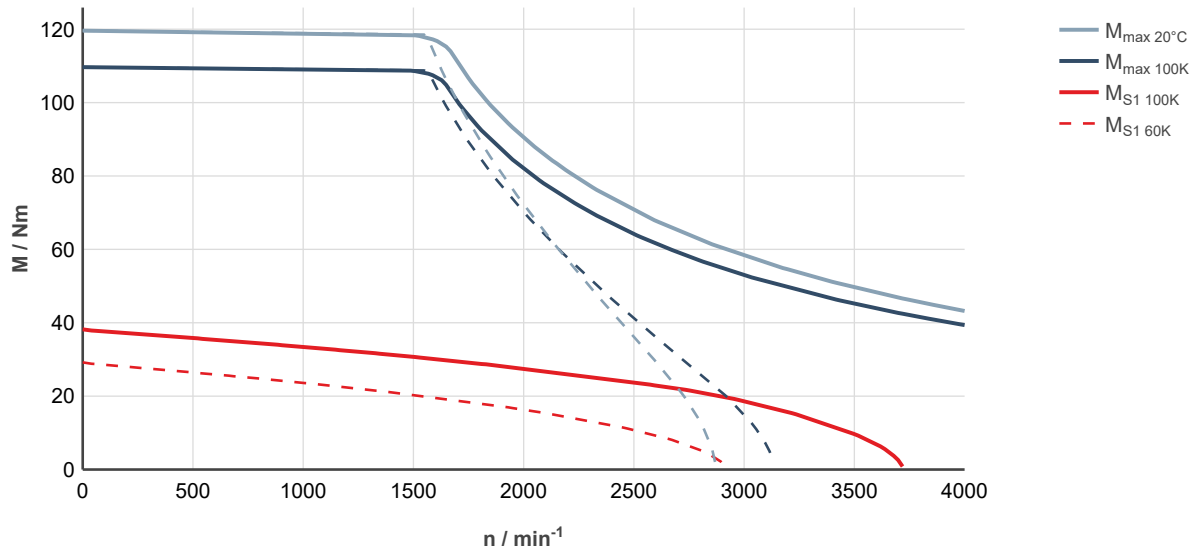

Fig. 114: MS2N07-E0BDN-___0-___-__, ctrlX DRIVE, controlled supply 3 × AC 400 ... 480 V

MS2N07-E0BHN

Designation	Symbol	Unit	MS2N07-E0BHN-__0-_N	MS2N07-E0BHN-__2-_N
Standstill torque - 60K ¹⁾	M _{0 60K}	Nm	29.2	
Standstill current - 60K	I _{0 60K}	A	10.35	
Standstill torque - 100K ¹⁾	M _{0 100K}	Nm	38.2	
Standstill current - 100K	I _{0 100K}	A	13.7	
Moment of inertia of rotor ¹⁾	J _{rot}	kg*m ²	0.003	0.00341
Rated speed - 100K	n _{N 100K}	1/min	1940	
Rated torque - 100K ¹⁾	M _{N 100K}	Nm	27.7	
Rated current - 100K	I _{N 100K}	A	10.25	
Rated power - 100K ¹⁾	P _{N 100K}	kW	5.65	
Maximum torque 20 °C (cold) ¹⁾	M _{max 20°C}	Nm	119.5	
Maximum torque 100K (warm) ¹⁾	M _{max 100K}	Nm	109.5	
Maximum current	I _{max(rms)}	A	49.5	
Maximum speed (electrical)	n _{max el}	1/min	4000	
Maximum speed (mechanical)	n _{max mech}	1/min	6000	
Number of pole pairs	p		5	
Torque constant at 20 °C ¹⁾	K _m	Nm/A	3.03	
Voltage constant at 20 °C ¹⁾	K _E	V/1000 min ⁻¹	184.3	
Winding resistance at 20 °C	R ₁₂	Ohm	0.95	
Winding inductance	L _{12,min}	mH	14.8	
Leakage capacitance of the component	C _{ab}	nF	7.1	
Thermal time constant of winding	T _{th,W}	s	60.8	
Thermal time constant of motor	T _{th,M}	min	21.7	
Mass	m _{mot}	kg	23	26
Holding brake				
Holding torque	M ₄	Nm	0	36.00
Rated voltage	U _N	V	0	24
Rated current	I _N	A	0	0.94
Maximum connection time	t ₁	ms	0	60
Maximum disconnection time	t ₂	ms	0	200

1) For tolerance details refer to [chapter 6.4 Tolerances](#)

Latest amendment: 2017-08-09

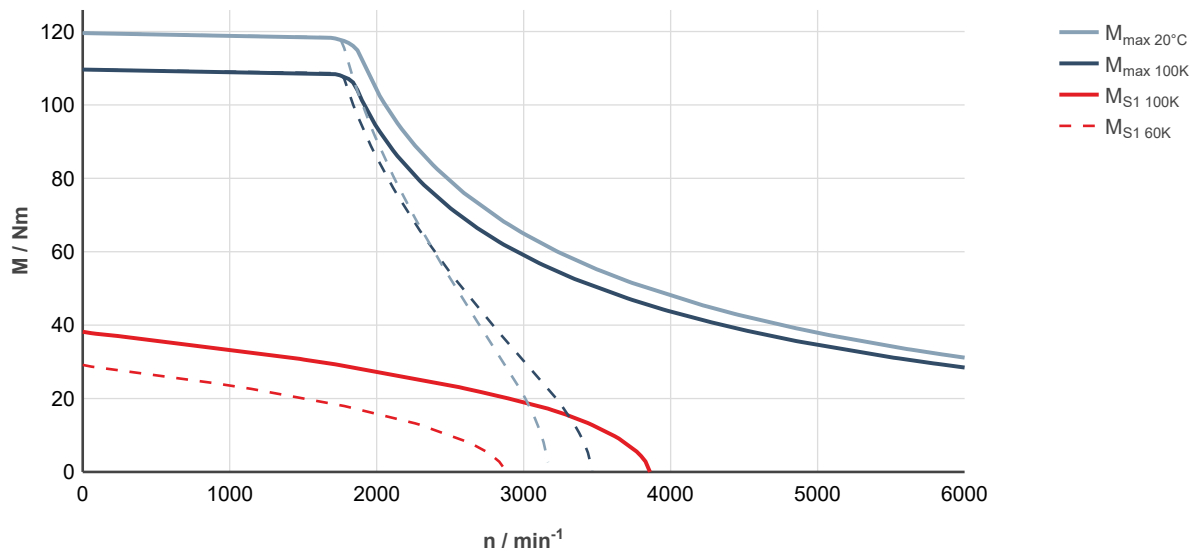

Fig. 115: MS2N07-E0BHN-___0-___-_, ctrlX DRIVE, uncontrolled supply 3 × AC 400 V

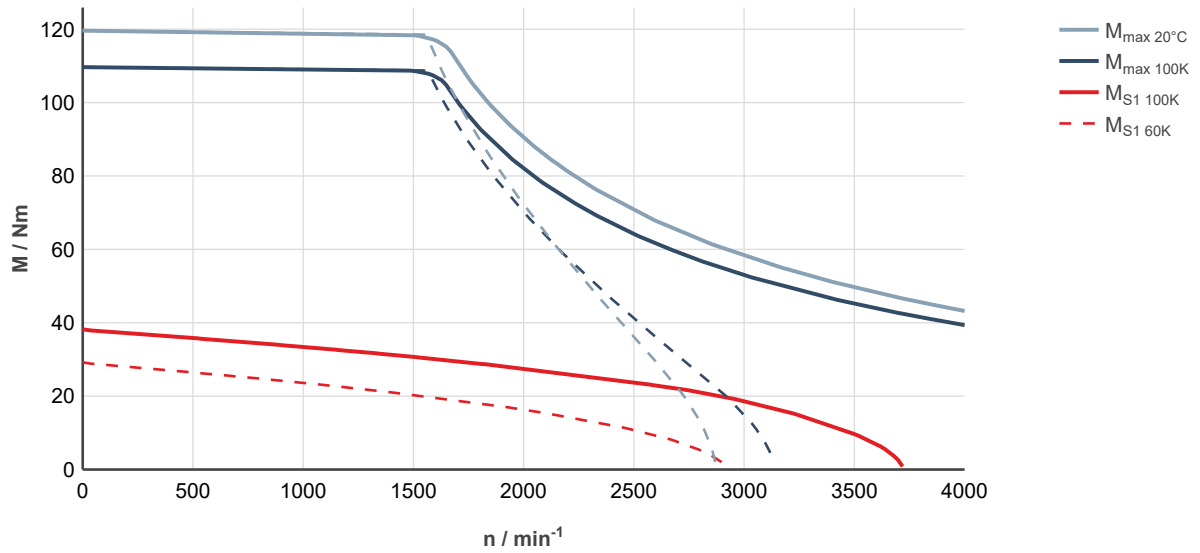

Fig. 116: MS2N07-E0BHN-___0-___-_, ctrlX DRIVE, controlled supply 3 × AC 400 ... 480 V

MS2N07-E0BNN

Designation	Symbol	Unit	MS2N07-E0BNN-__0-_N	MS2N07-E0BNN-__2-_N
Standstill torque - 60K ¹⁾	M _{0 60K}	Nm	29.2	
Standstill current - 60K	I _{0 60K}	A	15.1	
Standstill torque - 100K ¹⁾	M _{0 100K}	Nm	38.2	
Standstill current - 100K	I _{0 100K}	A	20.0	
Moment of inertia of rotor ¹⁾	J _{rot}	kg*m ²	0.003	0.00341
Rated speed - 100K	n _{N 100K}	1/min	2600	
Rated torque - 100K ¹⁾	M _{N 100K}	Nm	21.5	
Rated current - 100K	I _{N 100K}	A	11.75	
Rated power - 100K ¹⁾	P _{N 100K}	kW	5.85	
Maximum torque 20 °C (cold) ¹⁾	M _{max 20°C}	Nm	119.5	
Maximum torque 100K (warm) ¹⁾	M _{max 100K}	Nm	109.5	
Maximum current	I _{max(rms)}	A	72.7	
Maximum speed (electrical)	n _{max el}	1/min	6000	
Maximum speed (mechanical)	n _{max mech}	1/min	6000	
Number of pole pairs	p		5	
Torque constant at 20 °C ¹⁾	K _m	Nm/A	2.08	
Voltage constant at 20 °C ¹⁾	K _E	V/1000 min ⁻¹	126.2	
Winding resistance at 20 °C	R ₁₂	Ohm	0.455	
Winding inductance	L _{12,min}	mH	7.50	
Leakage capacitance of the component	C _{ab}	nF	6.11	
Thermal time constant of winding	T _{th,W}	s	60.8	
Thermal time constant of motor	T _{th,M}	min	21.7	
Mass	m _{mot}	kg	23	26
Holding brake				
Holding torque	M ₄	Nm	0	36.00
Rated voltage	U _N	V	0	24
Rated current	I _N	A	0	0.94
Maximum connection time	t ₁	ms	0	60
Maximum disconnection time	t ₂	ms	0	200
1) For tolerance details refer to chapter 6.4 Tolerances			Latest amendment: 2017-08-09	

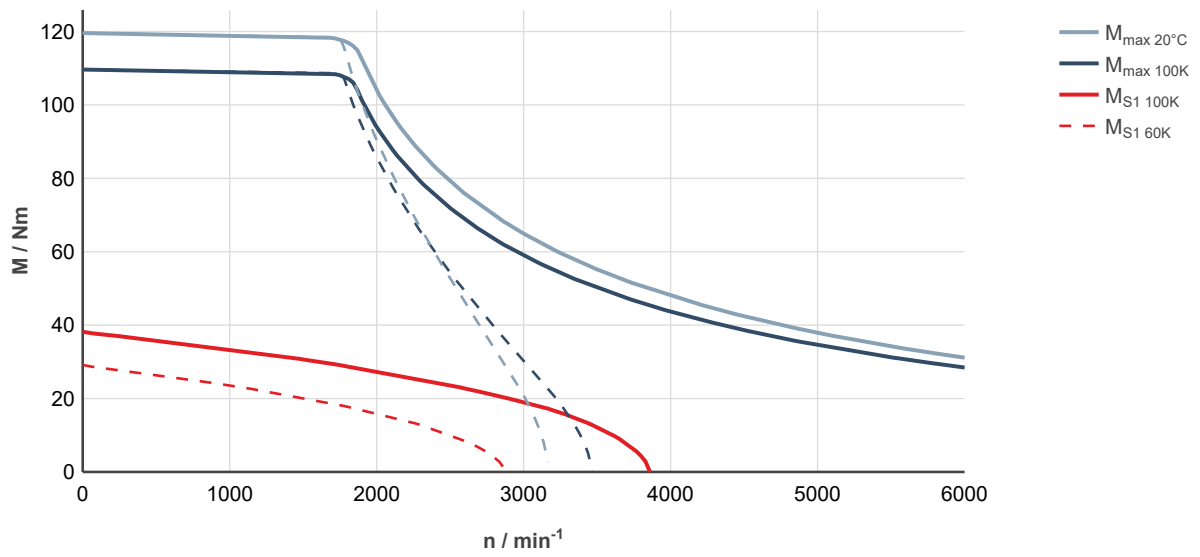

Fig. 117: MS2N07-E0BNN-___0-___-_, ctrlX DRIVE, uncontrolled supply 3 × AC 400 V

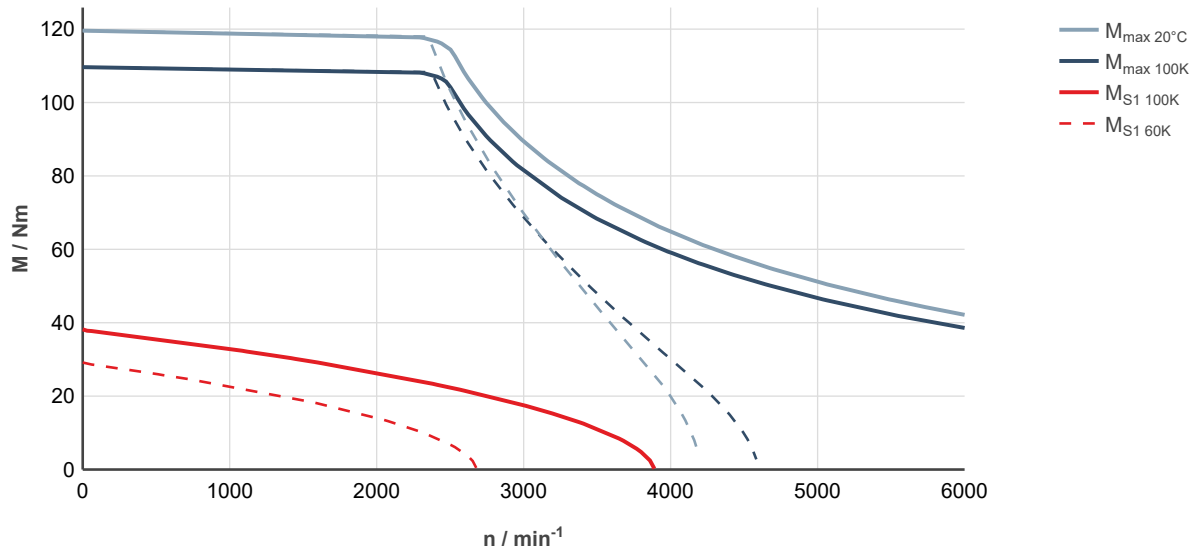

Fig. 118: MS2N07-E0BNN-___0-___-_, ctrlX DRIVE, controlled supply 3 × AC 400 ... 480 V

MS2N07-E0BQN

Designation	Symbol	Unit	MS2N07-E0BQN-__0-_N	MS2N07-E0BQN-__2-_N
Standstill torque - 60K ¹⁾	M _{0 60K}	Nm	29.2	
Standstill current - 60K	I _{0 60K}	A	19.1	
Standstill torque - 100K ¹⁾	M _{0 100K}	Nm	38.2	
Standstill current - 100K	I _{0 100K}	A	25.3	
Moment of inertia of rotor ¹⁾	J _{rot}	kg*m ²	0.003	0.00341
Rated speed - 100K	n _{N 100K}	1/min	2570	
Rated torque - 100K ¹⁾	M _{N 100K}	Nm	19.0	
Rated current - 100K	I _{N 100K}	A	13.25	
Rated power - 100K ¹⁾	P _{N 100K}	kW	5.1	
Maximum torque 20 °C (cold) ¹⁾	M _{max 20°C}	Nm	119.5	
Maximum torque 100K (warm) ¹⁾	M _{max 100K}	Nm	109.5	
Maximum current	I _{max(rms)}	A	92.3	
Maximum speed (electrical)	n _{max el}	1/min	6000	
Maximum speed (mechanical)	n _{max mech}	1/min	6000	
Number of pole pairs	p		5	
Torque constant at 20 °C ¹⁾	K _m	Nm/A	1.64	
Voltage constant at 20 °C ¹⁾	K _E	V/1000 min ⁻¹	99.3	
Winding resistance at 20 °C	R ₁₂	Ohm	0.282	
Winding inductance	L _{12,min}	mH	4.64	
Leakage capacitance of the component	C _{ab}	nF	6.21	
Thermal time constant of winding	T _{th,W}	s	60.8	
Thermal time constant of motor	T _{th,M}	min	21.7	
Mass	m _{mot}	kg	23	26
Holding brake				
Holding torque	M ₄	Nm	0	36.00
Rated voltage	U _N	V	0	24
Rated current	I _N	A	0	0.94
Maximum connection time	t ₁	ms	0	60
Maximum disconnection time	t ₂	ms	0	200
1) For tolerance details refer to chapter 6.4 Tolerances			Latest amendment:	

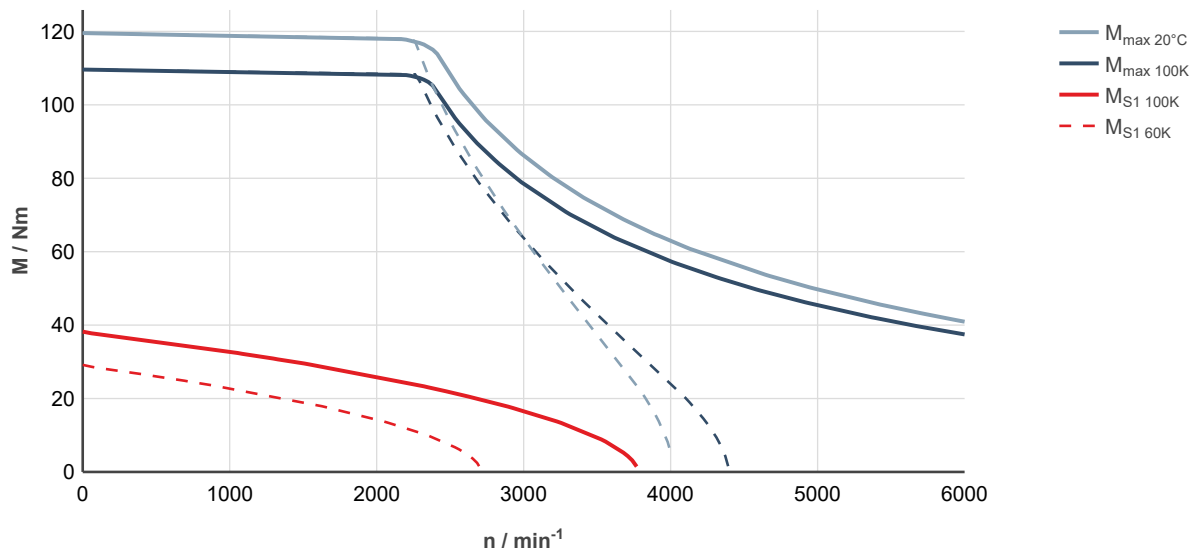

Fig. 119: MS2N07-E0BQN-___0-___-, ctrlX DRIVE, uncontrolled supply 3 × AC 400 V

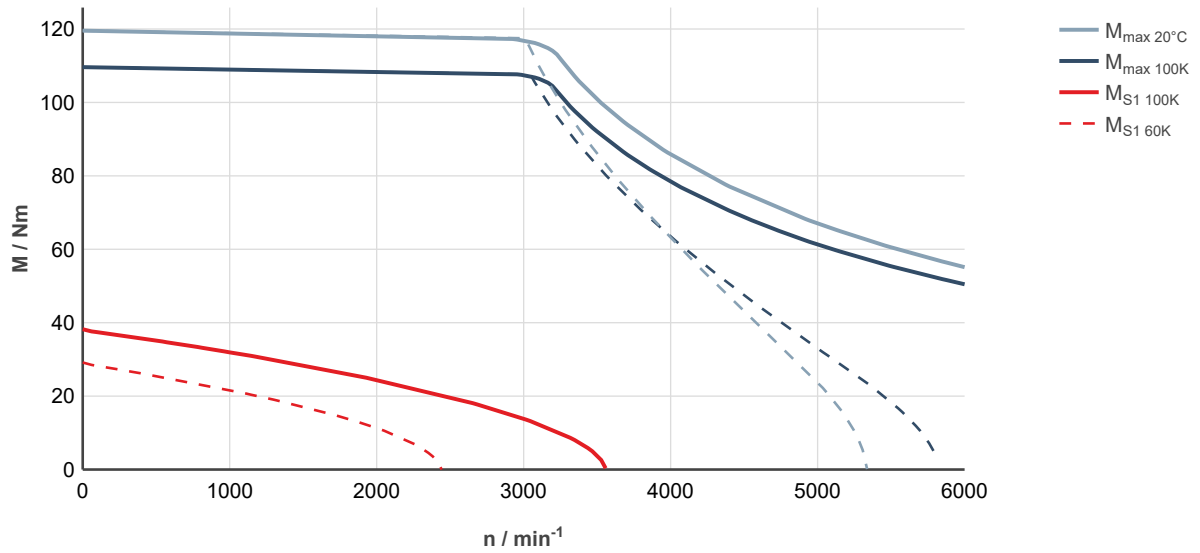

Fig. 120: MS2N07-E0BQN-___0-___-, ctrlX DRIVE, controlled supply 3 × AC 400 ... 480 V

MS2N07-E1BDN

Designation	Symbol	Unit	MS2N07-E1BDN-__0-_N	MS2N07-E1BDN-__2-_N
Standstill torque - 60K ¹⁾	M _{0 60K}	Nm	25.8	
Standstill current - 60K	I _{0 60K}	A	4.93	
Standstill torque - 100K ¹⁾	M _{0 100K}	Nm	32.2	
Standstill current - 100K	I _{0 100K}	A	6.2	
Moment of inertia of rotor ¹⁾	J _{rot}	kg*m ²	0.00752	0.00793
Rated speed - 100K	n _{N 100K}	1/min	1000	
Rated torque - 100K ¹⁾	M _{N 100K}	Nm	29.2	
Rated current - 100K	I _{N 100K}	A	5.7	
Rated power - 100K ¹⁾	P _{N 100K}	kW	3.05	
Maximum torque 20 °C (cold) ¹⁾	M _{max 20°C}	Nm	140	
Maximum torque 100K (warm) ¹⁾	M _{max 100K}	Nm	128.5	
Maximum current	I _{max(rms)}	A	29.5	
Maximum speed (electrical)	n _{max el}	1/min	2000	
Maximum speed (mechanical)	n _{max mech}	1/min	6000	
Number of pole pairs	p		5	
Torque constant at 20 °C ¹⁾	K _m	Nm/A	5.63	
Voltage constant at 20 °C ¹⁾	K _E	V/1000 min ⁻¹	341.8	
Winding resistance at 20 °C	R ₁₂	Ohm	4.2	
Winding inductance	L _{12,min}	mH	42.9	
Leakage capacitance of the component	C _{ab}	nF	5.7	
Thermal time constant of winding	T _{th,W}	s	47.5	
Thermal time constant of motor	T _{th,M}	min	21.7	
Mass	m _{mot}	kg	23	26
Holding brake				
Holding torque	M ₄	Nm	0	36.00
Rated voltage	U _N	V	0	24
Rated current	I _N	A	0	0.94
Maximum connection time	t ₁	ms	0	60
Maximum disconnection time	t ₂	ms	0	200

1) For tolerance details refer to [chapter 6.4 Tolerances](#)

Latest amendment: 2020-02-10

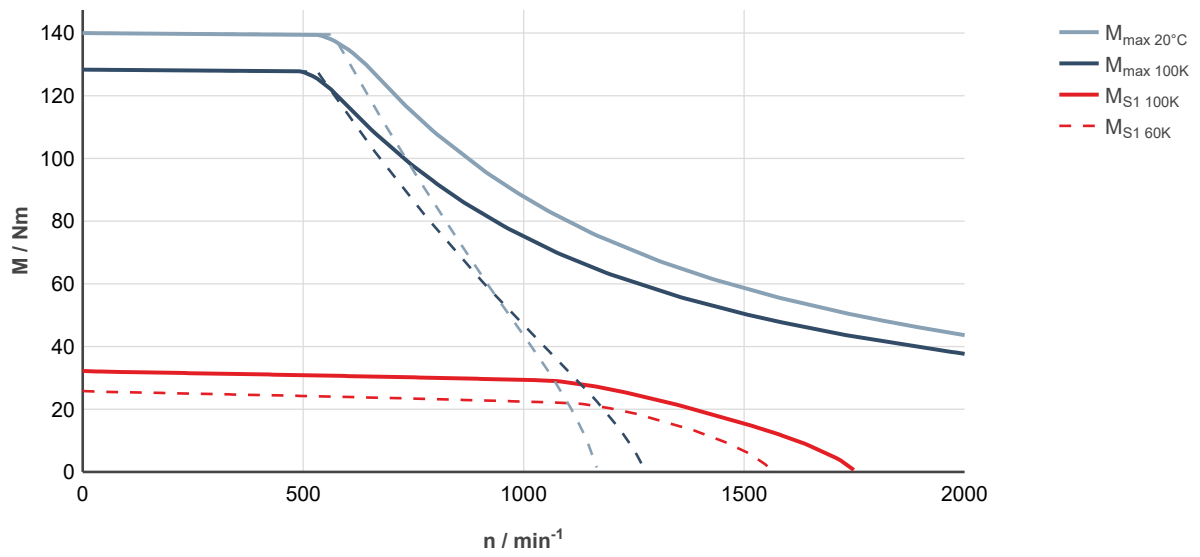

Fig. 121: MS2N07-E1BDN-___0-___-_, ctrlX DRIVE, uncontrolled supply 3 × AC 400 V

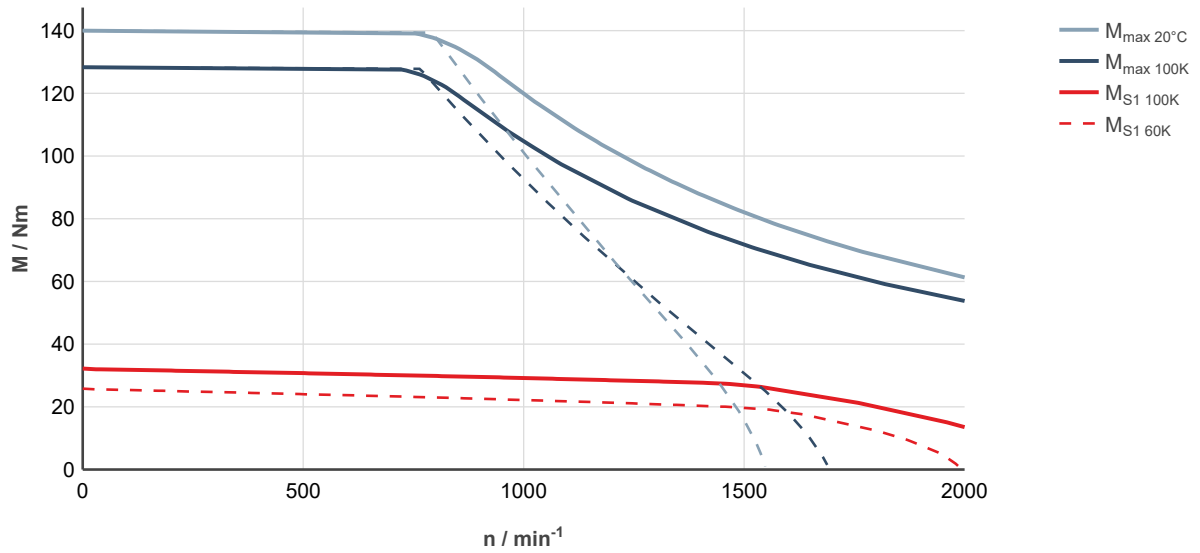

Fig. 122: MS2N07-E1BDN-___0-___-_, ctrlX DRIVE, controlled supply 3 × AC 400 ... 480 V

MS2N07-E1BHN

Designation	Symbol	Unit	MS2N07-E1BHN-__0-_N	MS2N07-E1BHN-__2-_N
Standstill torque - 60K ¹⁾	M _{0 60K}	Nm	25.8	
Standstill current - 60K	I _{0 60K}	A	9	
Standstill torque - 100K ¹⁾	M _{0 100K}	Nm	32.2	
Standstill current - 100K	I _{0 100K}	A	11.3	
Moment of inertia of rotor ¹⁾	J _{rot}	kg*m ²	0.00752	0.00793
Rated speed - 100K	n _{N 100K}	1/min	2000	
Rated torque - 100K ¹⁾	M _{N 100K}	Nm	23.5	
Rated current - 100K	I _{N 100K}	A	8.55	
Rated power - 100K ¹⁾	P _{N 100K}	kW	4.93	
Maximum torque 20 °C (cold) ¹⁾	M _{max 20°C}	Nm	140	
Maximum torque 100K (warm) ¹⁾	M _{max 100K}	Nm	128.5	
Maximum current	I _{max(rms)}	A	54.1	
Maximum speed (electrical)	n _{max el}	1/min	4000	
Maximum speed (mechanical)	n _{max mech}	1/min	6000	
Number of pole pairs	p		5	
Torque constant at 20 °C ¹⁾	K _m	Nm/A	3.08	
Voltage constant at 20 °C ¹⁾	K _E	V/1000 min ⁻¹	187	
Winding resistance at 20 °C	R ₁₂	Ohm	1.31	
Winding inductance	L _{12,min}	mH	12.1	
Leakage capacitance of the component	C _{ab}	nF	4.77	
Thermal time constant of winding	T _{th,W}	s	47.5	
Thermal time constant of motor	T _{th,M}	min	21.7	
Mass	m _{mot}	kg	23	26
Holding brake				
Holding torque	M ₄	Nm	0	36.00
Rated voltage	U _N	V	0	24
Rated current	I _N	A	0	0.94
Maximum connection time	t ₁	ms	0	60
Maximum disconnection time	t ₂	ms	0	200
1) For tolerance details refer to chapter 6.4 Tolerances			Latest amendment: 2017-03-22	

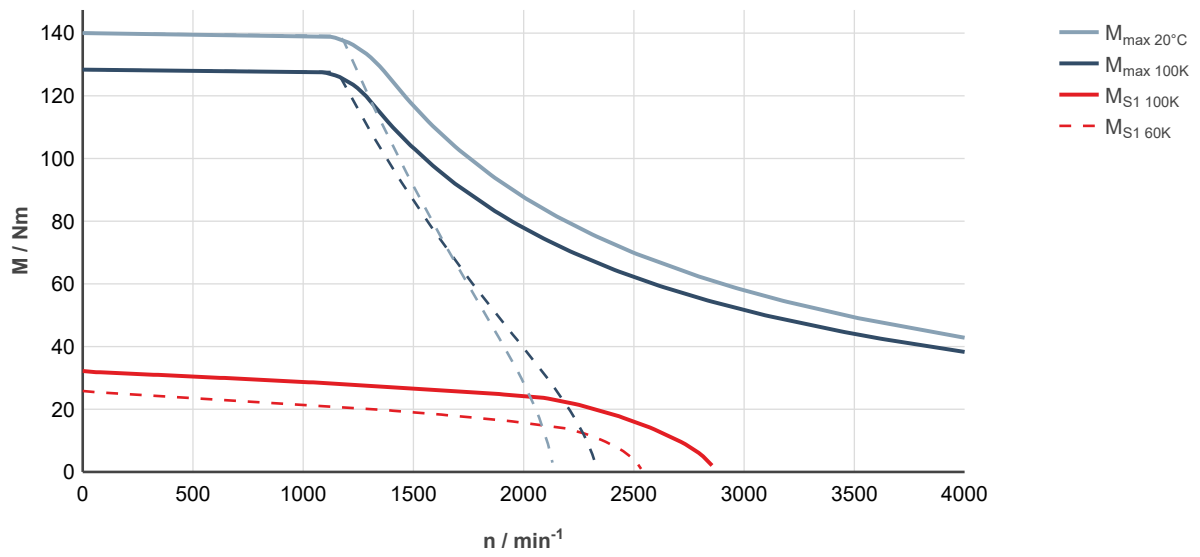

Fig. 123: MS2N07-E1BHN-___0-___-__, ctrlX DRIVE, uncontrolled supply 3 × AC 400 V

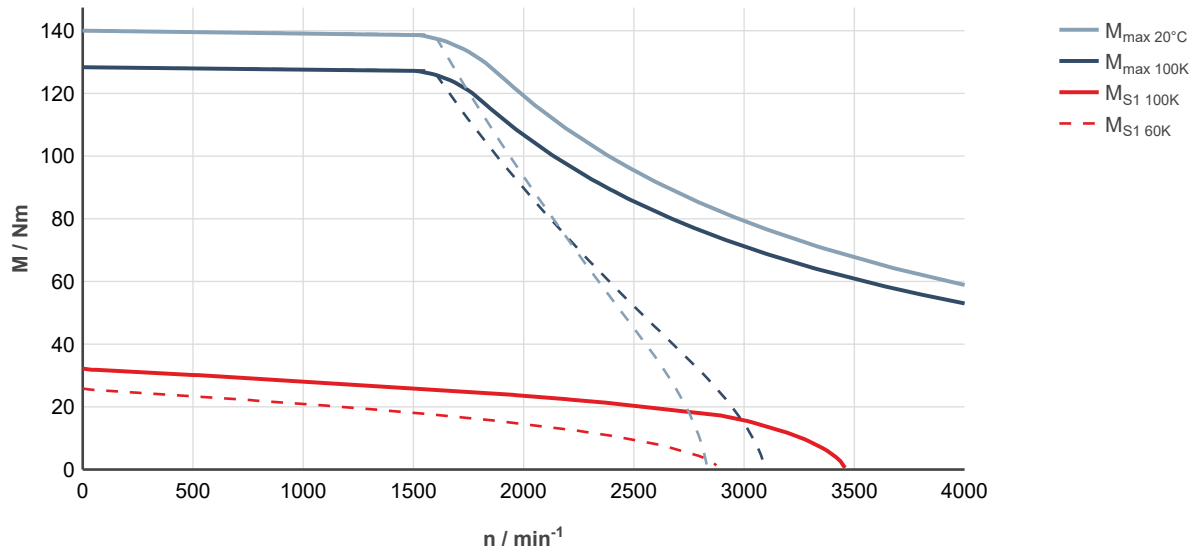

Fig. 124: MS2N07-E1BHN-___0-___-__, ctrlX DRIVE, controlled supply 3 × AC 400 ... 480 V

MS2N07-E1BNN

Designation	Symbol	Unit	MS2N07-E1BNN-__0-_N	MS2N07-E1BNN-__2-_N
Standstill torque - 60K ¹⁾	M _{0 60K}	Nm	25.8	
Standstill current - 60K	I _{0 60K}	A	14.1	
Standstill torque - 100K ¹⁾	M _{0 100K}	Nm	32.2	
Standstill current - 100K	I _{0 100K}	A	17.7	
Moment of inertia of rotor ¹⁾	J _{rot}	kg*m ²	0.00752	0.00793
Rated speed - 100K	n _{N 100K}	1/min	2500	
Rated torque - 100K ¹⁾	M _{N 100K}	Nm	15.6	
Rated current - 100K	I _{N 100K}	A	9.15	
Rated power - 100K ¹⁾	P _{N 100K}	kW	4.08	
Maximum torque 20 °C (cold) ¹⁾	M _{max 20°C}	Nm	140	
Maximum torque 100K (warm) ¹⁾	M _{max 100K}	Nm	128.5	
Maximum current	I _{max(rms)}	A	85.4	
Maximum speed (electrical)	n _{max el}	1/min	6000	
Maximum speed (mechanical)	n _{max mech}	1/min	6000	
Number of pole pairs	p		5	
Torque constant at 20 °C ¹⁾	K _m	Nm/A	1.96	
Voltage constant at 20 °C ¹⁾	K _E	V/1000 min ⁻¹	119.0	
Winding resistance at 20 °C	R ₁₂	Ohm	0.532	
Winding inductance	L _{12,min}	mH	5.12	
Leakage capacitance of the component	C _{ab}	nF	4.65	
Thermal time constant of winding	T _{th,W}	s	47.5	
Thermal time constant of motor	T _{th,M}	min	21.7	
Mass	m _{mot}	kg	23	26
Holding brake				
Holding torque	M ₄	Nm	0	36.00
Rated voltage	U _N	V	0	24
Rated current	I _N	A	0	0.94
Maximum connection time	t ₁	ms	0	60
Maximum disconnection time	t ₂	ms	0	200

1) For tolerance details refer to [chapter 6.4 Tolerances](#)

Latest amendment: 2017-03-02

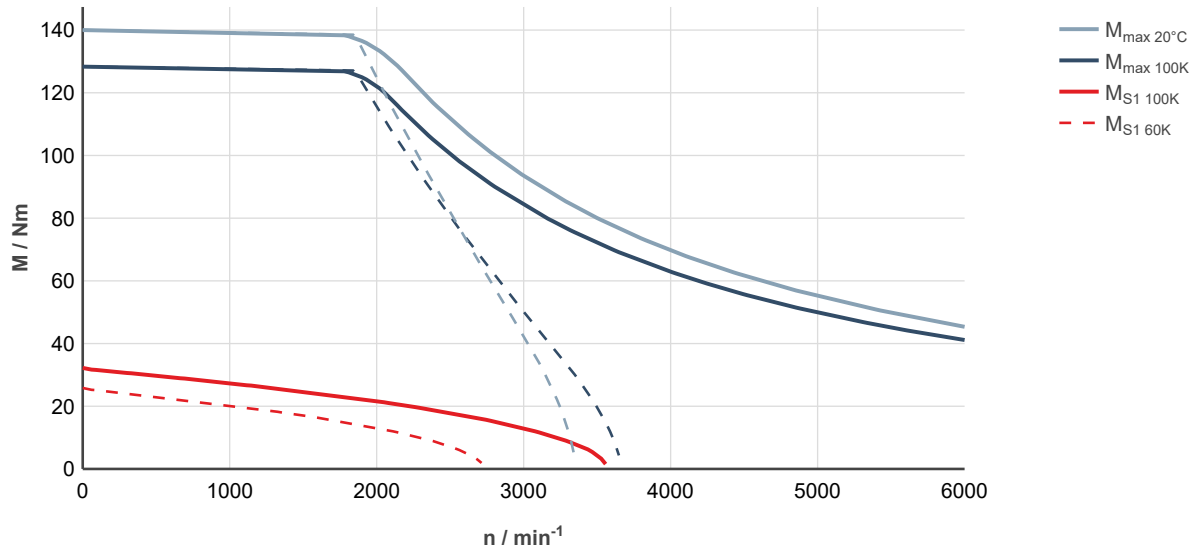

Fig. 125: MS2N07-E1BNN-___0-___-_, ctrlX DRIVE, uncontrolled supply 3 × AC 400 V

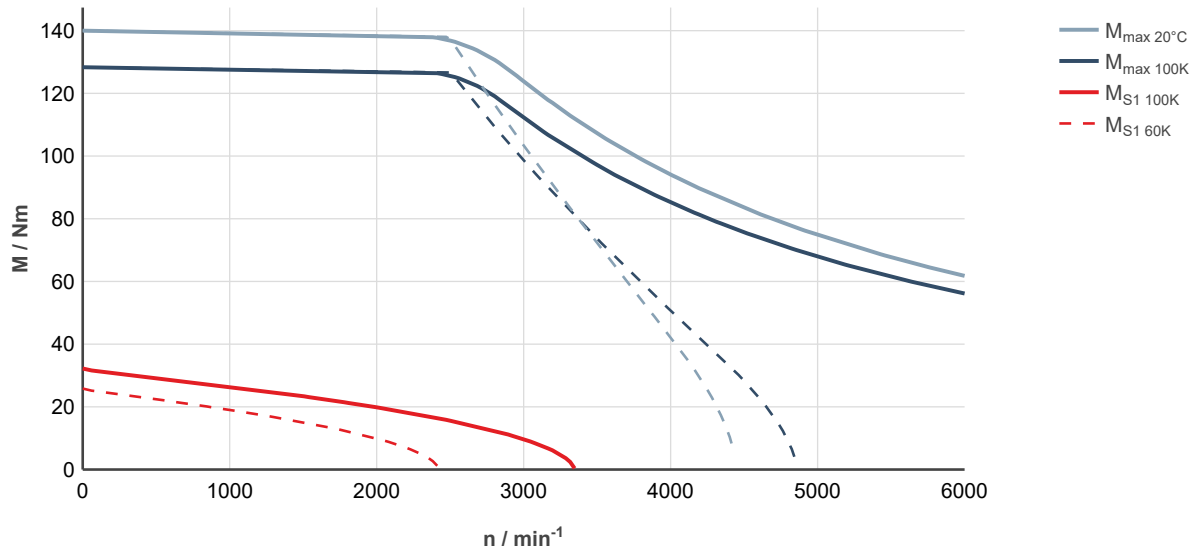

Fig. 126: MS2N07-E1BNN-___0-___-_, ctrlX DRIVE, controlled supply 3 × AC 400 ... 480 V

7.5.2 Forced ventilation

MS2N07-C0BNA/B

Designation	Symbol	Unit	MS2N07- C0BNA-__0- _N	MS2N07- C0BNA-__1- _N	MS2N07- C0BNB-__0- _N	MS2N07- C0BNB-__1- _N
Standstill torque - 100K ¹⁾	M _{0 100K}	Nm	19.8			
Standstill current - 100K	I _{0 100K}	A	11			
Moment of inertia of rotor ¹⁾	J _{rot}	kg*m ²	0.0012	0.00146	0.0012	0.00146
Rated speed - 100K	n _{N 100K}	1/min	2490			
Rated torque - 100K ¹⁾	M _{N 100K}	Nm	16.3			
Rated current - 100K	I _{N 100K}	A	9.15			
Rated power - 100K ¹⁾	P _{N 100K}	kW	4.25			
Maximum torque 20 °C (cold) ¹⁾	M _{max 20°C}	Nm	38.8			
Maximum torque 100K (warm) ¹⁾	M _{max 100K}	Nm	35.7			
Maximum current	I _{max(rms)}	A	24.8			
Maximum speed (electrical)	n _{max el}	1/min	6000			
Maximum speed (mechanical)	n _{max mech}	1/min	6000			
Number of pole pairs	p		5			
Torque constant at 20 °C ¹⁾	K _m	Nm/A	2.01			
Voltage constant at 20 °C ¹⁾	K _E	V/1000 min ⁻¹	122.0			
Winding resistance at 20 °C	R ₁₂	Ohm	1.58			
Winding inductance	L _{12_min}	mH	23.2			
Leakage capacitance of the component	C _{ab}	nF	2.42			
Thermal time constant of winding	T _{th_W}	s	39.4			
Thermal time constant of motor	T _{th_M}	min	9.0			
Mass	m _{mot}	kg	14.5	16.5	14.5	16.5
Holding brake						
Holding torque	M ₄	Nm	0	20.00	0	20.00
Rated voltage	U _N	V	0	24	0	24
Rated current	I _N	A	0	0.78	0	0.78
Maximum connection time	t ₁	ms	0	40	0	40
Maximum disconnection time	t ₂	ms	0	100	0	100
Fan data						
Rated voltage	U _N	V	230		115	
Rated current	I _N	A	0.20/0.18		0.45	
Frequency	f _N	Hz	50/60		60	
1) For tolerance details refer to chapter 6.4 Tolerances			Latest amendment: 2017-07-04			

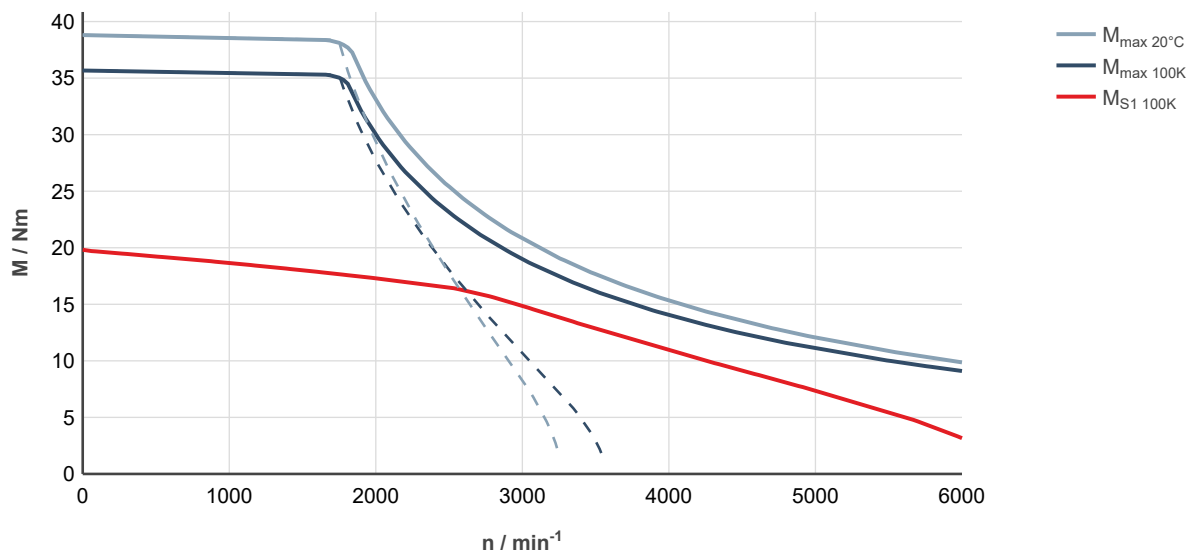

Fig. 127: MS2N07-C0BNA-___0-___-_, ctrlX DRIVE, uncontrolled supply 3 × AC 400 V

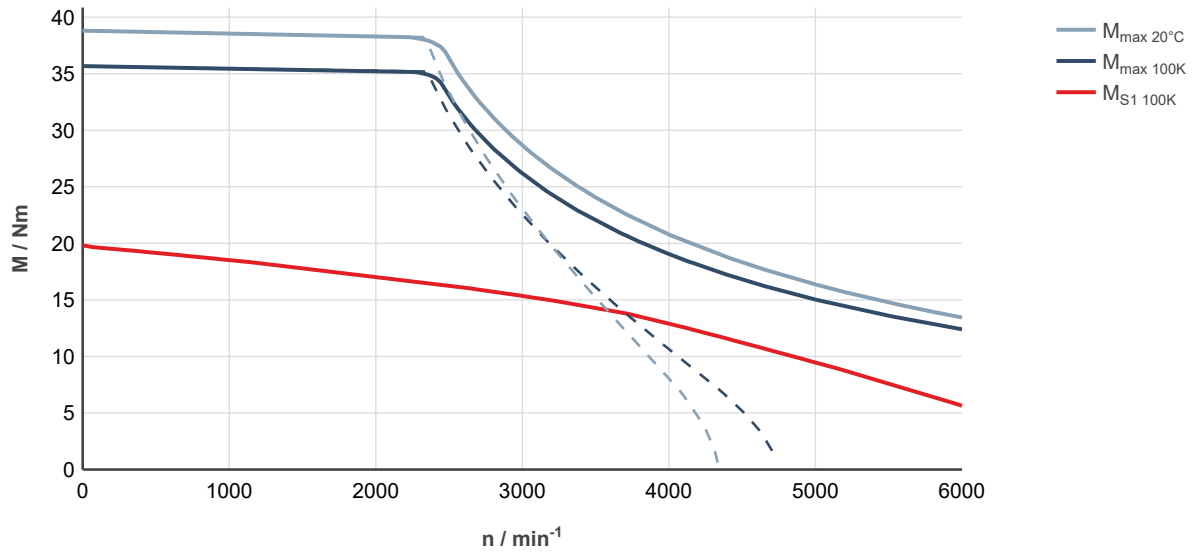

Fig. 128: MS2N07-C0BNA-___0-___-_, ctrlX DRIVE, controlled supply 3 × AC 400 ... 480 V

MS2N07-C0BQA/B

Designation	Symbol	Unit	MS2N07- C0BQA-__0- _N	MS2N07- C0BQA-__1- _N	MS2N07- C0BQB-__0- _N	MS2N07- C0BQB-__1- _N
Standstill torque - 100K ¹⁾	M _{0 100K}	Nm	19.8			
Standstill current - 100K	I _{0 100K}	A	15.8			
Moment of inertia of rotor ¹⁾	J _{rot}	kg*m ²	0.0012	0.00146	0.0012	0.00146
Rated speed - 100K	n _{N 100K}	1/min	3900			
Rated torque - 100K ¹⁾	M _{N 100K}	Nm	12.45			
Rated current - 100K	I _{N 100K}	A	10.2			
Rated power - 100K ¹⁾	P _{N 100K}	kW	5.1			
Maximum torque 20 °C (cold) ¹⁾	M _{max 20°C}	Nm	38.8			
Maximum torque 100K (warm) ¹⁾	M _{max 100K}	Nm	35.7			
Maximum current	I _{max(rms)}	A	36.4			
Maximum speed (electrical)	n _{max el}	1/min	6000			
Maximum speed (mechanical)	n _{max mech}	1/min	6000			
Number of pole pairs	p		5			
Torque constant at 20 °C ¹⁾	K _m	Nm/A	1.37			
Voltage constant at 20 °C ¹⁾	K _E	V/1000 min ⁻¹	83.1			
Winding resistance at 20 °C	R ₁₂	Ohm	0.776			
Winding inductance	L _{12_min}	mH	10.5			
Leakage capacitance of the component	C _{ab}	nF	2.2			
Thermal time constant of winding	T _{th_W}	s	39.4			
Thermal time constant of motor	T _{th_M}	min	9.0			
Mass	m _{mot}	kg	14.5	16.5	14.5	16.5
Holding brake						
Holding torque	M ₄	Nm	0	20.00	0	20.00
Rated voltage	U _N	V	0	24	0	24
Rated current	I _N	A	0	0.78	0	0.78
Maximum connection time	t ₁	ms	0	40	0	40
Maximum disconnection time	t ₂	ms	0	100	0	100
Fan data						
Rated voltage	U _N	V	230		115	
Rated current	I _N	A	0.20/0.18		0.45	
Frequency	f _N	Hz	50/60		60	
1) For tolerance details refer to chapter 6.4 Tolerances			Latest amendment: 2017-08-09			

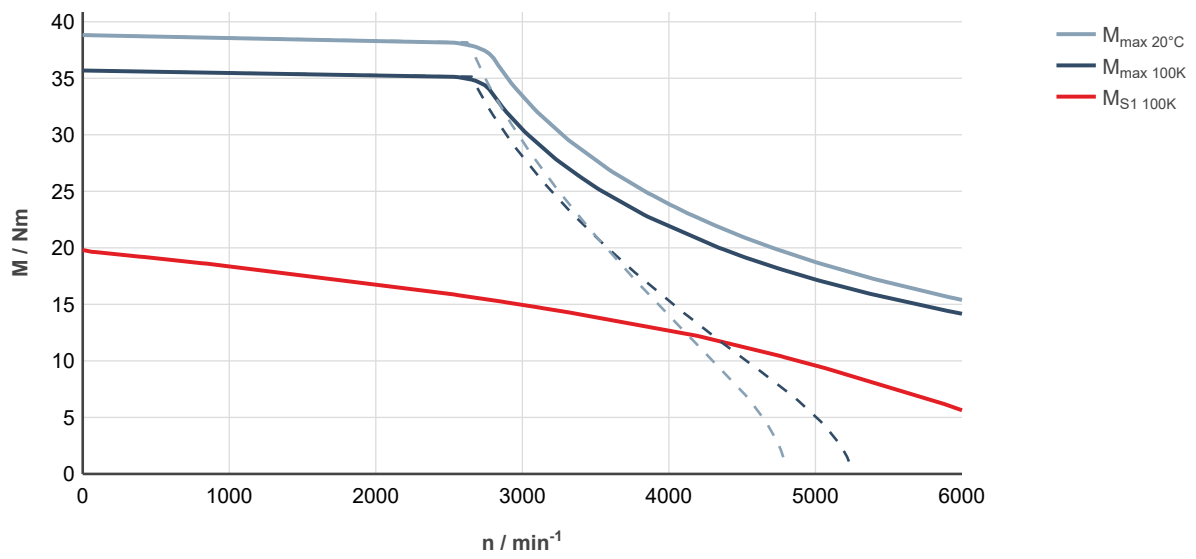

Fig. 129: MS2N07-C0BQA-___0-___-_, ctrlX DRIVE, uncontrolled supply 3 × AC 400 V

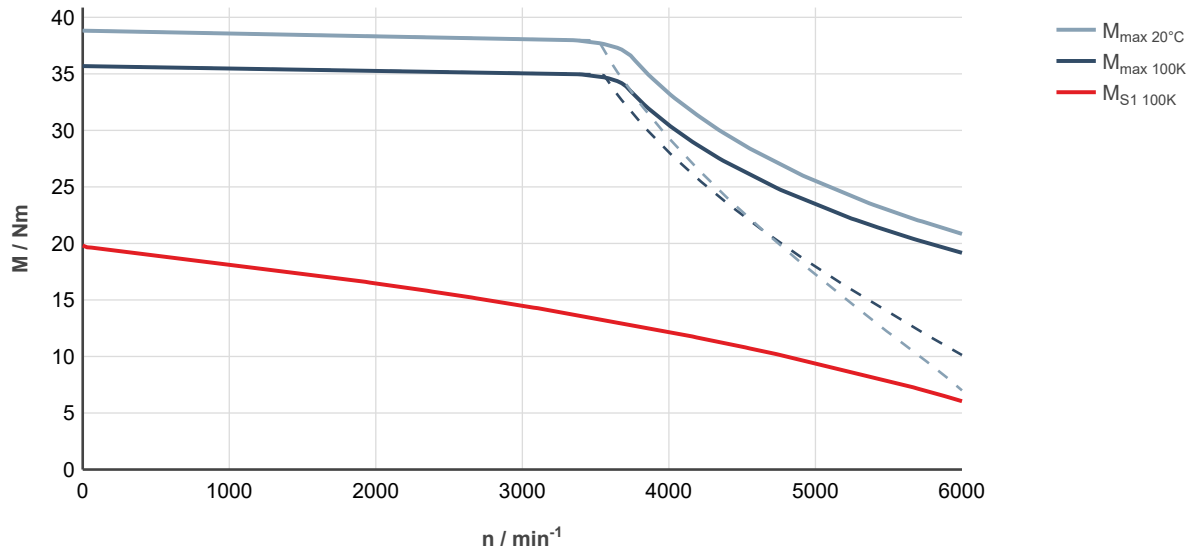

Fig. 130: MS2N07-C0BQA-___0-___-_, ctrlX DRIVE, controlled supply 3 × AC 400 ... 480 V

MS2N07-C1BNA/B

Designation	Symbol	Unit	MS2N07- C1BNA-__0- _N	MS2N07- C1BNA-__1- _N	MS2N07- C1BNB-__0- _N	MS2N07- C1BNB-__1- _N
Standstill torque - 100K ¹⁾	$M_{0\ 100K}$	Nm	18.0			
Standstill current - 100K	$I_{0\ 100K}$	A	10.4			
Moment of inertia of rotor ¹⁾	J_{rot}	kg*m ²	0.00305	0.00331	0.00305	0.00331
Rated speed - 100K	$n_{N\ 100K}$	1/min	3000			
Rated torque - 100K ¹⁾	$M_{N\ 100K}$	Nm	13.65			
Rated current - 100K	$I_{N\ 100K}$	A	8.15			
Rated power - 100K ¹⁾	$P_{N\ 100K}$	kW	4.29			
Maximum torque 20 °C (cold) ¹⁾	$M_{max\ 20°C}$	Nm	46.0			
Maximum torque 100K (warm) ¹⁾	$M_{max\ 100K}$	Nm	42.2			
Maximum current	$I_{max(rms)}$	A	29.5			
Maximum speed (electrical)	$n_{max\ el}$	1/min	6000			
Maximum speed (mechanical)	$n_{max\ mech}$	1/min	6000			
Number of pole pairs	p		5			
Torque constant at 20 °C ¹⁾	K_m	Nm/A	1.88			
Voltage constant at 20 °C ¹⁾	K_E	V/1000 min ⁻¹	114.0			
Winding resistance at 20 °C	R_{12}	Ohm	1.8			
Winding inductance	L_{12_min}	mH	15.2			
Leakage capacitance of the component	C_{ab}	nF	1.85			
Thermal time constant of winding	T_{th_W}	s	34.5			
Thermal time constant of motor	T_{th_M}	min	9.0			
Mass	m_{mot}	kg	14.5	16.5	14.5	16.5
Holding brake						
Holding torque	M_4	Nm	0	20.00	0	20.00
Rated voltage	U_N	V	0	24	0	24
Rated current	I_N	A	0	0.78	0	0.78
Maximum connection time	t_1	ms	0	40	0	40
Maximum disconnection time	t_2	ms	0	100	0	100
Fan data						
Rated voltage	U_N	V	230		115	
Rated current	I_N	A	0.20/0.18		0.45	
Frequency	f_N	Hz	50/60		60	
1) For tolerance details refer to chapter 6.4 Tolerances			Latest amendment: 2020-06-03			

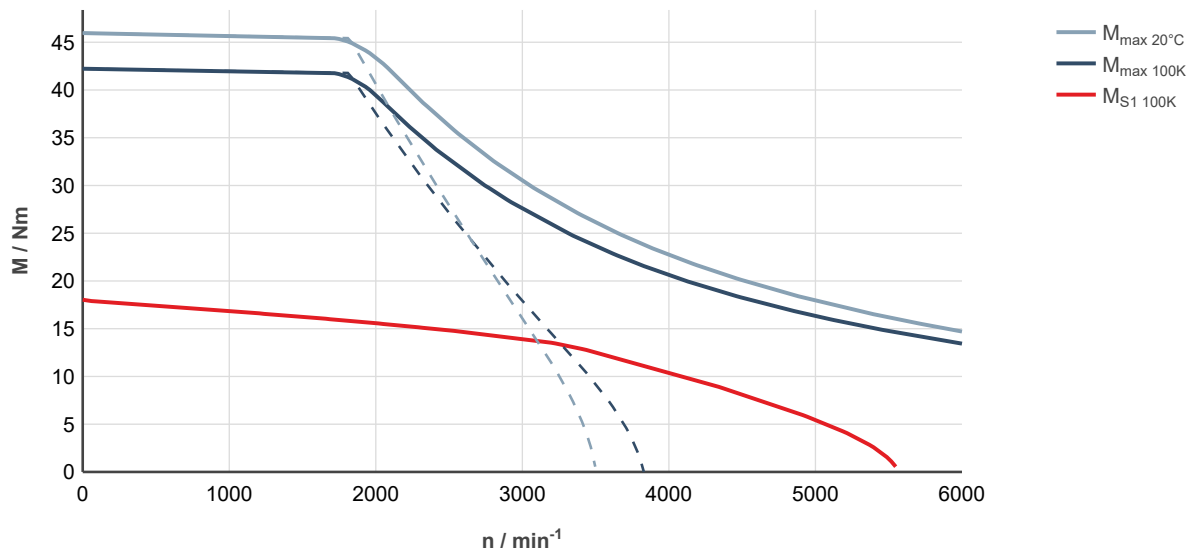

Fig. 131: MS2N07-C1BNA-___0-___-_, ctrlX DRIVE, uncontrolled supply 3 × AC 400 V

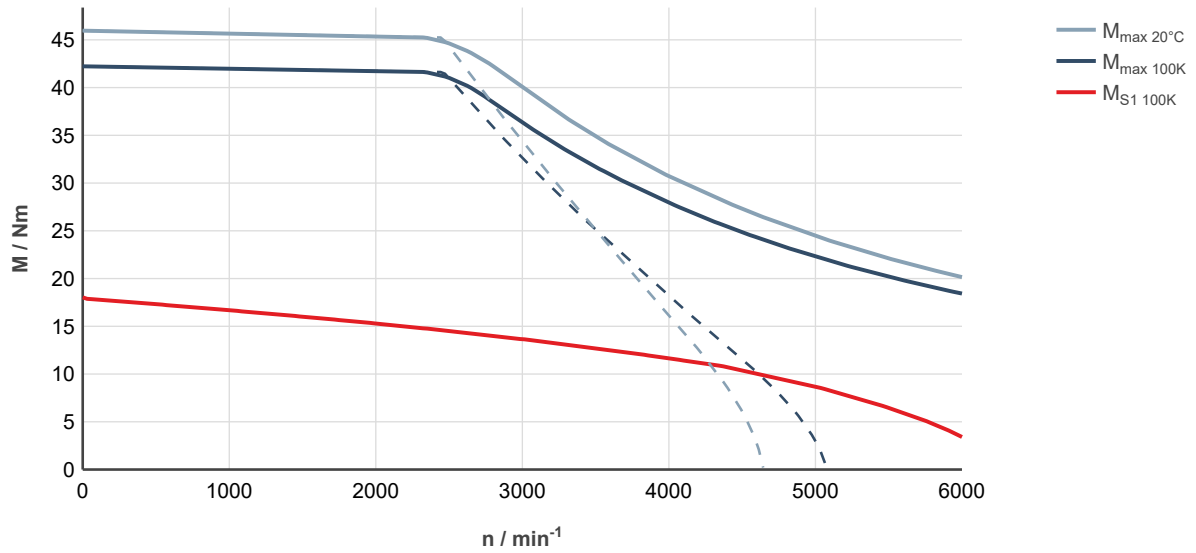

Fig. 132: MS2N07-C1BNA-___0-___-_, ctrlX DRIVE, controlled supply 3 × AC 400 ... 480 V

MS2N07-C1BRA/B

Designation	Symbol	Unit	MS2N07- C1BRA-__0- _N	MS2N07- C1BRA-__1- _N	MS2N07- C1BRB-__0- _N	MS2N07- C1BRB-__1- _N
Standstill torque - 100K ¹⁾	$M_{0\ 100K}$	Nm	18.0			
Standstill current - 100K	$I_{0\ 100K}$	A	14.9			
Moment of inertia of rotor ¹⁾	J_{rot}	kg*m ²	0.00305	0.00331	0.00305	0.00331
Rated speed - 100K	$n_{N\ 100K}$	1/min	4100			
Rated torque - 100K ¹⁾	$M_{N\ 100K}$	Nm	9.65			
Rated current - 100K	$I_{N\ 100K}$	A	8.55			
Rated power - 100K ¹⁾	$P_{N\ 100K}$	kW	4.14			
Maximum torque 20 °C (cold) ¹⁾	$M_{max\ 20°C}$	Nm	46.0			
Maximum torque 100K (warm) ¹⁾	$M_{max\ 100K}$	Nm	42.2			
Maximum current	$I_{max(rms)}$	A	42.7			
Maximum speed (electrical)	$n_{max\ el}$	1/min	6000			
Maximum speed (mechanical)	$n_{max\ mech}$	1/min	6000			
Number of pole pairs	p		5			
Torque constant at 20 °C ¹⁾	K_m	Nm/A	1.3			
Voltage constant at 20 °C ¹⁾	K_E	V/1000 min ⁻¹	78.7			
Winding resistance at 20 °C	R_{12}	Ohm	0.895			
Winding inductance	L_{12_min}	mH	7.28			
Leakage capacitance of the component	C_{ab}	nF	1.65			
Thermal time constant of winding	T_{th_W}	s	34.5			
Thermal time constant of motor	T_{th_M}	min	9.0			
Mass	m_{mot}	kg	14.5	16.5	14.5	16.5
Holding brake						
Holding torque	M_4	Nm	0	20.00	0	20.00
Rated voltage	U_N	V	0	24	0	24
Rated current	I_N	A	0	0.78	0	0.78
Maximum connection time	t_1	ms	0	40	0	40
Maximum disconnection time	t_2	ms	0	100	0	100
Fan data						
Rated voltage	U_N	V	230		115	
Rated current	I_N	A	0.20/0.18		0.45	
Frequency	f_N	Hz	50/60		60	
1) For tolerance details refer to chapter 6.4 Tolerances			Latest amendment: 2017-08-09			

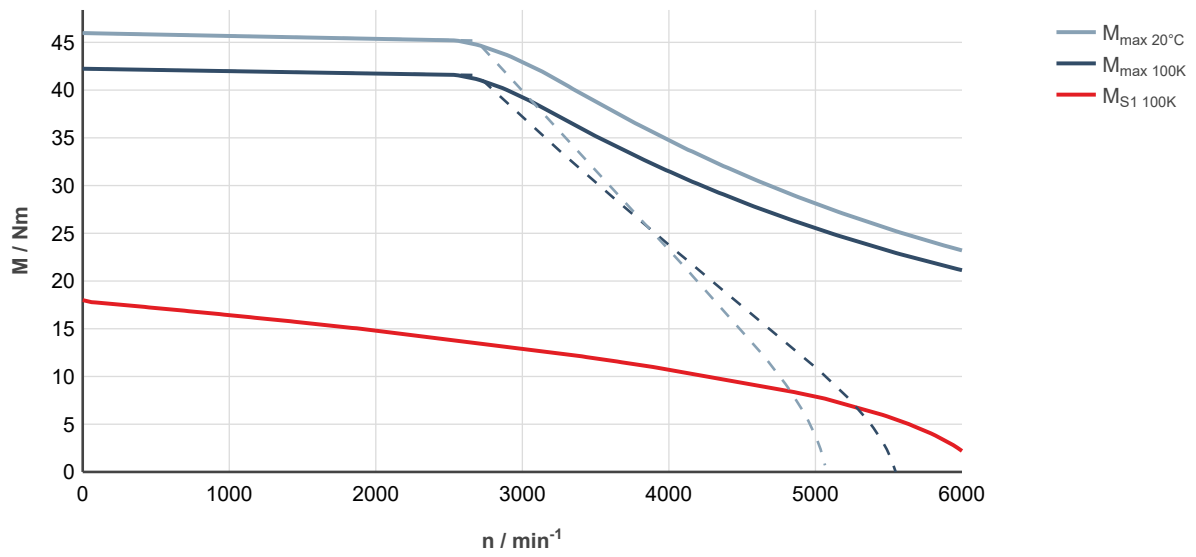

Fig. 133: MS2N07-C1BRA-___0-___-__, ctrlX DRIVE, uncontrolled supply 3 × AC 400 V

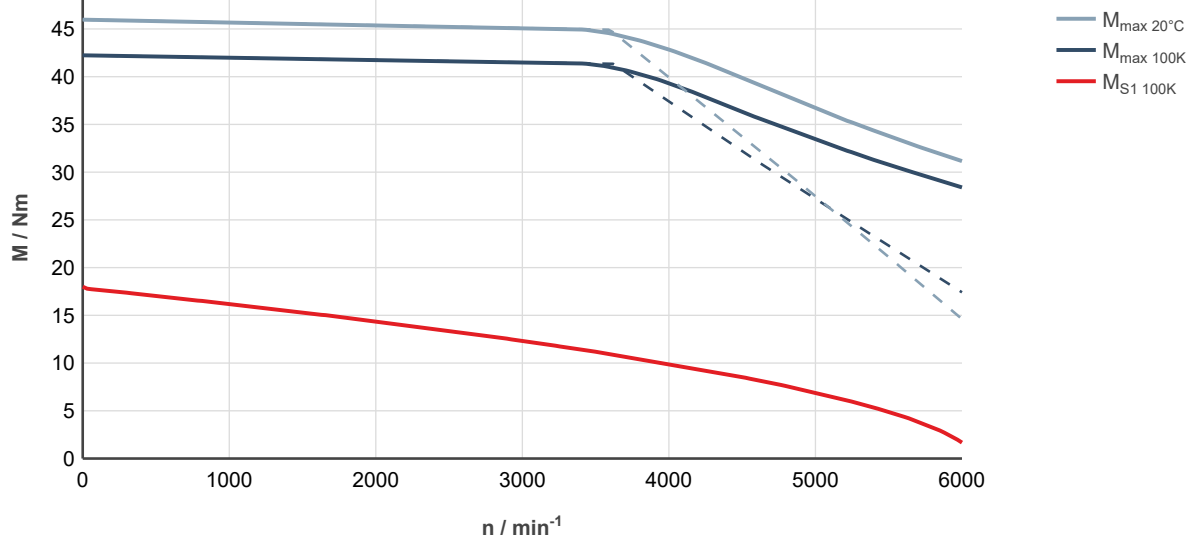

Fig. 134: MS2N07-C1BRA-___0-___-__, ctrlX DRIVE, controlled supply 3 × AC 400 ... 480 V

MS2N07-D0BFA/B

Designation	Symbol	Unit	MS2N07- D0BFA-__0- _N	MS2N07- D0BFA-__2- _N	MS2N07- D0BFB-__0- _N	MS2N07- D0BFB-__2- _N
Standstill torque - 100K ¹⁾	$M_{0\ 100K}$	Nm	35.5			
Standstill current - 100K	$I_{0\ 100K}$	A	9.55			
Moment of inertia of rotor ¹⁾	J_{rot}	kg*m ²	0.0021	0.00251	0.0021	0.00251
Rated speed - 100K	$n_{N\ 100K}$	1/min	1215			
Rated torque - 100K ¹⁾	$M_{N\ 100K}$	Nm	33.1			
Rated current - 100K	$I_{N\ 100K}$	A	8.95			
Rated power - 100K ¹⁾	$P_{N\ 100K}$	kW	4.21			
Maximum torque 20 °C (cold) ¹⁾	$M_{max\ 20°C}$	Nm	79.7			
Maximum torque 100K (warm) ¹⁾	$M_{max\ 100K}$	Nm	73.2			
Maximum current	$I_{max(rms)}$	A	24.8			
Maximum speed (electrical)	$n_{max\ el}$	1/min	3000			
Maximum speed (mechanical)	$n_{max\ mech}$	1/min	6000			
Number of pole pairs	p		5			
Torque constant at 20 °C ¹⁾	K_m	Nm/A	4.09			
Voltage constant at 20 °C ¹⁾	K_E	V/1000 min ⁻¹	248			
Winding resistance at 20 °C	R_{12}	Ohm	2.71			
Winding inductance	L_{12_min}	mH	45.67			
Leakage capacitance of the component	C_{ab}	nF	4.71			
Thermal time constant of winding	T_{th_W}	s	45.8			
Thermal time constant of motor	T_{th_M}	min	10.7			
Mass	m_{mot}	kg	20	22.5	20	22.5
Holding brake						
Holding torque	M_4	Nm	0	36.00	0	36.00
Rated voltage	U_N	V	0	24	0	24
Rated current	I_N	A	0	0.94	0	0.94
Maximum connection time	t_1	ms	0	60	0	60
Maximum disconnection time	t_2	ms	0	200	0	200
Fan data						
Rated voltage	U_N	V	230		115	
Rated current	I_N	A	0.20/0.18		0.45	
Frequency	f_N	Hz	50/60		60	
1) For tolerance details refer to chapter 6.4 Tolerances			Latest amendment: 2020-02-13			

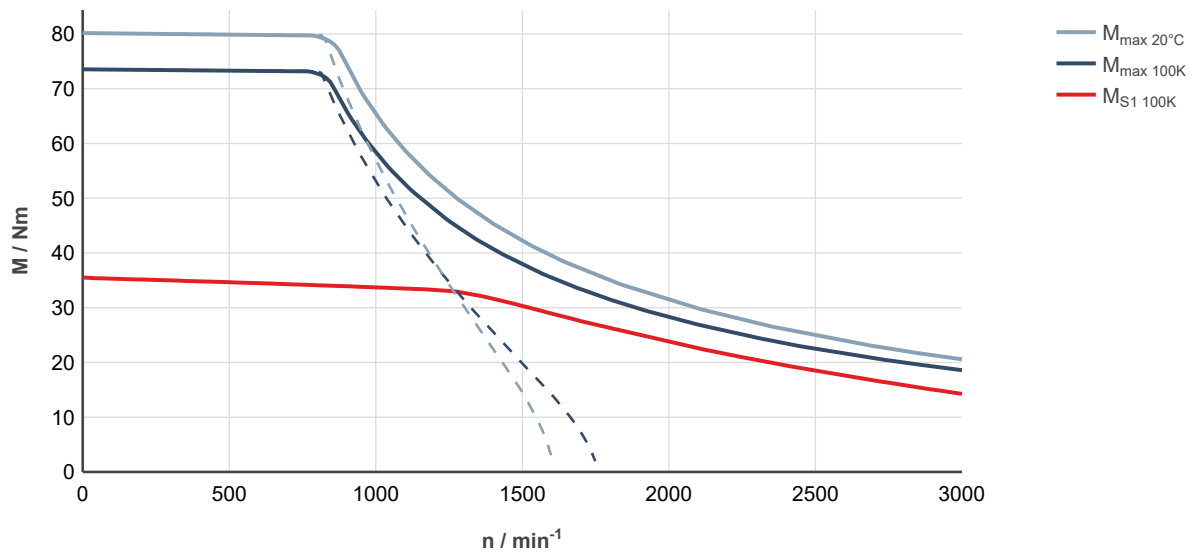

Fig. 135: MS2N07-D0BFA-...0-...-..., ctrlX DRIVE, uncontrolled supply 3 × AC 400 V

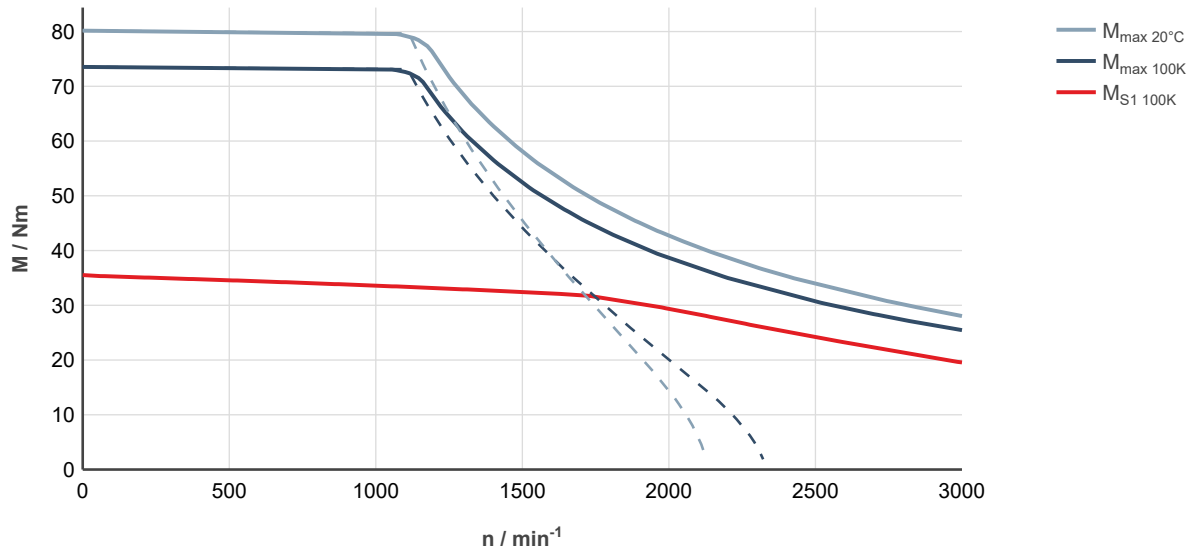

Fig. 136: MS2N07-D0BFA-...0-...-..., ctrlX DRIVE, controlled supply 3 × AC 400 ... 480 V

MS2N07-D0BHA/B

Designation	Symbol	Unit	MS2N07- D0BHA-__0- _N	MS2N07- D0BHA-__2- _N	MS2N07- D0BHB-__0- _N	MS2N07- D0BHB-__2- _N
Standstill torque - 100K ¹⁾	$M_{0\ 100K}$	Nm	35.5			
Standstill current - 100K	$I_{0\ 100K}$	A	14.1			
Moment of inertia of rotor ¹⁾	J_{rot}	kg*m ²	0.0021	0.00251	0.0021	0.00251
Rated speed - 100K	$n_{N\ 100K}$	1/min	1870			
Rated torque - 100K ¹⁾	$M_{N\ 100K}$	Nm	30.1			
Rated current - 100K	$I_{N\ 100K}$	A	12.1			
Rated power - 100K ¹⁾	$P_{N\ 100K}$	kW	5.9			
Maximum torque 20 °C (cold) ¹⁾	$M_{max\ 20°C}$	Nm	79.7			
Maximum torque 100K (warm) ¹⁾	$M_{max\ 100K}$	Nm	73.2			
Maximum current	$I_{max(rms)}$	A	36.4			
Maximum speed (electrical)	$n_{max\ el}$	1/min	4000			
Maximum speed (mechanical)	$n_{max\ mech}$	1/min	6000			
Number of pole pairs	p		5			
Torque constant at 20 °C ¹⁾	K_m	Nm/A	2.76			
Voltage constant at 20 °C ¹⁾	K_E	V/1000 min ⁻¹	167.5			
Winding resistance at 20 °C	R_{12}	Ohm	1.30			
Winding inductance	L_{12_min}	mH	20.2			
Leakage capacitance of the component	C_{ab}	nF	4.1			
Thermal time constant of winding	T_{th_W}	s	45.8			
Thermal time constant of motor	T_{th_M}	min	10.7			
Mass	m_{mot}	kg	20	22.5	20	22.5
Holding brake						
Holding torque	M_4	Nm	0	36.00	0	36.00
Rated voltage	U_N	V	0	24	0	24
Rated current	I_N	A	0	0.94	0	0.94
Maximum connection time	t_1	ms	0	60	0	60
Maximum disconnection time	t_2	ms	0	200	0	200
Fan data						
Rated voltage	U_N	V	230		115	
Rated current	I_N	A	0.20/0.18		0.45	
Frequency	f_N	Hz	50/60		60	
1) For tolerance details refer to chapter 6.4 Tolerances			Latest amendment: 2020-06-03			

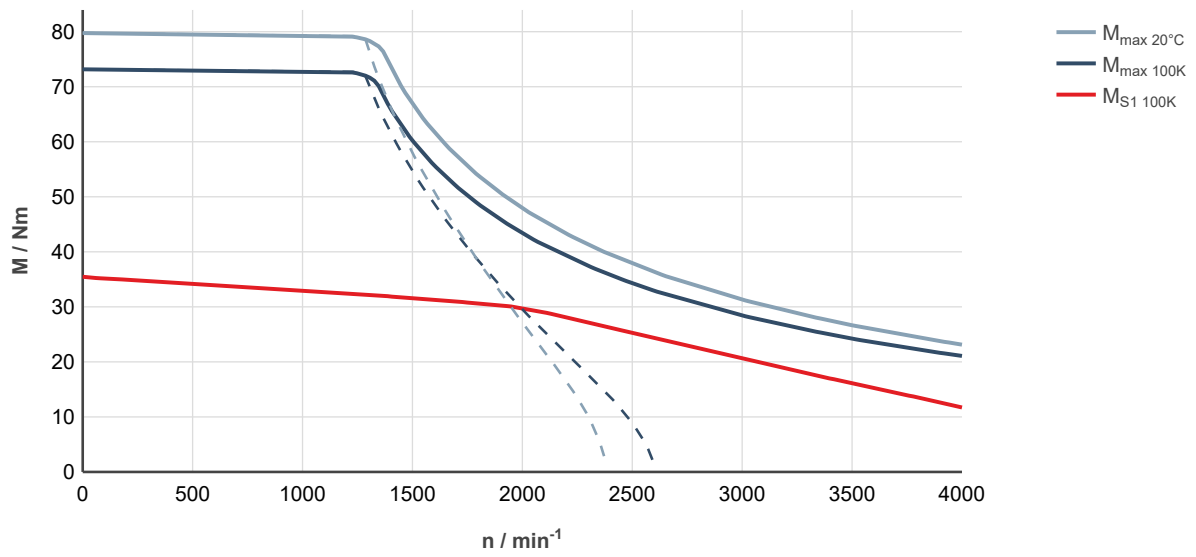

Fig. 137: MS2N07-D0BHA-___0-___-_, ctrlX DRIVE, uncontrolled supply 3 × AC 400 V

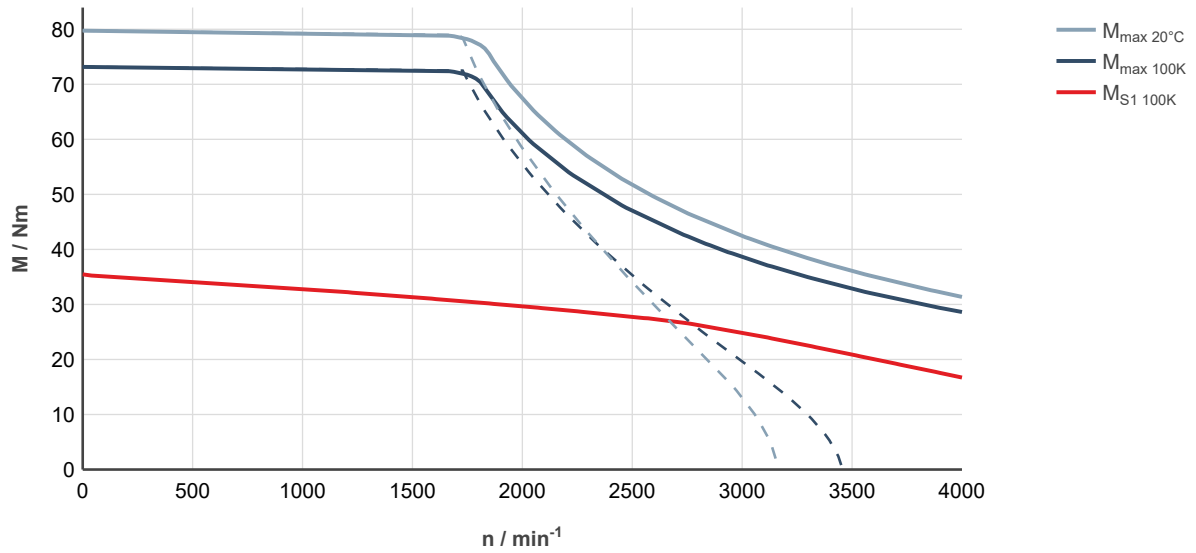

Fig. 138: MS2N07-D0BHA-___0-___-_, ctrlX DRIVE, controlled supply 3 × AC 400 ... 480 V

MS2N07-D0BNA/B

Designation	Symbol	Unit	MS2N07- D0BNA-__0- _N	MS2N07- D0BNA-__2- _N	MS2N07- D0BNB-__0- _N	MS2N07- D0BNB-__2- _N
Standstill torque - 100K ¹⁾	M _{0 100K}	Nm	35.5			
Standstill current - 100K	I _{0 100K}	A	19.1			
Moment of inertia of rotor ¹⁾	J _{rot}	kg*m ²	0.0021	0.00251	0.0021	0.00251
Rated speed - 100K	n _{N 100K}	1/min	2660			
Rated torque - 100K ¹⁾	M _{N 100K}	Nm	26.5			
Rated current - 100K	I _{N 100K}	A	14.5			
Rated power - 100K ¹⁾	P _{N 100K}	kW	7.4			
Maximum torque 20 °C (cold) ¹⁾	M _{max 20°C}	Nm	79.7			
Maximum torque 100K (warm) ¹⁾	M _{max 100K}	Nm	73.2			
Maximum current	I _{max(rms)}	A	49.5			
Maximum speed (electrical)	n _{max el}	1/min	6000			
Maximum speed (mechanical)	n _{max mech}	1/min	6000			
Number of pole pairs	p		5			
Torque constant at 20 °C ¹⁾	K _m	Nm/A	2.04			
Voltage constant at 20 °C ¹⁾	K _E	V/1000 min ⁻¹	124.1			
Winding resistance at 20 °C	R ₁₂	Ohm	0.671			
Winding inductance	L _{12_min}	mH	10.0			
Leakage capacitance of the component	C _{ab}	nF	4.0			
Thermal time constant of winding	T _{th_W}	s	45.8			
Thermal time constant of motor	T _{th_M}	min	10.7			
Mass	m _{mot}	kg	20	22.5	20	22.5
Holding brake						
Holding torque	M ₄	Nm	0	36.00	0	36.00
Rated voltage	U _N	V	0	24	0	24
Rated current	I _N	A	0	0.94	0	0.94
Maximum connection time	t ₁	ms	0	60	0	60
Maximum disconnection time	t ₂	ms	0	200	0	200
Fan data						
Rated voltage	U _N	V	230		115	
Rated current	I _N	A	0.20/0.18		0.45	
Frequency	f _N	Hz	50/60		60	
1) For tolerance details refer to chapter 6.4 Tolerances			Latest amendment: 2020-06-03			

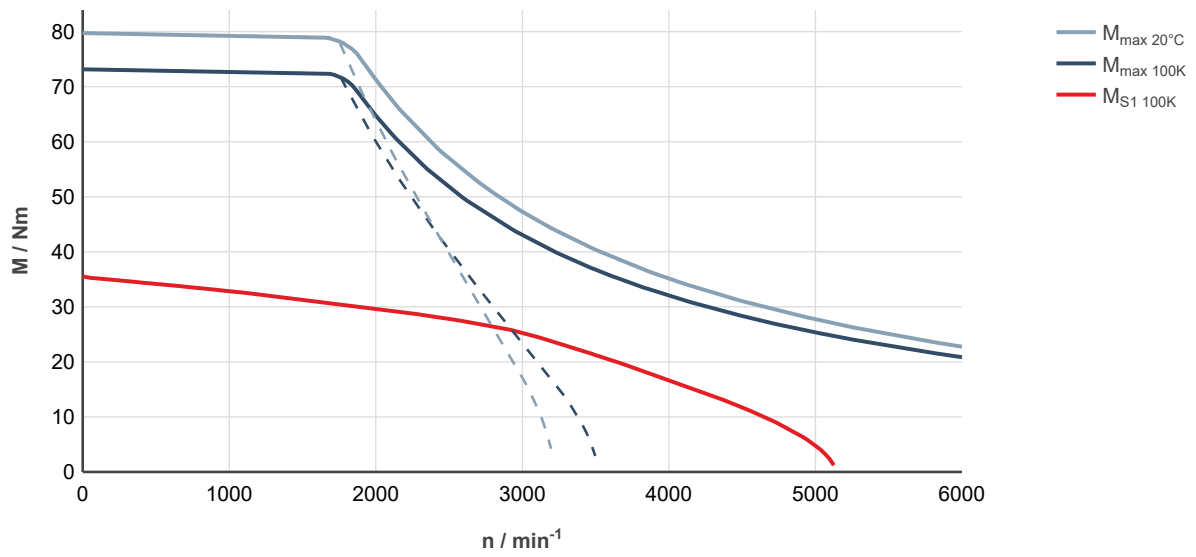

Fig. 139: MS2N07-D0BNA-___0-___-_, ctrlX DRIVE, uncontrolled supply 3 × AC 400 V

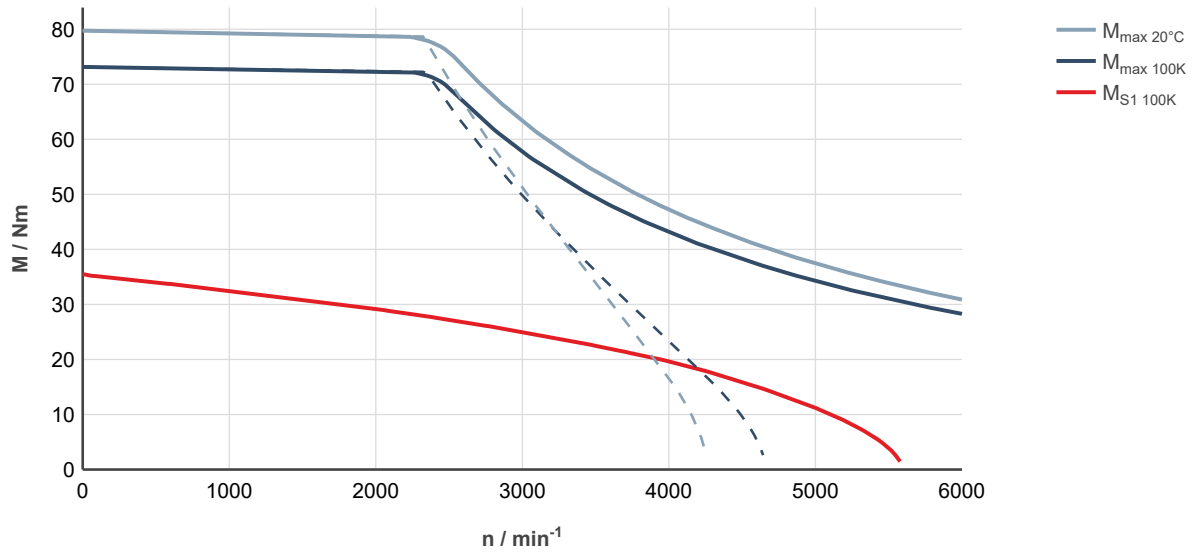

Fig. 140: MS2N07-D0BNA-___0-___-_, ctrlX DRIVE, controlled supply 3 × AC 400 ... 480 V

MS2N07-D0BRA/B

Designation	Symbol	Unit	MS2N07- D0BRA-__0- _N	MS2N07- D0BRA-__2- _N	MS2N07- D0BRB- __0-_N	MS2N07- D0BRB-__2- _N
Standstill torque - 100K ¹⁾	$M_{0\ 100K}$	Nm	35.5			
Standstill current - 100K	$I_{0\ 100K}$	A	28.2			
Moment of inertia of rotor ¹⁾	J_{rot}	kg*m ²	0.0021	0.00251	0.0021	0.00251
Rated speed - 100K	$n_{N\ 100K}$	1/min	3650			
Rated torque - 100K ¹⁾	$M_{N\ 100K}$	Nm	18.7			
Rated current - 100K	$I_{N\ 100K}$	A	15.4			
Rated power - 100K ¹⁾	$P_{N\ 100K}$	kW	7.15			
Maximum torque 20 °C (cold) ¹⁾	$M_{max\ 20°C}$	Nm	79.7			
Maximum torque 100K (warm) ¹⁾	$M_{max\ 100K}$	Nm	73.2			
Maximum current	$I_{max(rms)}$	A	72.7			
Maximum speed (electrical)	$n_{max\ el}$	1/min	6000			
Maximum speed (mechanical)	$n_{max\ mech}$	1/min	6000			
Number of pole pairs	p		5			
Torque constant at 20 °C ¹⁾	K_m	Nm/A	1.38			
Voltage constant at 20 °C ¹⁾	K_E	V/1000 min ⁻¹	83.9			
Winding resistance at 20 °C	R_{12}	Ohm	0.327			
Winding inductance	L_{12_min}	mH	5.06			
Leakage capacitance of the component	C_{ab}	nF	3.95			
Thermal time constant of winding	T_{th_W}	s	45.8			
Thermal time constant of motor	T_{th_M}	min	10.7			
Mass	m_{mot}	kg	20	22.5	20	22.5
Holding brake						
Holding torque	M_4	Nm	0	36.00	0	36.00
Rated voltage	U_N	V	0	24	0	24
Rated current	I_N	A	0	0.94	0	0.94
Maximum connection time	t_1	ms	0	60	0	60
Maximum disconnection time	t_2	ms	0	200	0	200
Fan data						
Rated voltage	U_N	V	230		115	
Rated current	I_N	A	0.20/0.18		0.45	
Frequency	f_N	Hz	50/60		60	
1) For tolerance details refer to chapter 6.4 Tolerances			Latest amendment: 2017-08-09			

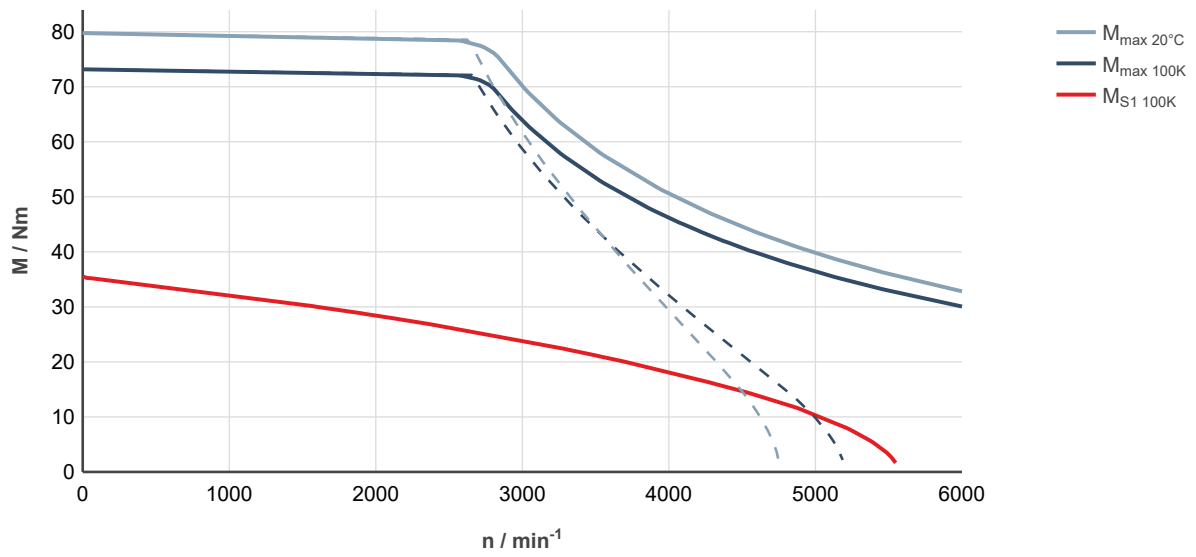

Fig. 141: MS2N07-D0BRA-___0-___-_, ctrlX DRIVE, uncontrolled supply 3 × AC 400 V

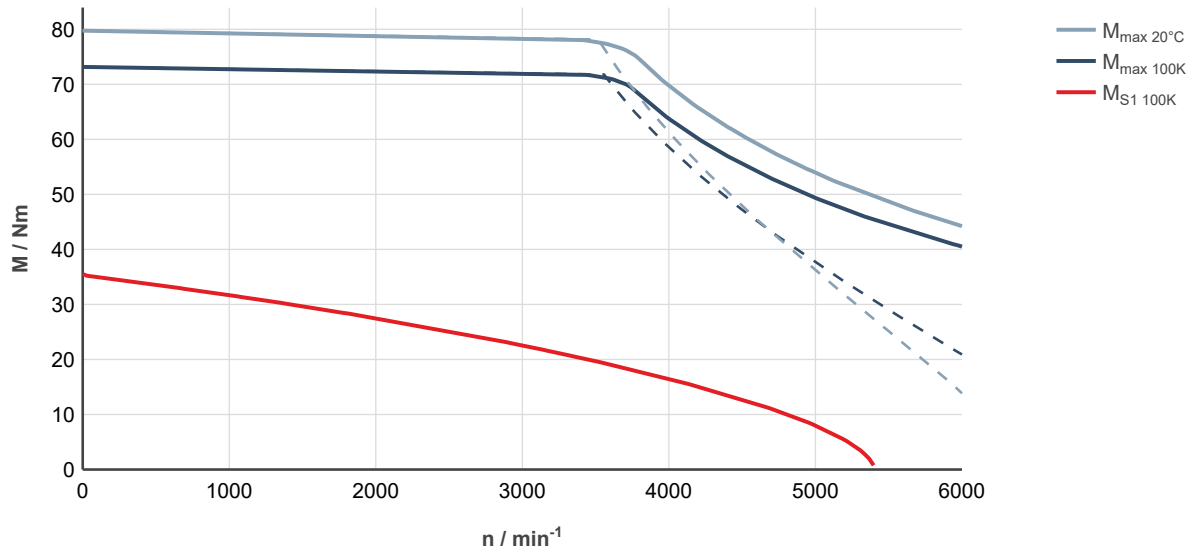

Fig. 142: MS2N07-D0BRA-___0-___-_, ctrlX DRIVE, controlled supply 3 × AC 400 ... 480 V

MS2N07-D1BFA/B

Designation	Symbol	Unit	MS2N07- D1BFA-__0- _N	MS2N07- D1BFA-__2- _N	MS2N07- D1BFB-__0- _N	MS2N07- D1BFB-__2- _N
Standstill torque - 100K ¹⁾	$M_{0\ 100K}$	Nm	31.0			
Standstill current - 100K	$I_{0\ 100K}$	A	9.0			
Moment of inertia of rotor ¹⁾	J_{rot}	kg*m ²	0.00529	0.00570	0.00529	0.00570
Rated speed - 100K	$n_{N\ 100K}$	1/min	1480			
Rated torque - 100K ¹⁾	$M_{N\ 100K}$	Nm	28.5			
Rated current - 100K	$I_{N\ 100K}$	A	8.4			
Rated power - 100K ¹⁾	$P_{N\ 100K}$	kW	4.42			
Maximum torque 20 °C (cold) ¹⁾	$M_{max\ 20°C}$	Nm	92.5			
Maximum torque 100K (warm) ¹⁾	$M_{max\ 100K}$	Nm	84.8			
Maximum current	$I_{max(rms)}$	A	29.5			
Maximum speed (electrical)	$n_{max\ el}$	1/min	3000			
Maximum speed (mechanical)	$n_{max\ mech}$	1/min	6000			
Number of pole pairs	p		5			
Torque constant at 20 °C ¹⁾	K_m	Nm/A	3.73			
Voltage constant at 20 °C ¹⁾	K_E	V/1000 min ⁻¹	226.5			
Winding resistance at 20 °C	R_{12}	Ohm	2.93			
Winding inductance	L_{12_min}	mH	28.7			
Leakage capacitance of the component	C_{ab}	nF	3.65			
Thermal time constant of winding	T_{th_W}	s	38.9			
Thermal time constant of motor	T_{th_M}	min	10.7			
Mass	m_{mot}	kg	21.0	24.0	21.0	24.0
Holding brake						
Holding torque	M_4	Nm	0	36.00	0	36.00
Rated voltage	U_N	V	0	24	0	24
Rated current	I_N	A	0	0.94	0	0.94
Maximum connection time	t_1	ms	0	60	0	60
Maximum disconnection time	t_2	ms	0	200	0	200
Fan data						
Rated voltage	U_N	V	230		115	
Rated current	I_N	A	0.20/0.18		0.45	
Frequency	f_N	Hz	50/60		60	
1) For tolerance details refer to chapter 6.4 Tolerances			Latest amendment: 2020-06-03			

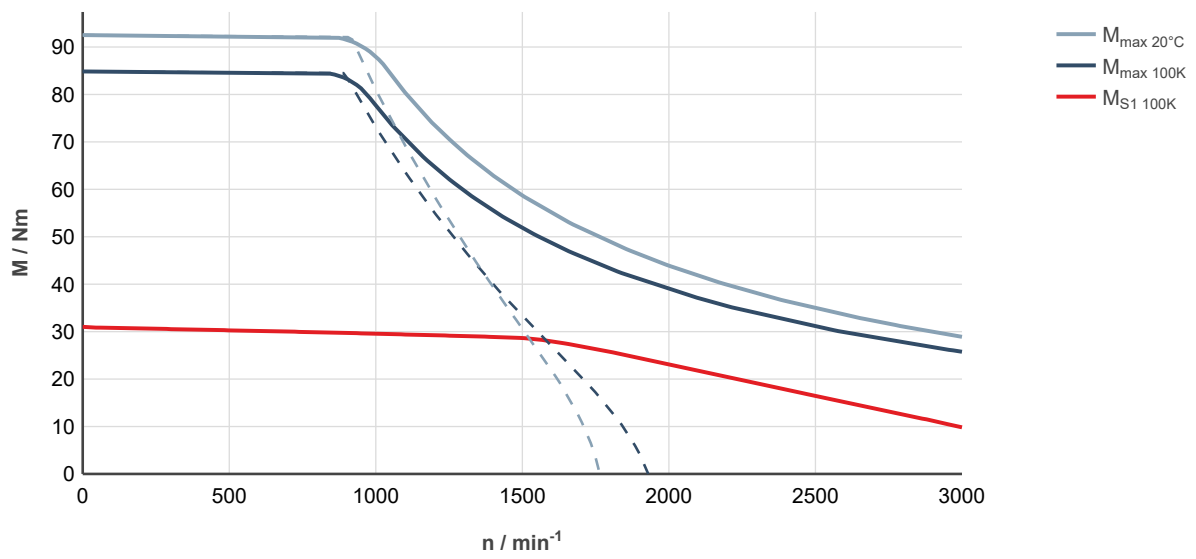

Fig. 143: MS2N07-D1BFA-___0-___-__, ctrlX DRIVE, uncontrolled supply 3 × AC 400 V

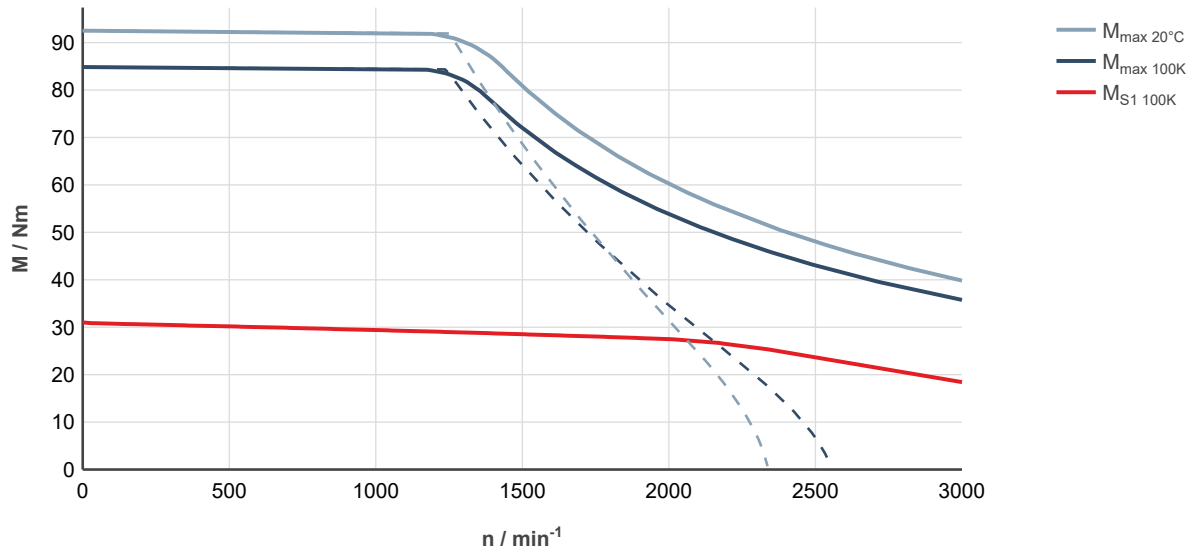

Fig. 144: MS2N07-D1BFA-___0-___-__, ctrlX DRIVE, controlled supply 3 × AC 400 ... 480 V

MS2N07-D1BHA/B

Designation	Symbol	Unit	MS2N07- D1BHA-__0- _N	MS2N07- D1BHA-__2- _N	MS2N07- D1BHB-__0- _N	MS2N07- D1BHB-__2- _N
Standstill torque - 100K ¹⁾	M _{0 100K}	Nm	31.0			
Standstill current - 100K	I _{0 100K}	A	12.9			
Moment of inertia of rotor ¹⁾	J _{rot}	kg*m ²	0.00529	0.00570	0.00529	0.00570
Rated speed - 100K	n _{N 100K}	1/min	2000			
Rated torque - 100K ¹⁾	M _{N 100K}	Nm	26.4			
Rated current - 100K	I _{N 100K}	A	11.25			
Rated power - 100K ¹⁾	P _{N 100K}	kW	5.50			
Maximum torque 20 °C (cold) ¹⁾	M _{max 20°C}	Nm	92.5			
Maximum torque 100K (warm) ¹⁾	M _{max 100K}	Nm	84.8			
Maximum current	I _{max(rms)}	A	42.7			
Maximum speed (electrical)	n _{max el}	1/min	4000			
Maximum speed (mechanical)	n _{max mech}	1/min	6000			
Number of pole pairs	p		5			
Torque constant at 20 °C ¹⁾	K _m	Nm/A	2.59			
Voltage constant at 20 °C ¹⁾	K _E	V/1000 min ⁻¹	157.5			
Winding resistance at 20 °C	R ₁₂	Ohm	1.56			
Winding inductance	L _{12_min}	mH	12.8			
Leakage capacitance of the component	C _{ab}	nF	3.1			
Thermal time constant of winding	T _{th_W}	s	38.9			
Thermal time constant of motor	T _{th_M}	min	10.7			
Mass	m _{mot}	kg	21.0	24.0	21.0	24.0
Holding brake						
Holding torque	M ₄	Nm	0	36.00	0	36.00
Rated voltage	U _N	V	0	24	0	24
Rated current	I _N	A	0	0.94	0	0.94
Maximum connection time	t ₁	ms	0	60	0	60
Maximum disconnection time	t ₂	ms	0	200	0	200
Fan data						
Rated voltage	U _N	V	230		115	
Rated current	I _N	A	0.20/0.18		0.45	
Frequency	f _N	Hz	50/60		60	
1) For tolerance details refer to chapter 6.4 Tolerances			Latest amendment: 2017-08-09			

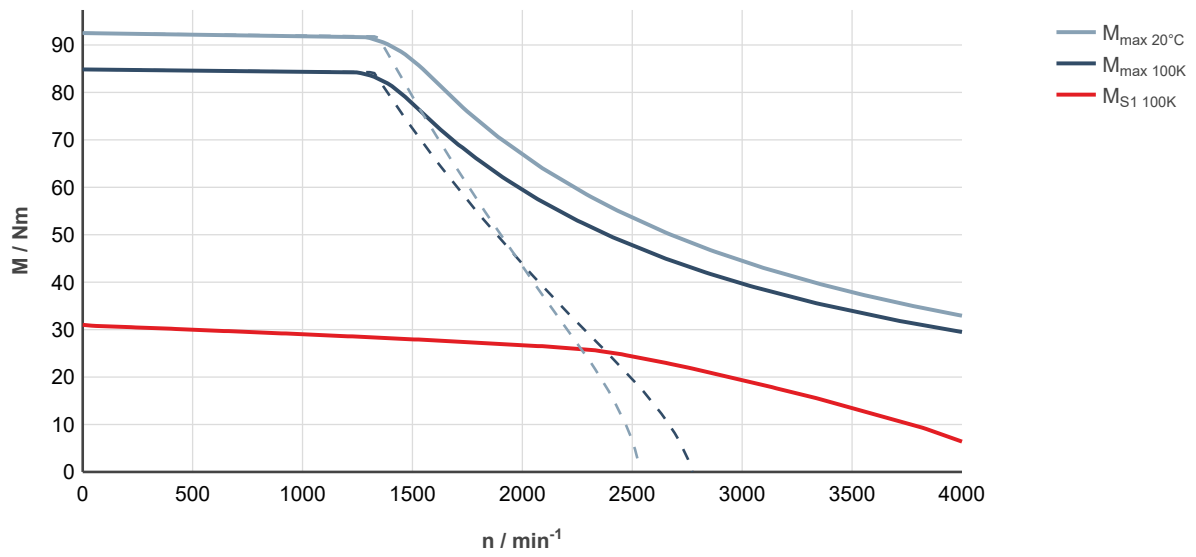

Fig. 145: MS2N07-D1BHA-___0-___-_, ctrlX DRIVE, uncontrolled supply 3 × AC 400 V

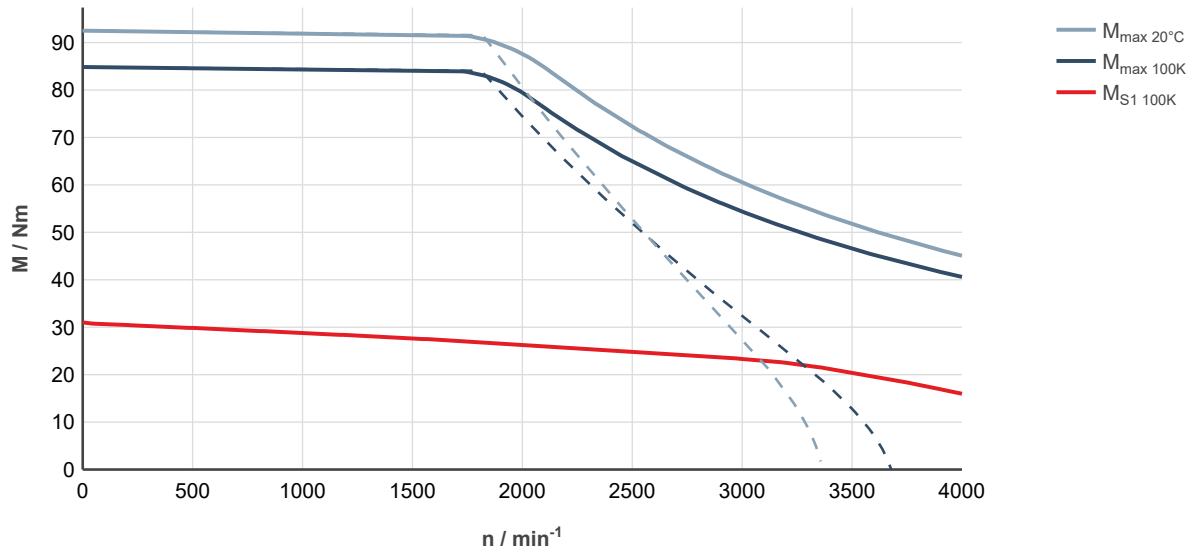

Fig. 146: MS2N07-D1BHA-___0-___-_, ctrlX DRIVE, controlled supply 3 × AC 400 ... 480 V

MS2N07-D1BNA/B

Designation	Symbol	Unit	MS2N07- D1BNA-__0- _N	MS2N07- D1BNA-__2- _N	MS2N07- D1BNB-__0- _N	MS2N07- D1BNB-__2- _N
Standstill torque - 100K ¹⁾	M _{0 100K}	Nm	31.0			
Standstill current - 100K	I _{0 100K}	A	16.3			
Moment of inertia of rotor ¹⁾	J _{rot}	kg*m ²	0.00529	0.00570	0.00529	0.00570
Rated speed - 100K	n _{N 100K}	1/min	2870			
Rated torque - 100K ¹⁾	M _{N 100K}	Nm	23.0			
Rated current - 100K	I _{N 100K}	A	12.55			
Rated power - 100K ¹⁾	P _{N 100K}	kW	6.9			
Maximum torque 20 °C (cold) ¹⁾	M _{max 20°C}	Nm	92.5			
Maximum torque 100K (warm) ¹⁾	M _{max 100K}	Nm	84.8			
Maximum current	I _{max(rms)}	A	54.1			
Maximum speed (electrical)	n _{max el}	1/min	6000			
Maximum speed (mechanical)	n _{max mech}	1/min	6000			
Number of pole pairs	p		5			
Torque constant at 20 °C ¹⁾	K _m	Nm/A	2.05			
Voltage constant at 20 °C ¹⁾	K _E	V/1000 min ⁻¹	124.3			
Winding resistance at 20 °C	R ₁₂	Ohm	0.942			
Winding inductance	L _{12_min}	mH	7.9			
Leakage capacitance of the component	C _{ab}	nF	3.0			
Thermal time constant of winding	T _{th_W}	s	38.9			
Thermal time constant of motor	T _{th_M}	min	10.7			
Mass	m _{mot}	kg	21.0	24.0	21.0	24.0
Holding brake						
Holding torque	M ₄	Nm	0	36.00	0	36.00
Rated voltage	U _N	V	0	24	0	24
Rated current	I _N	A	0	0.94	0	0.94
Maximum connection time	t ₁	ms	0	60	0	60
Maximum disconnection time	t ₂	ms	0	200	0	200
Fan data						
Rated voltage	U _N	V	230		115	
Rated current	I _N	A	0.20/0.18		0.45	
Frequency	f _N	Hz	50/60		60	
1) For tolerance details refer to chapter 6.4 Tolerances			Latest amendment: 2017-08-09			

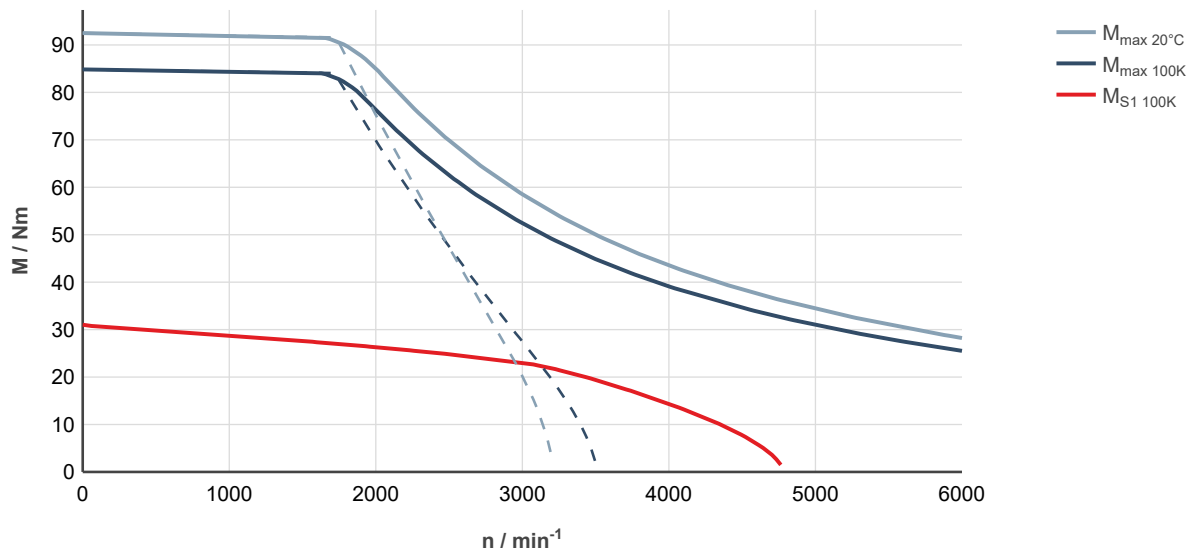

Fig. 147: MS2N07-D1BNA-___0-___- , ctrlX DRIVE, uncontrolled supply 3 × AC 400 V

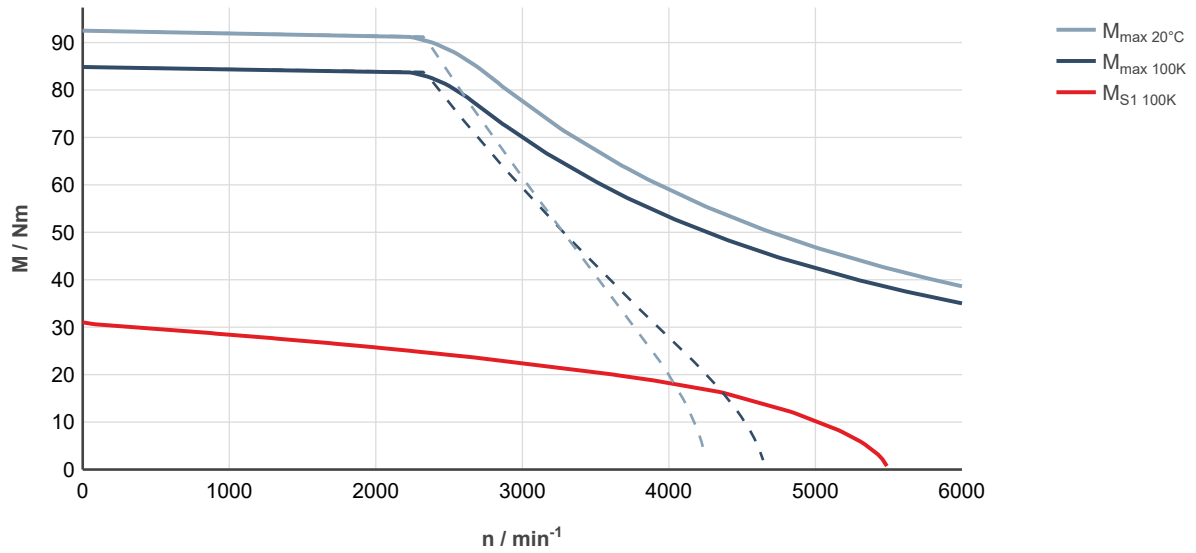

Fig. 148: MS2N07-D1BNA-___0-___- , ctrlX DRIVE, controlled supply 3 × AC 400 ... 480 V

MS2N07-E0BDA/B

Designation	Symbol	Unit	MS2N07- E0BDA-__0- _N			
			MS2N07- E0BDA-__2- _N	MS2N07- E0BDB-__0- _N	MS2N07- E0BDB-__2- _N	
Standstill torque - 100K ¹⁾	M _{0 100K}	Nm	49.5			
Standstill current - 100K	I _{0 100K}	A	8.9			
Moment of inertia of rotor ¹⁾	J _{rot}	kg*m ²	0.003	0.00341	0.003	0.00341
Rated speed - 100K	n _{N 100K}	1/min	815			
Rated torque - 100K ¹⁾	M _{N 100K}	Nm	47.3			
Rated current - 100K	I _{N 100K}	A	8.55			
Rated power - 100K ¹⁾	P _{N 100K}	kW	4.04			
Maximum torque 20 °C (cold) ¹⁾	M _{max 20°C}	Nm	119.5			
Maximum torque 100K (warm) ¹⁾	M _{max 100K}	Nm	109.5			
Maximum current	I _{max(rms)}	A	24.8			
Maximum speed (electrical)	n _{max el}	1/min	2000			
Maximum speed (mechanical)	n _{max mech}	1/min	6000			
Number of pole pairs	p		5			
Torque constant at 20 °C ¹⁾	K _m	Nm/A	6.09			
Voltage constant at 20 °C ¹⁾	K _E	V/1000 min ⁻¹	370			
Winding resistance at 20 °C	R ₁₂	Ohm	3.72			
Winding inductance	L _{12_min}	mH	65.9			
Leakage capacitance of the component	C _{ab}	nF	6.95			
Thermal time constant of winding	T _{th_W}	s	51.5			
Thermal time constant of motor	T _{th_M}	min	12.5			
Mass	m _{mot}	kg	26	29	26	29
Holding brake						
Holding torque	M ₄	Nm	0	36.00	0	36.00
Rated voltage	U _N	V	0	24	0	24
Rated current	I _N	A	0	0.94	0	0.94
Maximum connection time	t ₁	ms	0	60	0	60
Maximum disconnection time	t ₂	ms	0	200	0	200
Fan data						
Rated voltage	U _N	V	230		115	
Rated current	I _N	A	0.20/0.18		0.45	
Frequency	f _N	Hz	50/60		60	
1) For tolerance details refer to chapter 6.4 Tolerances			Latest amendment: 2020-02-13			

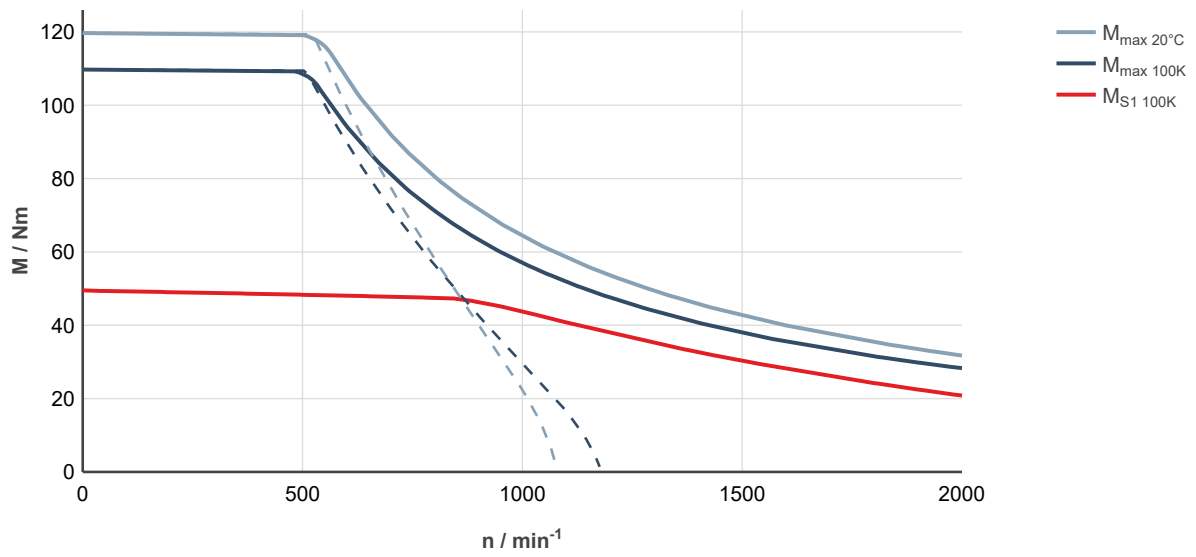

Fig. 149: MS2N07-E0BDA-___0-___-__, ctrlX DRIVE, uncontrolled supply 3 × AC 400 V

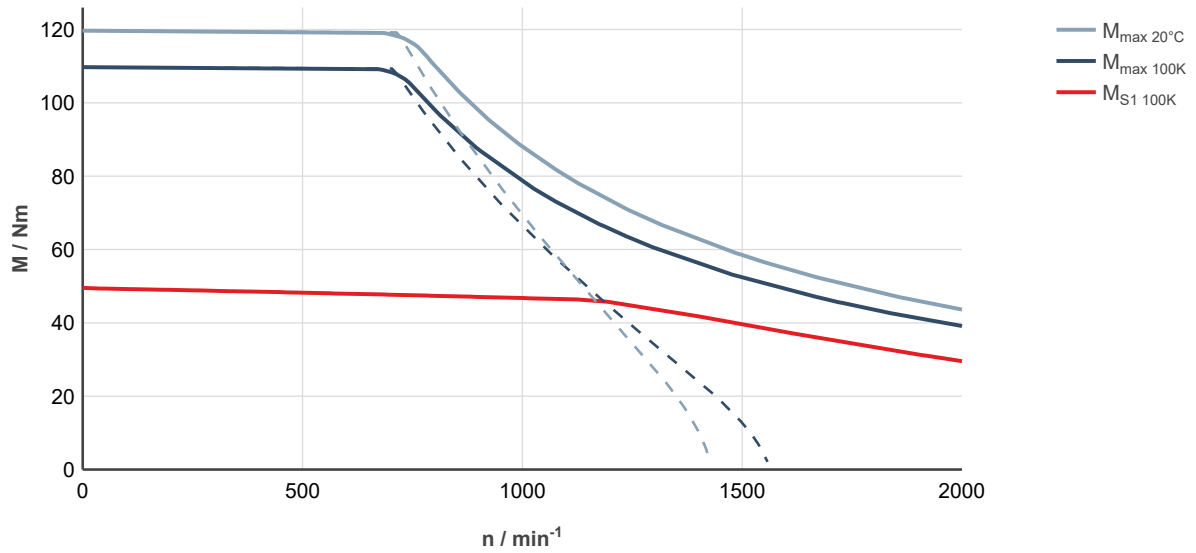

Fig. 150: MS2N07-E0BDA-___0-___-__, ctrlX DRIVE, controlled supply 3 × AC 400 ... 480 V

MS2N07-E0BHA/B

Designation	Symbol	Unit	MS2N07- E0BHA-__0- _N		MS2N07- E0BHA-__2- _N		MS2N07- E0BHB-__0- _N		MS2N07- E0BHB-__2- _N	
Standstill torque - 100K ¹⁾	M _{0 100K}	Nm	49.5							
Standstill current - 100K	I _{0 100K}	A	17.9							
Moment of inertia of rotor ¹⁾	J _{rot}	kg*m ²	0.003	0.00341	0.003	0.00341				
Rated speed - 100K	n _{N 100K}	1/min	1760							
Rated torque - 100K ¹⁾	M _{N 100K}	Nm	41.6							
Rated current - 100K	I _{N 100K}	A	15.8							
Rated power - 100K ¹⁾	P _{N 100K}	kW	8.05							
Maximum torque 20 °C (cold) ¹⁾	M _{max 20°C}	Nm	119.5							
Maximum torque 100K (warm) ¹⁾	M _{max 100K}	Nm	109.5							
Maximum current	I _{max(rms)}	A	49.5							
Maximum speed (electrical)	n _{max el}	1/min	4000							
Maximum speed (mechanical)	n _{max mech}	1/min	6000							
Number of pole pairs	p		5							
Torque constant at 20 °C ¹⁾	K _m	Nm/A	3.03							
Voltage constant at 20 °C ¹⁾	K _E	V/1000 min ⁻¹	184.3							
Winding resistance at 20 °C	R ₁₂	Ohm	0.95							
Winding inductance	L _{12_min}	mH	14.8							
Leakage capacitance of the component	C _{ab}	nF	7.1							
Thermal time constant of winding	T _{th_W}	s	51.5							
Thermal time constant of motor	T _{th_M}	min	12.5							
Mass	m _{mot}	kg	26	29	26	29				
Holding brake										
Holding torque	M ₄	Nm	0	36.00	0	36.00				
Rated voltage	U _N	V	0	24	0	24				
Rated current	I _N	A	0	0.94	0	0.94				
Maximum connection time	t ₁	ms	0	60	0	60				
Maximum disconnection time	t ₂	ms	0	200	0	200				
Fan data										
Rated voltage	U _N	V	230				115			
Rated current	I _N	A	0.20/0.18				0.45			
Frequency	f _N	Hz	50/60				60			
1) For tolerance details refer to chapter 6.4 Tolerances Latest amendment: 2017-08-09										

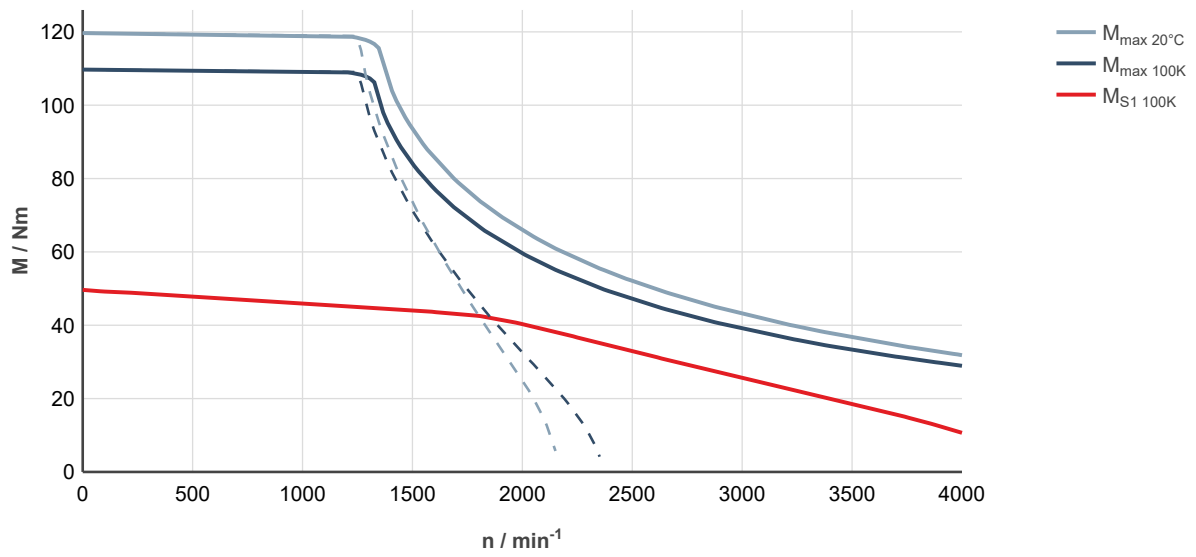

Fig. 151: MS2N07-E0BHA-___0-___-__, ctrlX DRIVE, uncontrolled supply 3 × AC 400 V

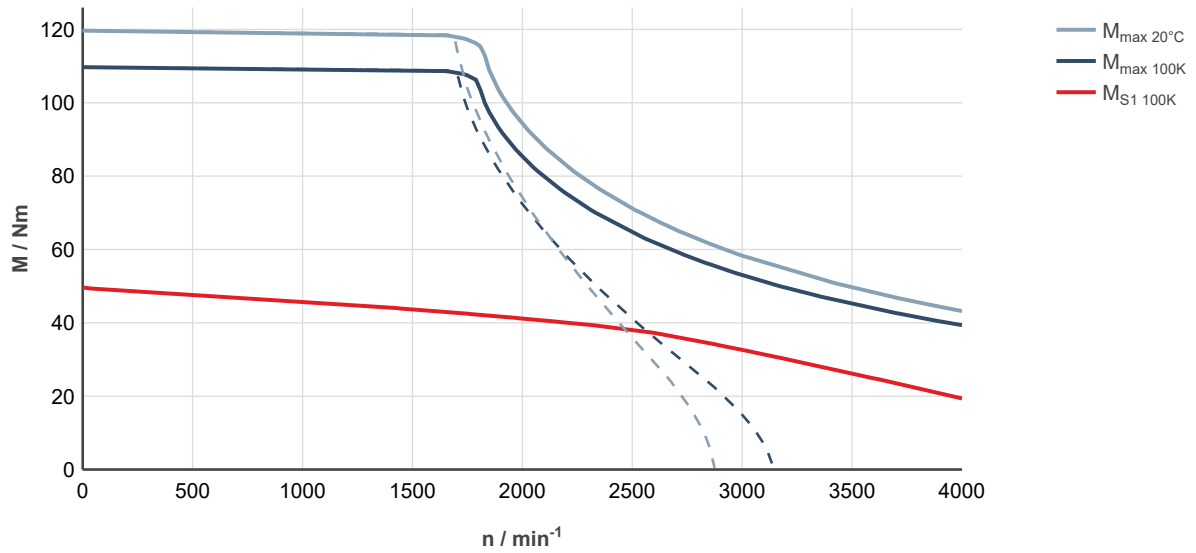

Fig. 152: MS2N07-E0BHA-___0-___-__, ctrlX DRIVE, controlled supply 3 × AC 400 ... 480 V

MS2N07-E0BNA/B

Designation	Symbol	Unit	MS2N07- E0BNA-__0- _N			
			MS2N07- E0BNA-__2- _N	MS2N07- E0BNA-__2- _N	MS2N07- E0BNB-__0- _N	MS2N07- E0BNB-__2- _N
Standstill torque - 100K ¹⁾	M _{0 100K}	Nm	49.5			
Standstill current - 100K	I _{0 100K}	A	26.2			
Moment of inertia of rotor ¹⁾	J _{rot}	kg*m ²	0.003	0.00341	0.003	0.00341
Rated speed - 100K	n _{N 100K}	1/min	2730			
Rated torque - 100K ¹⁾	M _{N 100K}	Nm	34.4			
Rated current - 100K	I _{N 100K}	A	18.6			
Rated power - 100K ¹⁾	P _{N 100K}	kW	9.85			
Maximum torque 20 °C (cold) ¹⁾	M _{max 20°C}	Nm	119.5			
Maximum torque 100K (warm) ¹⁾	M _{max 100K}	Nm	109.5			
Maximum current	I _{max(rms)}	A	72.7			
Maximum speed (electrical)	n _{max el}	1/min	6000			
Maximum speed (mechanical)	n _{max mech}	1/min	6000			
Number of pole pairs	p		5			
Torque constant at 20 °C ¹⁾	K _m	Nm/A	2.08			
Voltage constant at 20 °C ¹⁾	K _E	V/1000 min ⁻¹	126.2			
Winding resistance at 20 °C	R ₁₂	Ohm	0.455			
Winding inductance	L _{12_min}	mH	7.50			
Leakage capacitance of the component	C _{ab}	nF	6.11			
Thermal time constant of winding	T _{th_W}	s	51.5			
Thermal time constant of motor	T _{th_M}	min	12.5			
Mass	m _{mot}	kg	26	29	26	29
Holding brake						
Holding torque	M ₄	Nm	0	36.00	0	36.00
Rated voltage	U _N	V	0	24	0	24
Rated current	I _N	A	0	0.94	0	0.94
Maximum connection time	t ₁	ms	0	60	0	60
Maximum disconnection time	t ₂	ms	0	200	0	200
Fan data						
Rated voltage	U _N	V	230		115	
Rated current	I _N	A	0.20/0.18		0.45	
Frequency	f _N	Hz	50/60		60	
1) For tolerance details refer to chapter 6.4 Tolerances			Latest amendment: 2017-08-09			

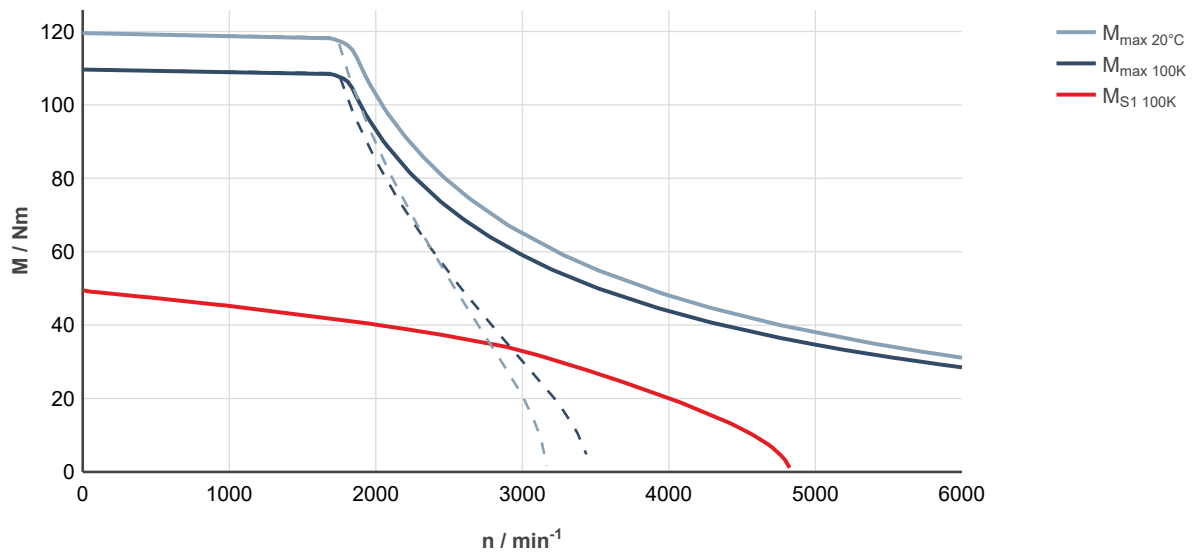

Fig. 153: MS2N07-E0BNA-___0-___-_, ctrIX DRIVE, uncontrolled supply 3 × AC 400 V

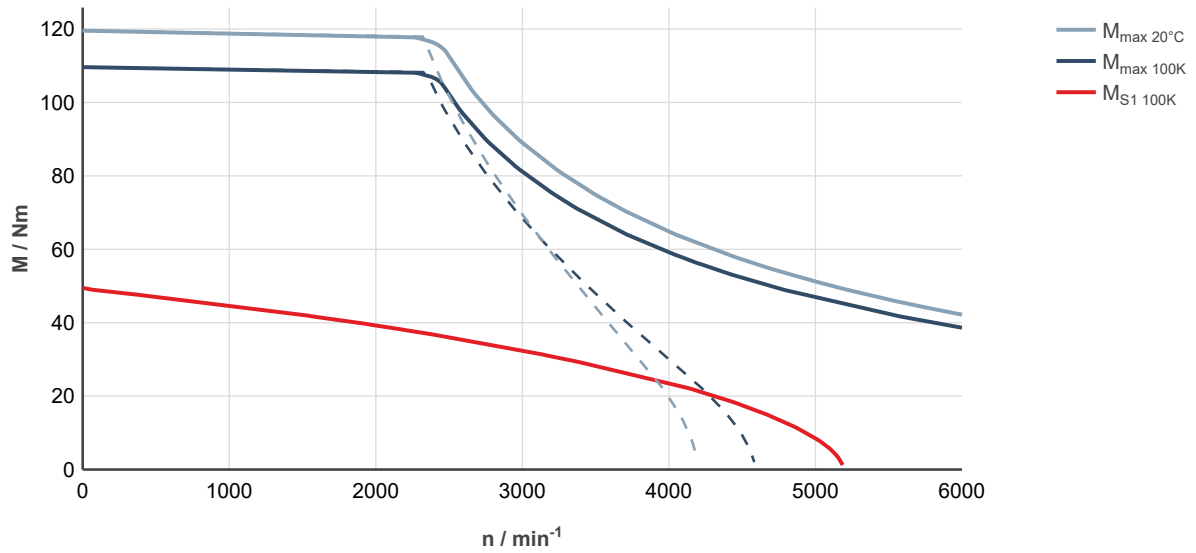

Fig. 154: MS2N07-E0BNA-___0-___-_, ctrIX DRIVE, controlled supply 3 × AC 400 ... 480 V

MS2N07-E0BQA/B

Designation	Symbol	Unit	MS2N07- E0BQA-__0- _N	MS2N07- E0BQA-__2- _N	MS2N07- E0BQB- __0-_N	MS2N07- E0BQB-__2- _N
Standstill torque - 100K ¹⁾	M _{0 100K}	Nm	49.5			
Standstill current - 100K	I _{0 100K}	A	33.3			
Moment of inertia of rotor ¹⁾	J _{rot}	kg*m ²	0.003	0.00341	0.003	0.00341
Rated speed - 100K	n _{N 100K}	1/min	3300			
Rated torque - 100K ¹⁾	M _{N 100K}	Nm	27.3			
Rated current - 100K	I _{N 100K}	A	19.0			
Rated power - 100K ¹⁾	P _{N 100K}	kW	9.45			
Maximum torque 20 °C (cold) ¹⁾	M _{max 20°C}	Nm	119.5			
Maximum torque 100K (warm) ¹⁾	M _{max 100K}	Nm	109.5			
Maximum current	I _{max(rms)}	A	92.3			
Maximum speed (electrical)	n _{max el}	1/min	6000			
Maximum speed (mechanical)	n _{max mech}	1/min	6000			
Number of pole pairs	p		5			
Torque constant at 20 °C ¹⁾	K _m	Nm/A	1.64			
Voltage constant at 20 °C ¹⁾	K _E	V/1000 min ⁻¹	99.3			
Winding resistance at 20 °C	R ₁₂	Ohm	0.282			
Winding inductance	L _{12_min}	mH	4.64			
Leakage capacitance of the component	C _{ab}	nF	6.21			
Thermal time constant of winding	T _{th_W}	s	51.5			
Thermal time constant of motor	T _{th_M}	min	12.5			
Mass	m _{mot}	kg	26	29	26	29
Holding brake						
Holding torque	M ₄	Nm	0	36.00	0	36.00
Rated voltage	U _N	V	0	24	0	24
Rated current	I _N	A	0	0.94	0	0.94
Maximum connection time	t ₁	ms	0	60	0	60
Maximum disconnection time	t ₂	ms	0	200	0	200
Fan data						
Rated voltage	U _N	V	230		115	
Rated current	I _N	A	0.20/0.18		0.45	
Frequency	f _N	Hz	50/60		60	
1) For tolerance details refer to chapter 6.4 Tolerances			Latest amendment: 2017-08-09			

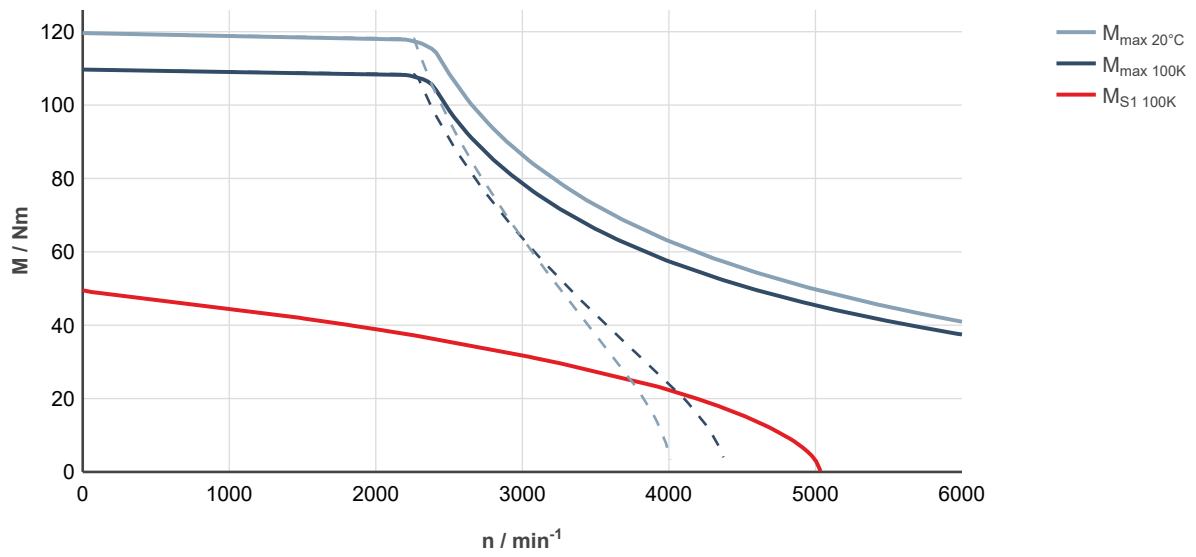

Fig. 155: MS2N07-E0BQA-___0-___-_, ctrlX DRIVE, uncontrolled supply 3 × AC 400 V

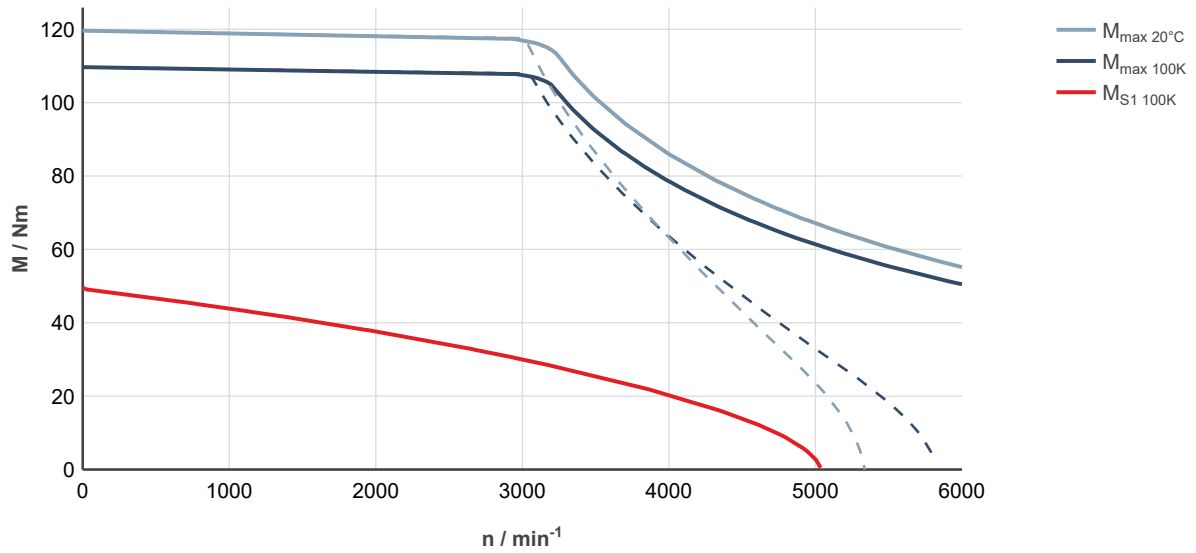

Fig. 156: MS2N07-E0BQA-___0-___-_, ctrlX DRIVE, controlled supply 3 × AC 400 ... 480 V

MS2N07-E1BDA/B

Designation	Symbol	Unit	MS2N07- E1BDA-__0- _N			
			MS2N07- E1BDA-__2- _N	MS2N07- E1BDA-__2- _N	MS2N07- E1BDB-__0- _N	MS2N07- E1BDB-__2- _N
Standstill torque - 100K ¹⁾	M _{0 100K}	Nm	43.5			
Standstill current - 100K	I _{0 100K}	A	8.35			
Moment of inertia of rotor ¹⁾	J _{rot}	kg*m ²	0.00752	0.00793	0.00752	0.00793
Rated speed - 100K	n _{N 100K}	1/min	960			
Rated torque - 100K ¹⁾	M _{N 100K}	Nm	41.5			
Rated current - 100K	I _{N 100K}	A	8.05			
Rated power - 100K ¹⁾	P _{N 100K}	kW	4.17			
Maximum torque 20 °C (cold) ¹⁾	M _{max 20°C}	Nm	140			
Maximum torque 100K (warm) ¹⁾	M _{max 100K}	Nm	128.5			
Maximum current	I _{max(rms)}	A	29.5			
Maximum speed (electrical)	n _{max el}	1/min	2000			
Maximum speed (mechanical)	n _{max mech}	1/min	6000			
Number of pole pairs	p		5			
Torque constant at 20 °C ¹⁾	K _m	Nm/A	5.63			
Voltage constant at 20 °C ¹⁾	K _E	V/1000 min ⁻¹	341.8			
Winding resistance at 20 °C	R ₁₂	Ohm	4.2			
Winding inductance	L _{12_min}	mH	42.9			
Leakage capacitance of the component	C _{ab}	nF	5.7			
Thermal time constant of winding	T _{th_W}	s	43.0			
Thermal time constant of motor	T _{th_M}	min	12.5			
Mass	m _{mot}	kg	26	29	26	29
Holding brake						
Holding torque	M ₄	Nm	0	36.00	0	36.00
Rated voltage	U _N	V	0	24	0	24
Rated current	I _N	A	0	0.94	0	0.94
Maximum connection time	t ₁	ms	0	60	0	60
Maximum disconnection time	t ₂	ms	0	200	0	200
Fan data						
Rated voltage	U _N	V	230		115	
Rated current	I _N	A	0.20/0.18		0.45	
Frequency	f _N	Hz	50/60		60	
1) For tolerance details refer to chapter 6.4 Tolerances			Latest amendment: 2020-02-10			

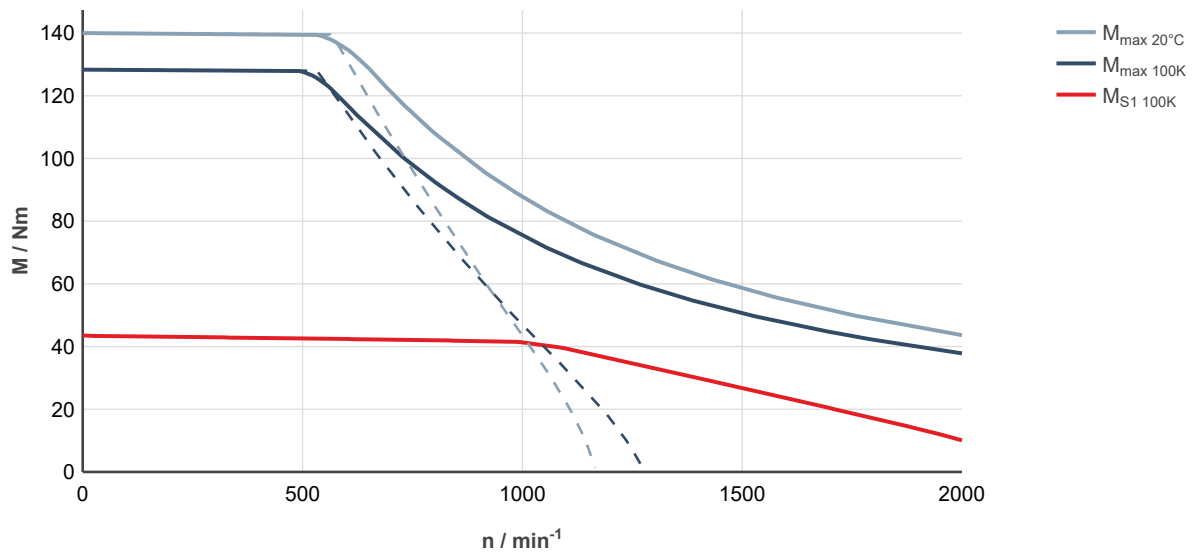

Fig. 157: MS2N07-E1BDA-___0-___-_, ctrlX DRIVE, uncontrolled supply 3 × AC 400 V

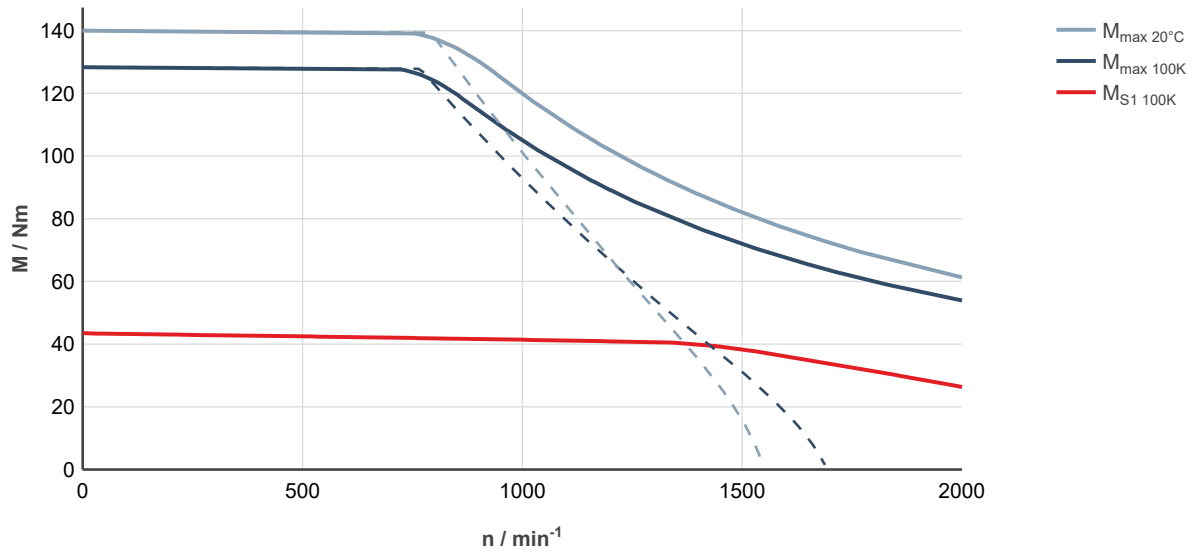

Fig. 158: MS2N07-E1BDA-___0-___-_, ctrlX DRIVE, controlled supply 3 × AC 400 ... 480 V

MS2N07-E1BHA/B

Designation	Symbol	Unit	MS2N07- E1BHA-__0- _N	MS2N07- E1BHA-__2- _N	MS2N07- E1BHB-__0- _N	MS2N07- E1BHB-__2- _N
Standstill torque - 100K ¹⁾	M _{0 100K}	Nm	43.5			
Standstill current - 100K	I _{0 100K}	A	15.2			
Moment of inertia of rotor ¹⁾	J _{rot}	kg*m ²	0.00752	0.00793	0.00752	0.00793
Rated speed - 100K	n _{N 100K}	1/min	1900			
Rated torque - 100K ¹⁾	M _{N 100K}	Nm	36.4			
Rated current - 100K	I _{N 100K}	A	13.2			
Rated power - 100K ¹⁾	P _{N 100K}	kW	7.3			
Maximum torque 20 °C (cold) ¹⁾	M _{max 20°C}	Nm	140			
Maximum torque 100K (warm) ¹⁾	M _{max 100K}	Nm	128.5			
Maximum current	I _{max(rms)}	A	54.1			
Maximum speed (electrical)	n _{max el}	1/min	4000			
Maximum speed (mechanical)	n _{max mech}	1/min	6000			
Number of pole pairs	p		5			
Torque constant at 20 °C ¹⁾	K _m	Nm/A	3.08			
Voltage constant at 20 °C ¹⁾	K _E	V/1000 min ⁻¹	187			
Winding resistance at 20 °C	R ₁₂	Ohm	1.31			
Winding inductance	L _{12_min}	mH	12.1			
Leakage capacitance of the component	C _{ab}	nF	4.77			
Thermal time constant of winding	T _{th_W}	s	43.0			
Thermal time constant of motor	T _{th_M}	min	12.5			
Mass	m _{mot}	kg	26	29	26	29
Holding brake						
Holding torque	M ₄	Nm	0	36.00	0	36.00
Rated voltage	U _N	V	0	24	0	24
Rated current	I _N	A	0	0.94	0	0.94
Maximum connection time	t ₁	ms	0	60	0	60
Maximum disconnection time	t ₂	ms	0	200	0	200
Fan data						
Rated voltage	U _N	V	230		115	
Rated current	I _N	A	0.20/0.18		0.45	
Frequency	f _N	Hz	50/60		60	
1) For tolerance details refer to chapter 6.4 Tolerances			Latest amendment: 2019-02-11			

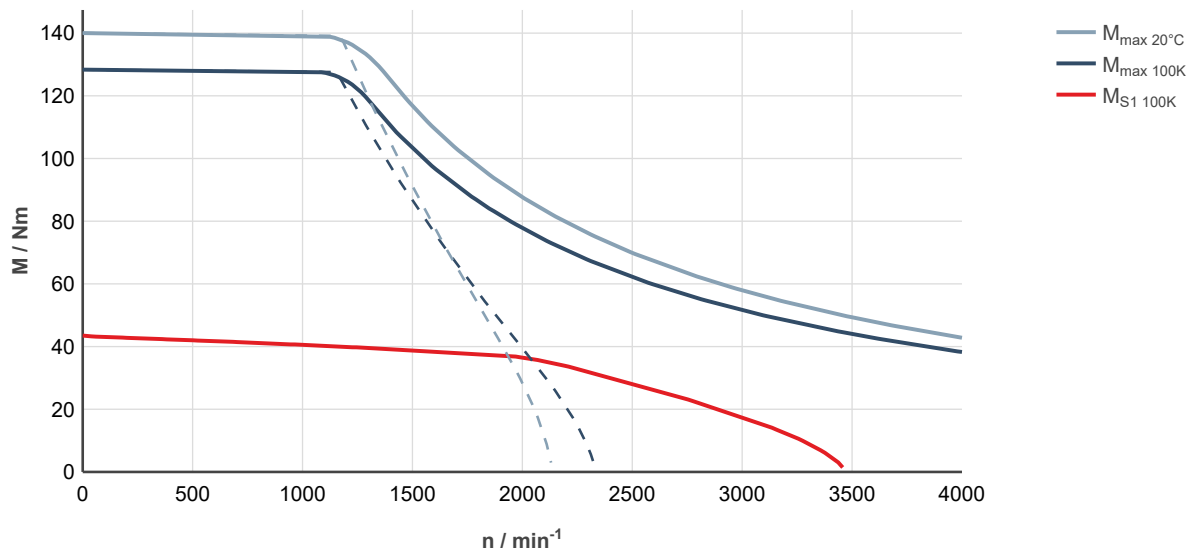

Fig. 159: MS2N07-E1BHA-___0-___-_, ctrlX DRIVE, uncontrolled supply 3 × AC 400 V

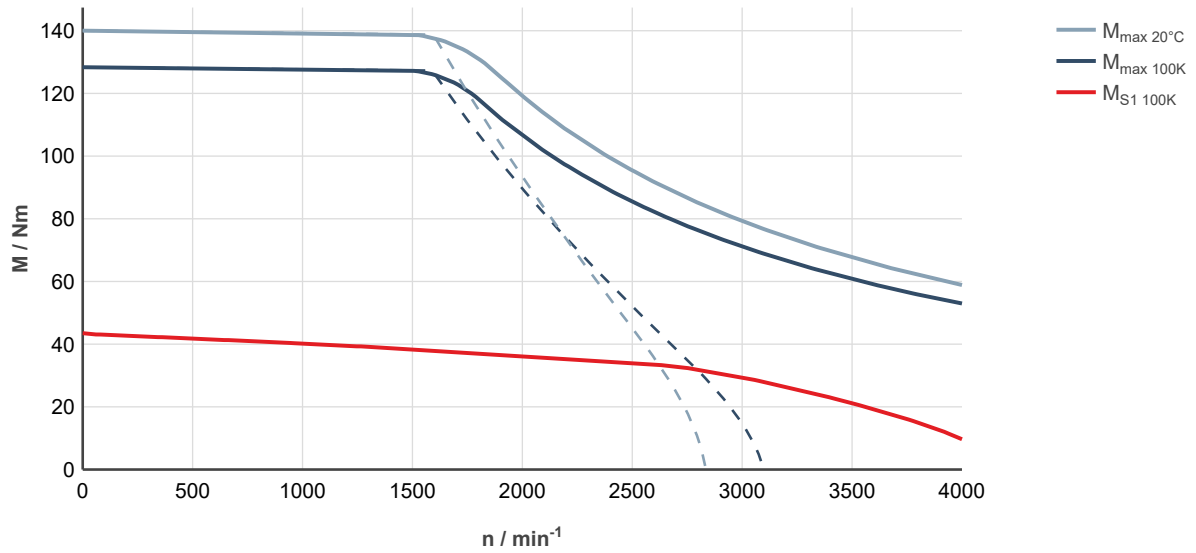

Fig. 160: MS2N07-E1BHA-___0-___-_, ctrlX DRIVE, controlled supply 3 × AC 400 ... 480 V

MS2N07-E1BNA/B

Designation	Symbol	Unit	MS2N07- E1BNA-__0- _N			
			MS2N07- E1BNA-__2- _N	MS2N07- E1BNA-__2- _N	MS2N07- E1BNB-__0- _N	MS2N07- E1BNB-__2- _N
Standstill torque - 100K ¹⁾	M _{0 100K}	Nm	43.5			
Standstill current - 100K	I _{0 100K}	A	23.9			
Moment of inertia of rotor ¹⁾	J _{rot}	kg*m ²	0.00752	0.00793	0.00752	0.00793
Rated speed - 100K	n _{N 100K}	1/min	3100			
Rated torque - 100K ¹⁾	M _{N 100K}	Nm	26.9			
Rated current - 100K	I _{N 100K}	A	15.6			
Rated power - 100K ¹⁾	P _{N 100K}	kW	8.75			
Maximum torque 20 °C (cold) ¹⁾	M _{max 20°C}	Nm	140			
Maximum torque 100K (warm) ¹⁾	M _{max 100K}	Nm	128.5			
Maximum current	I _{max(rms)}	A	85.4			
Maximum speed (electrical)	n _{max el}	1/min	6000			
Maximum speed (mechanical)	n _{max mech}	1/min	6000			
Number of pole pairs	p		5			
Torque constant at 20 °C ¹⁾	K _m	Nm/A	1.96			
Voltage constant at 20 °C ¹⁾	K _E	V/1000 min ⁻¹	119.0			
Winding resistance at 20 °C	R ₁₂	Ohm	0.532			
Winding inductance	L _{12_min}	mH	5.12			
Leakage capacitance of the component	C _{ab}	nF	4.65			
Thermal time constant of winding	T _{th_W}	s	43.0			
Thermal time constant of motor	T _{th_M}	min	12.5			
Mass	m _{mot}	kg	26	29	26	29
Holding brake						
Holding torque	M ₄	Nm	0	36.00	0	36.00
Rated voltage	U _N	V	0	24	0	24
Rated current	I _N	A	0	0.94	0	0.94
Maximum connection time	t ₁	ms	0	60	0	60
Maximum disconnection time	t ₂	ms	0	200	0	200
Fan data						
Rated voltage	U _N	V	230		115	
Rated current	I _N	A	0.20/0.18		0.45	
Frequency	f _N	Hz	50/60		60	
1) For tolerance details refer to chapter 6.4 Tolerances			Latest amendment: 2020-06-03			

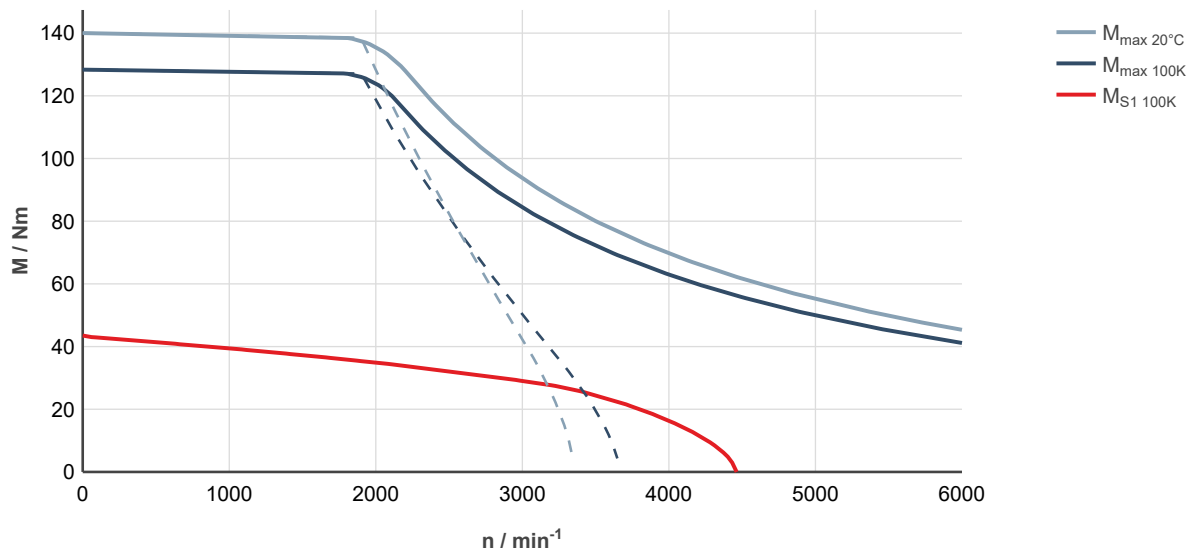

Fig. 161: MS2N07-E1BNA-___0-___-__, ctrlX DRIVE, uncontrolled supply 3 × AC 400 V

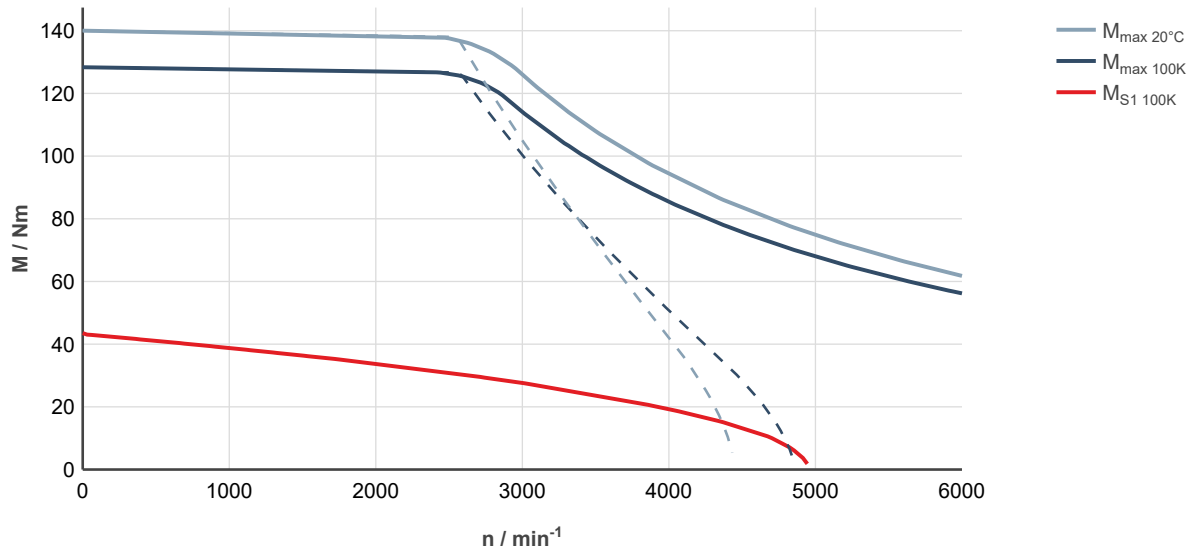

Fig. 162: MS2N07-E1BNA-___0-___-__, ctrlX DRIVE, controlled supply 3 × AC 400 ... 480 V

7.5.3 Water cooling

MS2N07-C0BNL

Designation	Symbol	Unit	MS2N07-C0BNL-__0-N	MS2N07-C0BNL-__1-N
Standstill torque - 100K ¹⁾	M _{0 100K}	Nm	26.6	
Standstill current - 100K	I _{0 100K}	A	15.3	
Moment of inertia of rotor ¹⁾	J _{rot}	kg*m ²	0.0012	0.00146
Rated speed - 100K	n _{N 100K}	1/min	2,100	
Rated torque - 100K ¹⁾	M _{N 100K}	Nm	23.4	
Rated current - 100K	I _{N 100K}	A		
Rated power - 100K ¹⁾	P _{N 100K}	kW	5.15	
Maximum torque 20 °C (cold) ¹⁾	M _{max 20°C}	Nm	38.8	
Maximum torque 100K (warm) ¹⁾	M _{max 100K}	Nm	35.7	
Maximum current	I _{max(eff)}	A	24.8	
Maximum speed (electrical)	n _{max el}	1/min	6,000	
Maximum speed (mechanical)	n _{max mech}	1/min	6,000	
Number of pole pairs	p		5	
Torque constant at 20 °C ¹⁾	K _m	Nm/A	2.01	
Voltage constant at 20 °C ¹⁾	K _E	V/1000 min ⁻¹	122.0	
Winding resistance at 20 °C	R ₁₂	Ohm	1.58	
Winding inductance	L _{12,min}	mH	23.2	
Leakage capacitance of the component	C _{ab}	nF	2.42	
Thermal time constant of winding	T _{th,W}	s	39.4	
Thermal time constant of motor	T _{th,M}	min	4.0	
Mass	m _{mot}	kg	14.0	16.0
Holding brake				
Holding torque	M ₄	Nm	0	20.00
Rated voltage	U _N	V	0	24
Rated current	I _N	A	0	0.78
Maximum connection time	t ₁	ms	0	40
Maximum disconnection time	t ₂	ms	0	100
Water cooling				
Power loss	P _V	kW	0.8	
Coolant inlet temperature	T _{in}	°C	10 ... 40	
Permissible coolant temperature increase for P _V	ΔT _{max}	K	8.0	
Required coolant flow for P _V	Q _{min}	l/min	1.45	
Pressure drop at Q _{min}	Δp	bar	0.10	
Maximum permissible inlet pressure	p _{max}	bar	6.0	
Volume of coolant duct	V _{cool}	l	0.10	
Material of coolant duct			Stainless steel	
1) For tolerance details refer to chapter 6.4 Tolerances			Latest amendment: 2022-06-05	

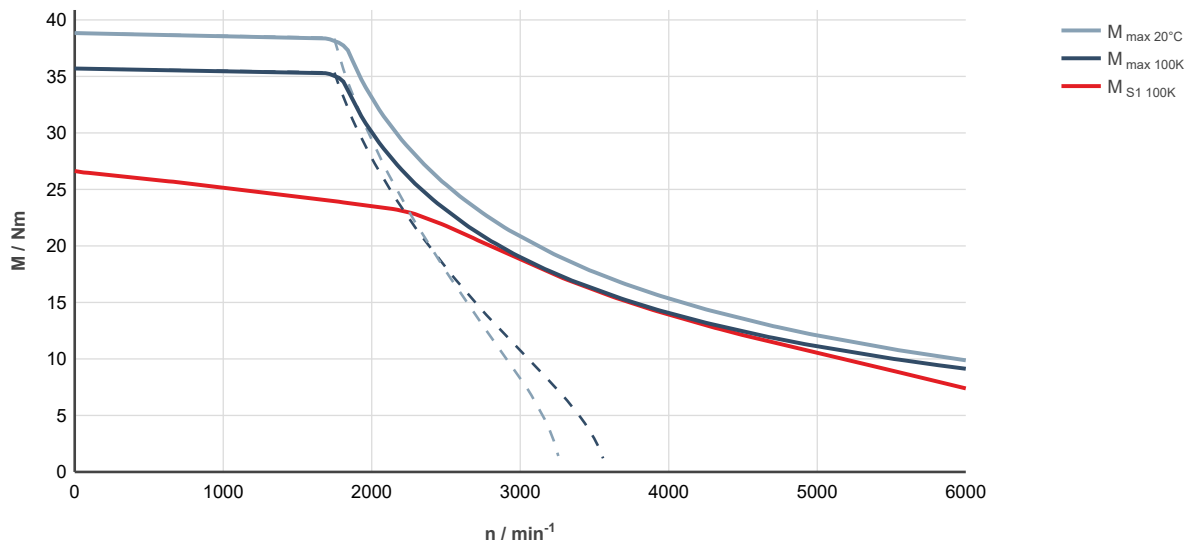

Fig. 163: MS2N07-C0BNL-___0-___-___, ctrIX DRIVE, uncontrolled supply 3 x AC 400 V

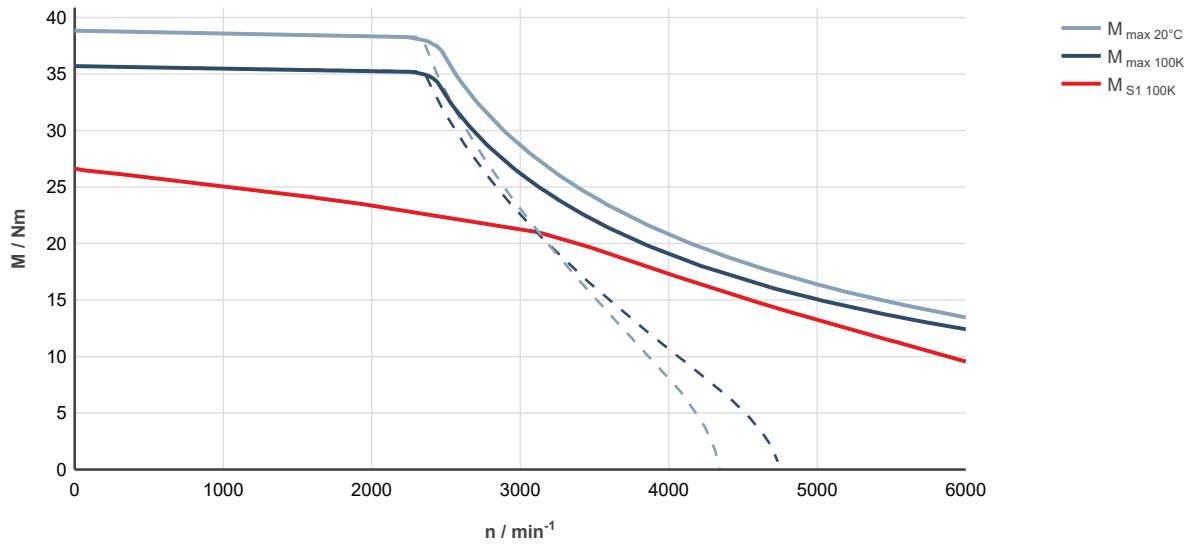

Fig. 164: MS2N07-C0BNL-___0-___-___, ctrIX DRIVE, controlled supply 3 x AC 400 ... 480 V

MS2N07-C0BQL

Designation	Symbol	Unit	MS2N07-C0BQL-__0-_N	MS2N07-C0BQL-__1-_N
Standstill torque - 100K ¹⁾	M _{0 100K}	Nm	26.6	
Standstill current - 100K	I _{0 100K}	A	22.3	
Moment of inertia of rotor ¹⁾	J _{rot}	kg*m ²	0.0012	0.00146
Rated speed - 100K	n _{N 100K}	1/min	3360	
Rated torque - 100K ¹⁾	M _{N 100K}	Nm	19.9	
Rated current - 100K	I _{N 100K}	A	16.8	
Rated power - 100K ¹⁾	P _{N 100K}	kW	7.0	
Maximum torque 20 °C (cold) ¹⁾	M _{max 20°C}	Nm	38.8	
Maximum torque 100K (warm) ¹⁾	M _{max 100K}	Nm	35.7	
Maximum current	I _{max(eff)}	A	36.4	
Maximum speed (electrical)	n _{max el}	1/min	6,000	
Maximum speed (mechanical)	n _{max mech}	1/min	6,000	
Number of pole pairs	p		5	
Torque constant at 20 °C ¹⁾	K _m	Nm/A	1.37	
Voltage constant at 20 °C ¹⁾	K _E	V/1000 min ⁻¹	83.1	
Winding resistance at 20 °C	R ₁₂	Ohm	0.776	
Winding inductance	L _{12,min}	mH	10.5	
Leakage capacitance of the component	C _{ab}	nF	2.2	
Thermal time constant of winding	T _{th,W}	s	39.4	
Thermal time constant of motor	T _{th,M}	min	4.0	
Mass	m _{mot}	kg	14.0	16.0
Holding brake				
Holding torque	M ₄	Nm	0	20.00
Rated voltage	U _N	V	0	24
Rated current	I _N	A	0	0.78
Maximum connection time	t ₁	ms	0	40
Maximum disconnection time	t ₂	ms	0	100
Water cooling				
Power loss	P _V	kW	0.8	
Coolant inlet temperature	T _{in}	°C	10 ... 40	
Permissible coolant temperature increase for P _V	ΔT _{max}	K	8.0	
Required coolant flow for P _V	Q _{min}	l/min	1.45	
Pressure drop at Q _{min}	Δp	bar	0.10	
Maximum permissible inlet pressure	p _{max}	bar	6.0	
Volume of coolant duct	V _{cool}	l	0.10	
Material of coolant duct			Stainless steel	
1) For tolerance details refer to chapter 6.4 Tolerances			Latest amendment: 2019-02-08	

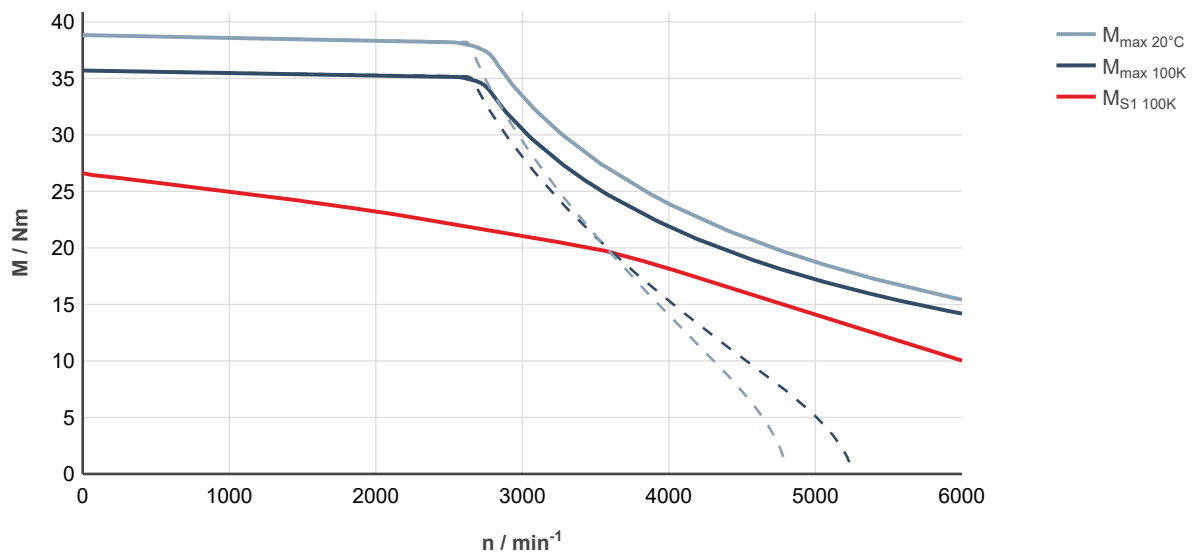

Fig. 165: MS2N07-C0BQL-___0-___-__, ctrlX DRIVE, uncontrolled supply 3 × AC 400 V

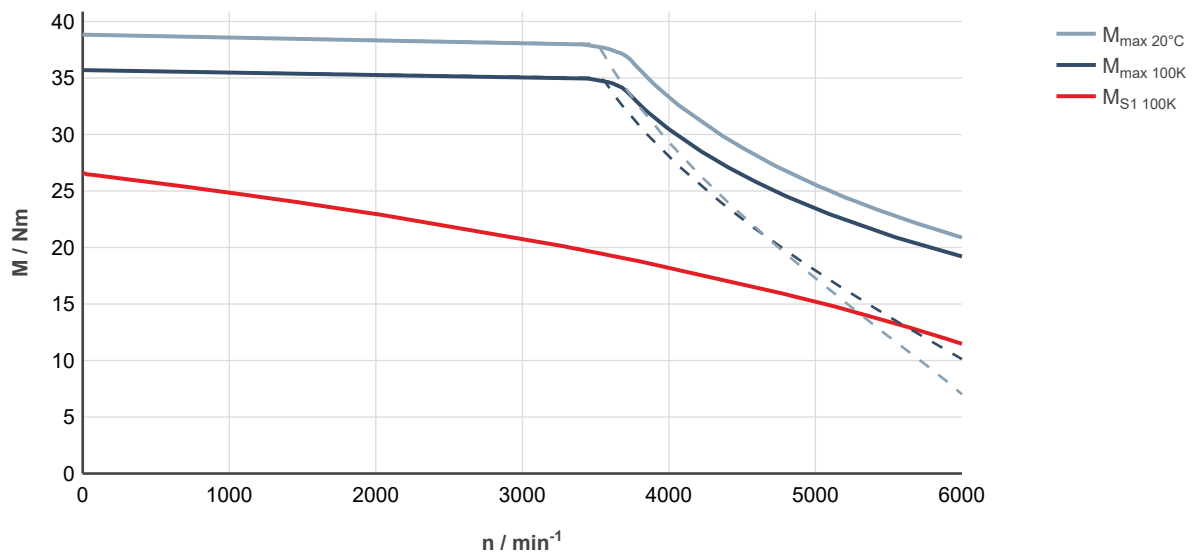

Fig. 166: MS2N07-C0BQL-___0-___-__, ctrlX DRIVE, controlled supply 3 × AC 400 ... 480 V

MS2N07-C1BRL

Designation	Symbol	Unit	MS2N07-C1BRL-__0-N	MS2N07-C1BRL-__1-N
Standstill torque - 100K ¹⁾	$M_{0\ 100K}$	Nm	25.0	
Standstill current - 100K	$I_{0\ 100K}$	A	20.8	
Moment of inertia of rotor ¹⁾	J_{rot}	kg*m ²	0.00305	0.00331
Rated speed - 100K	$n_{N\ 100K}$	1/min	4090	
Rated torque - 100K ¹⁾	$M_{N\ 100K}$	Nm	17.4	
Rated current - 100K	$I_{N\ 100K}$	A	15.1	
Rated power - 100K ¹⁾	$P_{N\ 100K}$	kW	7.45	
Maximum torque 20 °C (cold) ¹⁾	$M_{max\ 20°C}$	Nm	46.0	
Maximum torque 100K (warm) ¹⁾	$M_{max\ 100K}$	Nm	42.2	
Maximum current	$I_{max(rms)}$	A	42.7	
Maximum speed (electrical)	$n_{max\ el}$	1/min	6000	
Maximum speed (mechanical)	$n_{max\ mech}$	1/min	6000	
Number of pole pairs	p		5	
Torque constant at 20 °C ¹⁾	K_m	Nm/A	1.3	
Voltage constant at 20 °C ¹⁾	K_E	V/1000 min ⁻¹	78.7	
Winding resistance at 20 °C	R_{12}	Ohm	0.895	
Winding inductance	L_{12_min}	mH	7.28	
Leakage capacitance of the component	C_{ab}	nF	1.65	
Thermal time constant of winding	T_{th_W}	s	34.5	
Thermal time constant of motor	T_{th_M}	min	4.0	
Mass	m_{mot}	kg	13.5	15.5
Holding brake				
Holding torque	M_4	Nm	0	20.00
Rated voltage	U_N	V	0	24
Rated current	I_N	A	0	0.78
Maximum connection time	t_1	ms	0	40
Maximum disconnection time	t_2	ms	0	100
Water cooling				
Power loss	P_V	kW	0.8	
Coolant inlet temperature	T_{in}	°C	10 ... 40	
Permissible coolant temperature increase for P_V	ΔT_{max}	K	8.0	
Required coolant flow for P_V	Q_{min}	l/min	1.45	
Pressure drop at Q_{min}	Δp	bar	0.10	
Maximum permissible inlet pressure	p_{max}	bar	6.0	
Volume of coolant duct	V_{cool}	l	0.10	
Material of coolant duct			Stainless steel	
1) For tolerance details refer to chapter 6.4 Tolerances			Latest amendment: 2019-02-08	

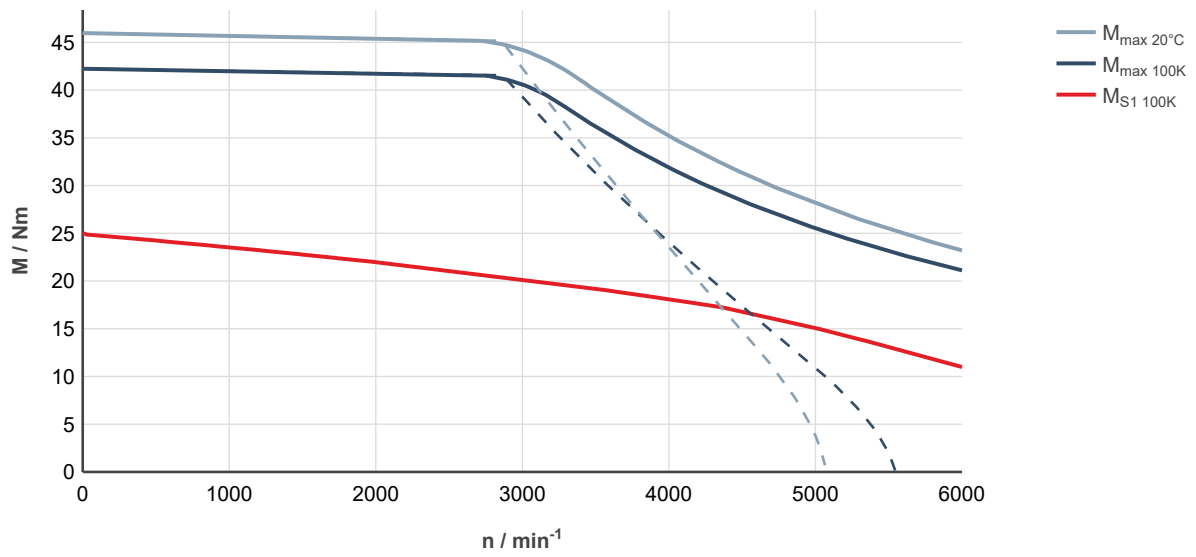

Fig. 167: MS2N07-C1BRL-___0-___-__, ctrlX DRIVE, uncontrolled supply 3 × AC 400 V

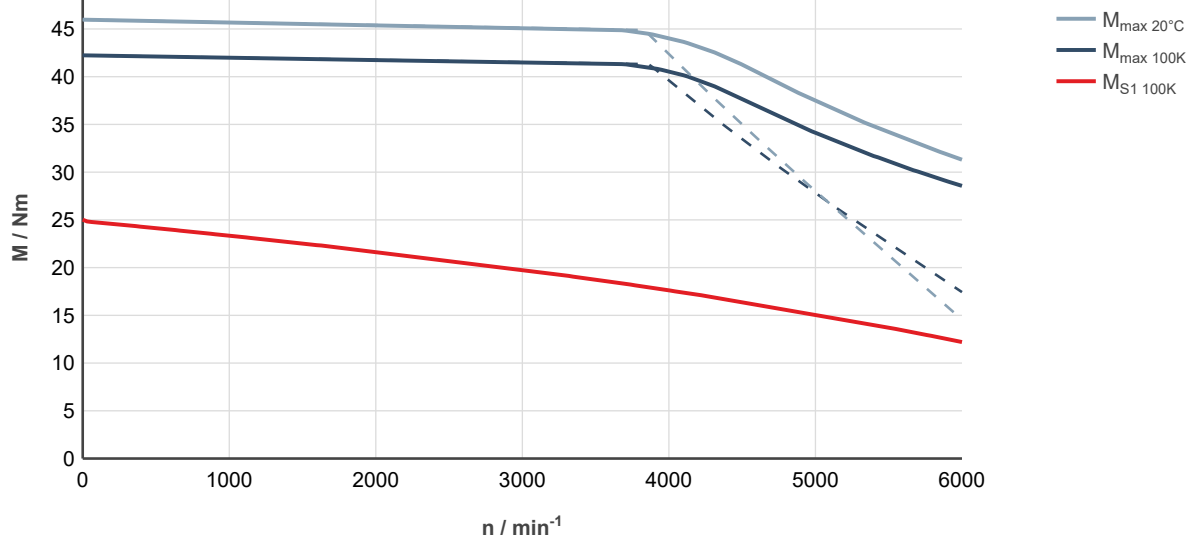

Fig. 168: MS2N07-C1BRL-___0-___-__, ctrlX DRIVE, controlled supply 3 × AC 400 ... 480 V

MS2N07-D0BHL

Designation	Symbol	Unit	MS2N07-D0BHL-__0-_N	MS2N07-D0BHL-__2-_N
Standstill torque - 100K ¹⁾	$M_{0\ 100K}$	Nm	55.0	
Standstill current - 100K	$I_{0\ 100K}$	A	22.8	
Moment of inertia of rotor ¹⁾	J_{rot}	kg*m ²	0.0021	0.00251
Rated speed - 100K	$n_{N\ 100K}$	1/min	1550	
Rated torque - 100K ¹⁾	$M_{N\ 100K}$	Nm	48.4	
Rated current - 100K	$I_{N\ 100K}$	A	20.2	
Rated power - 100K ¹⁾	$P_{N\ 100K}$	kW	7.85	
Maximum torque 20 °C (cold) ¹⁾	$M_{max\ 20°C}$	Nm	79.7	
Maximum torque 100K (warm) ¹⁾	$M_{max\ 100K}$	Nm	73.2	
Maximum current	$I_{max(rms)}$	A	36.4	
Maximum speed (electrical)	$n_{max\ el}$	1/min	4000	
Maximum speed (mechanical)	$n_{max\ mech}$	1/min	6000	
Number of pole pairs	p		5	
Torque constant at 20 °C ¹⁾	K_m	Nm/A	2.76	
Voltage constant at 20 °C ¹⁾	K_E	V/1000 min ⁻¹	167.5	
Winding resistance at 20 °C	R_{12}	Ohm	1.30	
Winding inductance	L_{12_min}	mH	20.2	
Leakage capacitance of the component	C_{ab}	nF	4.1	
Thermal time constant of winding	T_{th_W}	s	45.8	
Thermal time constant of motor	T_{th_M}	min	4.2	
Mass	m_{mot}	kg	19.5	22.0
Holding brake				
Holding torque	M_4	Nm	0	36.00
Rated voltage	U_N	V	0	24
Rated current	I_N	A	0	0.94
Maximum connection time	t_1	ms	0	60
Maximum disconnection time	t_2	ms	0	200
Water cooling				
Power loss	P_V	kW	1.4	
Coolant inlet temperature	T_{in}	°C	10 ... 40	
Permissible coolant temperature increase for P_V	ΔT_{max}	K	8.0	
Required coolant flow for P_V	Q_{min}	l/min	2.51	
Pressure drop at Q_{min}	Δp	bar	0.16	
Maximum permissible inlet pressure	p_{max}	bar	6.0	
Volume of coolant duct	V_{cool}	l	0.20	
Material of coolant duct			Stainless steel	
1) For tolerance details refer to chapter 6.4 Tolerances			Latest amendment: 2019-02-08	

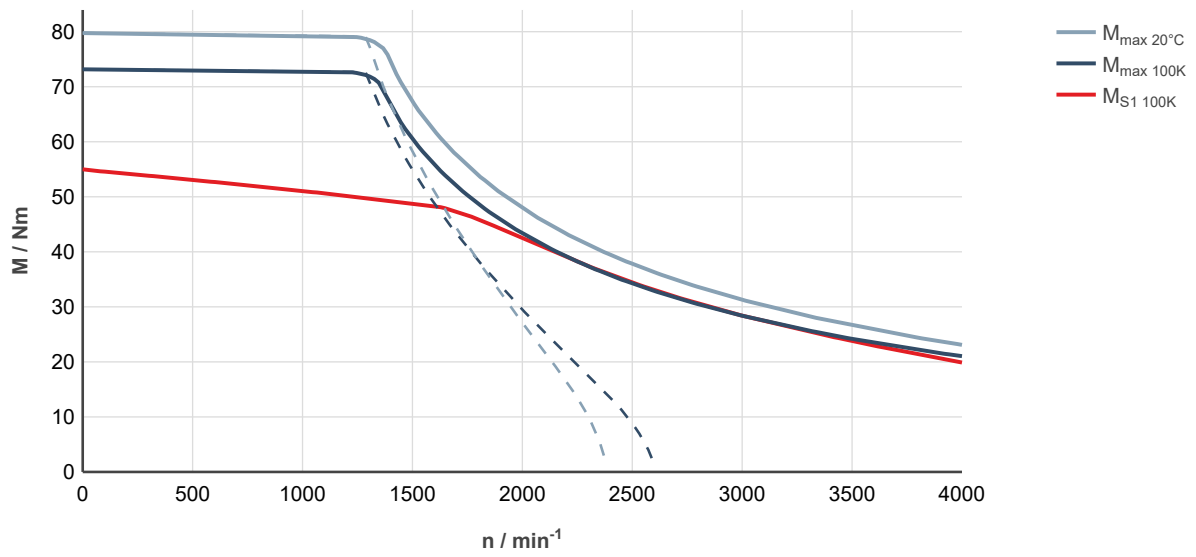

Fig. 169: MS2N07-D0BHL-___0-___-___, ctrIX DRIVE, uncontrolled supply 3 × AC 400 V

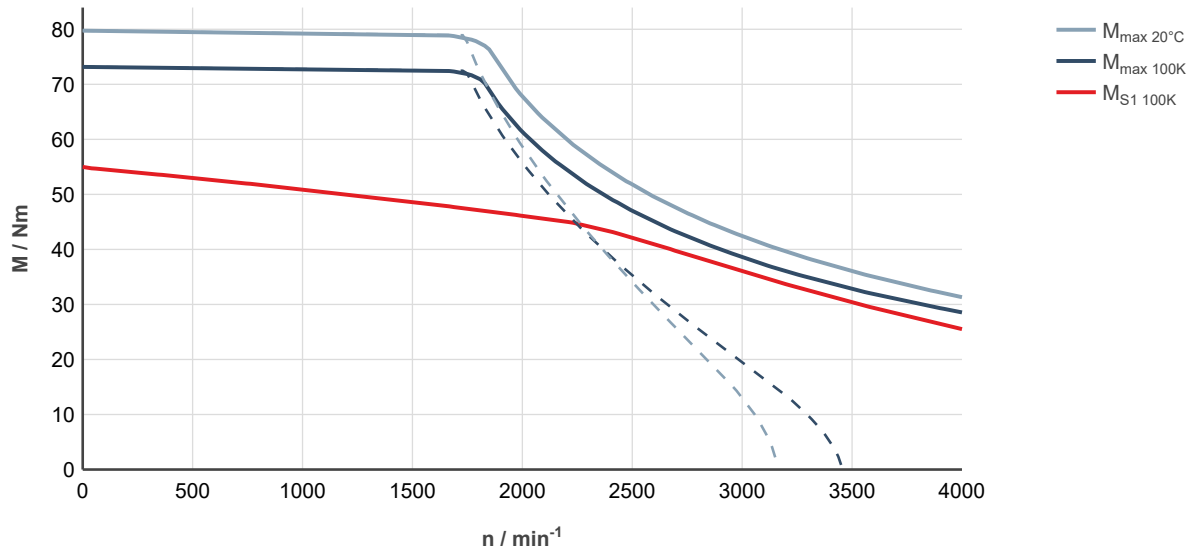

Fig. 170: MS2N07-D0BHL-___0-___-___, ctrIX DRIVE, controlled supply 3 × AC 400 ... 480 V

MS2N07-D0BNL

Designation	Symbol	Unit	MS2N07-D0BNL-__0-N	MS2N07-D0BNL-__2-N
Standstill torque - 100K ¹⁾	$M_{0\ 100K}$	Nm	55.0	
Standstill current - 100K	$I_{0\ 100K}$	A	31.0	
Moment of inertia of rotor ¹⁾	J_{rot}	kg*m ²	0.0021	0.00251
Rated speed - 100K	$n_{N\ 100K}$	1/min	2100	
Rated torque - 100K ¹⁾	$M_{N\ 100K}$	Nm	45.0	
Rated current - 100K	$I_{N\ 100K}$	A	25.5	
Rated power - 100K ¹⁾	$P_{N\ 100K}$	kW	9.9	
Maximum torque 20 °C (cold) ¹⁾	$M_{max\ 20°C}$	Nm	79.7	
Maximum torque 100K (warm) ¹⁾	$M_{max\ 100K}$	Nm	73.2	
Maximum current	$I_{max(rms)}$	A	49.5	
Maximum speed (electrical)	$n_{max\ el}$	1/min	6000	
Maximum speed (mechanical)	$n_{max\ mech}$	1/min	6000	
Number of pole pairs	p		5	
Torque constant at 20 °C ¹⁾	K_m	Nm/A	2.04	
Voltage constant at 20 °C ¹⁾	K_E	V/1000 min ⁻¹	124.1	
Winding resistance at 20 °C	R_{12}	Ohm	0.671	
Winding inductance	L_{12_min}	mH	10.0	
Leakage capacitance of the component	C_{ab}	nF	4.0	
Thermal time constant of winding	T_{th_W}	s	45.8	
Thermal time constant of motor	T_{th_M}	min	4.2	
Mass	m_{mot}	kg	19.5	22.0
Holding brake				
Holding torque	M_4	Nm	0	36.00
Rated voltage	U_N	V	0	24
Rated current	I_N	A	0	0.94
Maximum connection time	t_1	ms	0	60
Maximum disconnection time	t_2	ms	0	200
Water cooling				
Power loss	P_V	kW	1.4	
Coolant inlet temperature	T_{in}	°C	10 ... 40	
Permissible coolant temperature increase for P_V	ΔT_{max}	K	8.0	
Required coolant flow for P_V	Q_{min}	l/min	2.51	
Pressure drop at Q_{min}	Δp	bar	0.16	
Maximum permissible inlet pressure	p_{max}	bar	6.0	
Volume of coolant duct	V_{cool}	l	0.20	
Material of coolant duct			Stainless steel	
1) For tolerance details refer to chapter 6.4 Tolerances			Latest amendment: 2019-02-08	

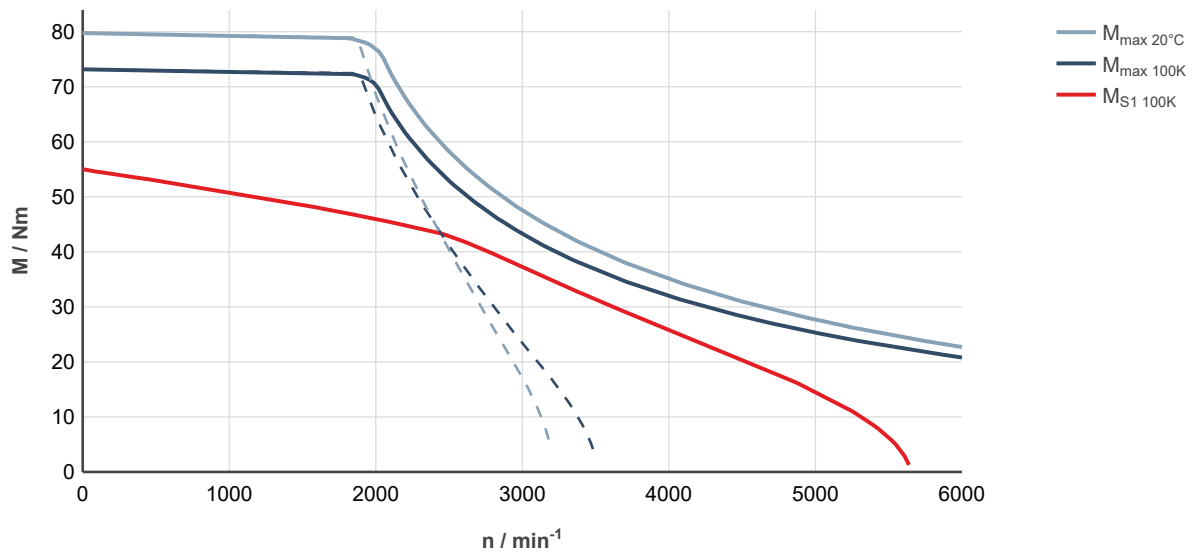

Fig. 171: MS2N07-D0BNL-__0-__-__, ctrlX DRIVE, uncontrolled supply 3 × AC 400 V

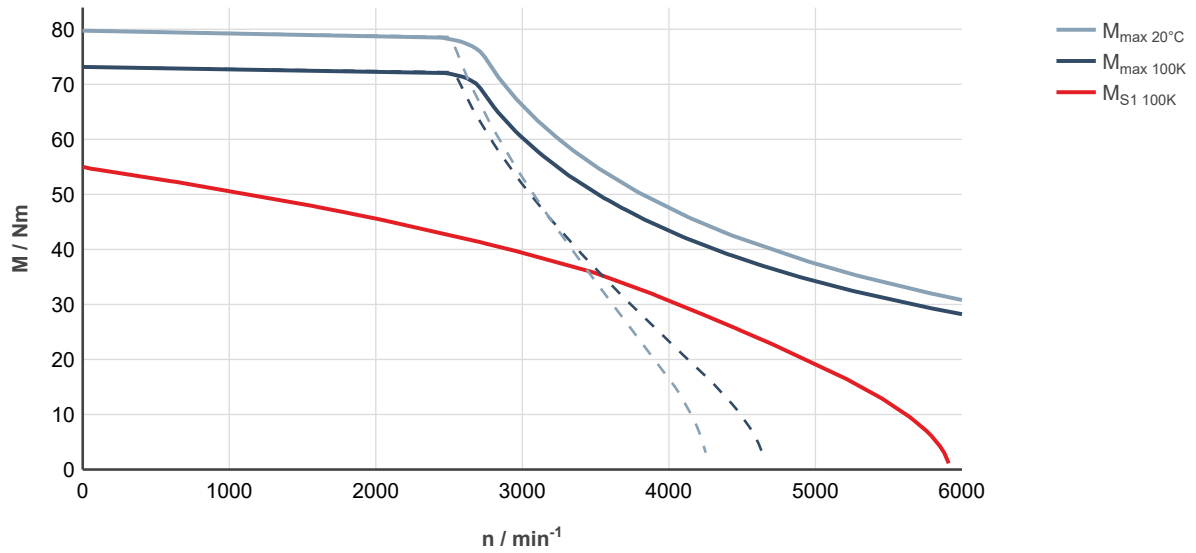

Fig. 172: MS2N07-D0BNL-__0-__-__, ctrlX DRIVE, controlled supply 3 × AC 400 ... 480 V

MS2N07-D0BRL

Designation	Symbol	Unit	MS2N07-D0BRL-__0-_N	MS2N07-D0BRL-__2-_N
Standstill torque - 100K ¹⁾	$M_{0\ 100K}$	Nm	55.0	
Standstill current - 100K	$I_{0\ 100K}$	A	45.8	
Moment of inertia of rotor ¹⁾	J_{rot}	kg*m ²	0.0021	0.00251
Rated speed - 100K	$n_{N\ 100K}$	1/min	3650	
Rated torque - 100K ¹⁾	$M_{N\ 100K}$	Nm	33.2	
Rated current - 100K	$I_{N\ 100K}$	A	27.7	
Rated power - 100K ¹⁾	$P_{N\ 100K}$	kW	12.7	
Maximum torque 20 °C (cold) ¹⁾	$M_{max\ 20°C}$	Nm	79.7	
Maximum torque 100K (warm) ¹⁾	$M_{max\ 100K}$	Nm	73.2	
Maximum current	$I_{max(rms)}$	A	72.7	
Maximum speed (electrical)	$n_{max\ el}$	1/min	6000	
Maximum speed (mechanical)	$n_{max\ mech}$	1/min	6000	
Number of pole pairs	p		5	
Torque constant at 20 °C ¹⁾	K_m	Nm/A	1.38	
Voltage constant at 20 °C ¹⁾	K_E	V/1000 min ⁻¹	83.9	
Winding resistance at 20 °C	R_{12}	Ohm	0.327	
Winding inductance	L_{12_min}	mH	5.06	
Leakage capacitance of the component	C_{ab}	nF	3.95	
Thermal time constant of winding	T_{th_W}	s	45.8	
Thermal time constant of motor	T_{th_M}	min	4.2	
Mass	m_{mot}	kg	19.5	22.0
Holding brake				
Holding torque	M_4	Nm	0	36.00
Rated voltage	U_N	V	0	24
Rated current	I_N	A	0	0.94
Maximum connection time	t_1	ms	0	60
Maximum disconnection time	t_2	ms	0	200
Water cooling				
Power loss	P_V	kW	1.4	
Coolant inlet temperature	T_{in}	°C	10 ... 40	
Permissible coolant temperature increase for P_V	ΔT_{max}	K	8.0	
Required coolant flow for P_V	Q_{min}	l/min	2.51	
Pressure drop at Q_{min}	Δp	bar	0.16	
Maximum permissible inlet pressure	p_{max}	bar	6.0	
Volume of coolant duct	V_{cool}	l	0.20	
Material of coolant duct			Stainless steel	
1) For tolerance details refer to chapter 6.4 Tolerances			Latest amendment: 2019-02-08	

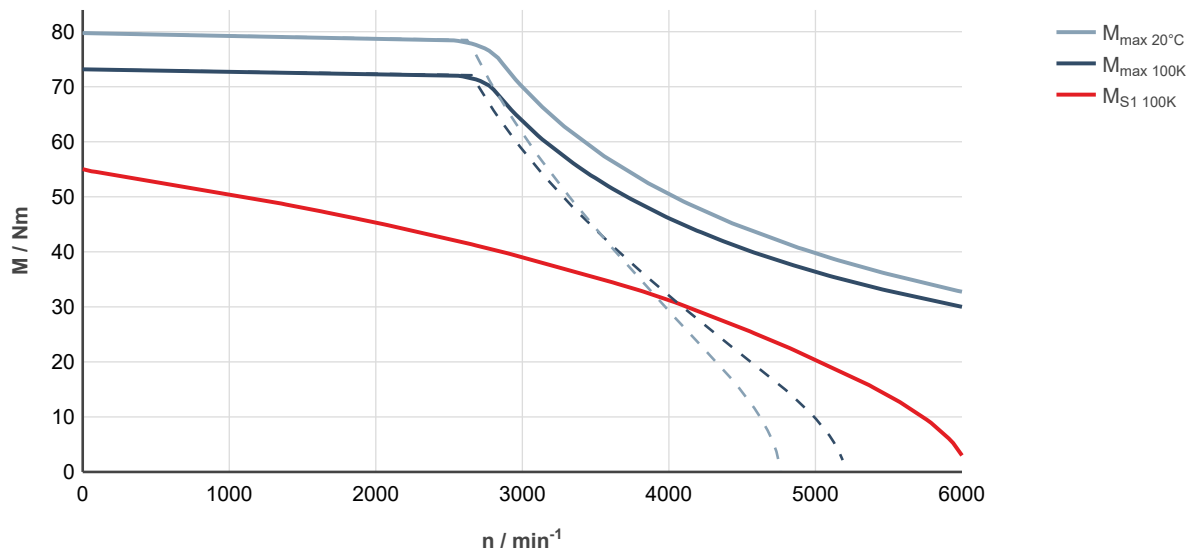

Fig. 173: MS2N07-D0BRL-___0-___-___, ctrlX DRIVE, uncontrolled supply 3 × AC 400 V

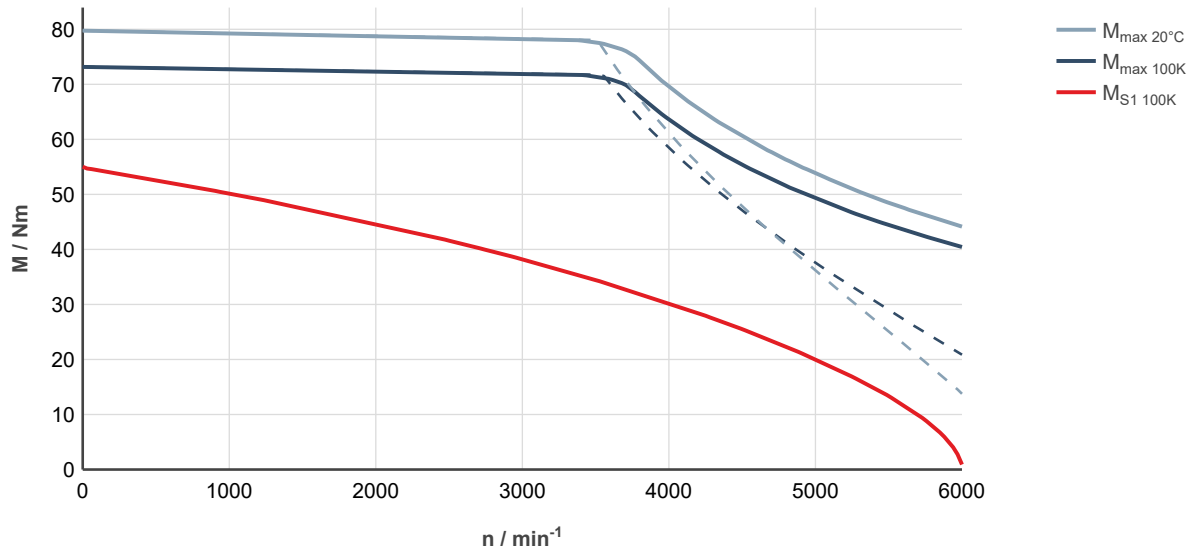

Fig. 174: MS2N07-D0BRL-___0-___-___, ctrlX DRIVE, controlled supply 3 × AC 400 ... 480 V

MS2N07-D1BNL

Designation	Symbol	Unit	MS2N07-D1BNL-__0-N	MS2N07-D1BNL-__2-N
Standstill torque - 100K ¹⁾	$M_{0\ 100K}$	Nm	50.5	
Standstill current - 100K	$I_{0\ 100K}$	A	26.7	
Moment of inertia of rotor ¹⁾	J_{rot}	kg*m ²	0.00529	0.00570
Rated speed - 100K	$n_{N\ 100K}$	1/min	2450	
Rated torque - 100K ¹⁾	$M_{N\ 100K}$	Nm	41.7	
Rated current - 100K	$I_{N\ 100K}$	A	22.6	
Rated power - 100K ¹⁾	$P_{N\ 100K}$	kW	10.7	
Maximum torque 20 °C (cold) ¹⁾	$M_{max\ 20°C}$	Nm	92.5	
Maximum torque 100K (warm) ¹⁾	$M_{max\ 100K}$	Nm	84.8	
Maximum current	$I_{max(rms)}$	A	54.1	
Maximum speed (electrical)	$n_{max\ el}$	1/min	6000	
Maximum speed (mechanical)	$n_{max\ mech}$	1/min	6000	
Number of pole pairs	p		5	
Torque constant at 20 °C ¹⁾	K_m	Nm/A	2.05	
Voltage constant at 20 °C ¹⁾	K_E	V/1000 min ⁻¹	124.3	
Winding resistance at 20 °C	R_{12}	Ohm	0.942	
Winding inductance	L_{12_min}	mH	7.9	
Leakage capacitance of the component	C_{ab}	nF	3.0	
Thermal time constant of winding	T_{th_W}	s	38.9	
Thermal time constant of motor	T_{th_M}	min	4.2	
Mass	m_{mot}	kg	20.0	23
Holding brake				
Holding torque	M_4	Nm	0	36.00
Rated voltage	U_N	V	0	24
Rated current	I_N	A	0	0.94
Maximum connection time	t_1	ms	0	60
Maximum disconnection time	t_2	ms	0	200
Water cooling				
Power loss	P_V	kW	1.4	
Coolant inlet temperature	T_{in}	°C	10 ... 40	
Permissible coolant temperature increase for P_V	ΔT_{max}	K	8.0	
Required coolant flow for P_V	Q_{min}	l/min	2.51	
Pressure drop at Q_{min}	Δp	bar	0.16	
Maximum permissible inlet pressure	p_{max}	bar	6.0	
Volume of coolant duct	V_{cool}	l	0.20	
Material of coolant duct			Stainless steel	
1) For tolerance details refer to chapter 6.4 Tolerances			Latest amendment: 2019-02-08	

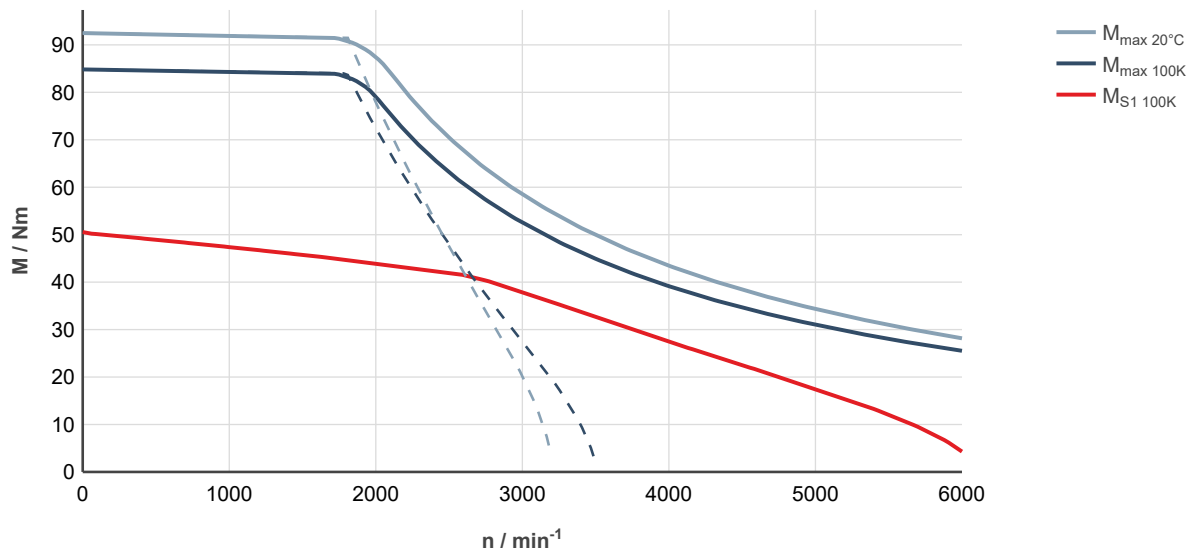

Fig. 175: MS2N07-D1BNL-___0-___-___, ctrIX DRIVE, uncontrolled supply 3 × AC 400 V

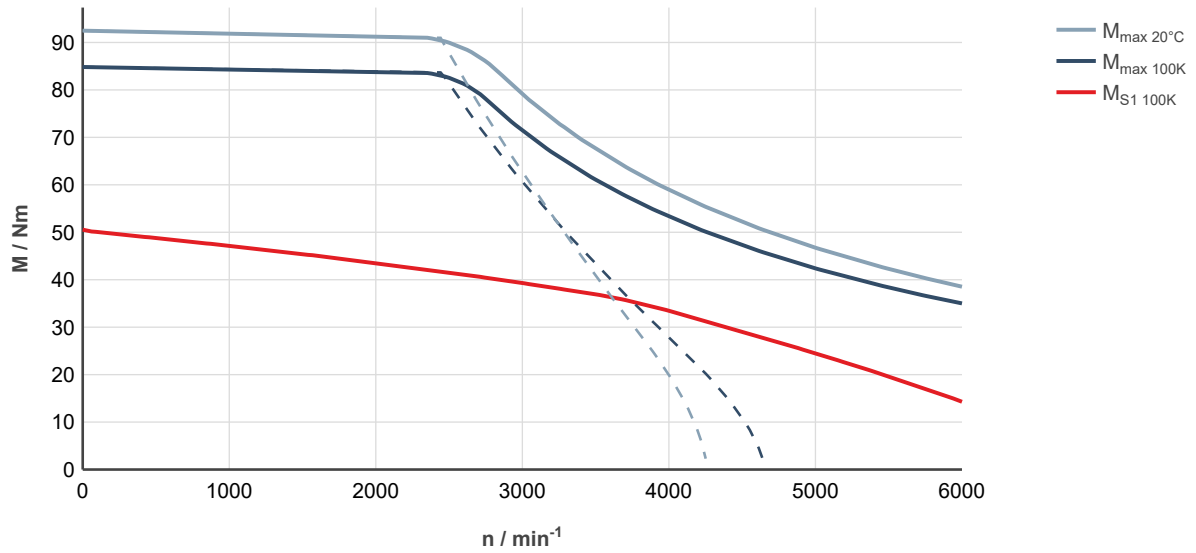

Fig. 176: MS2N07-D1BNL-___0-___-___, ctrIX DRIVE, controlled supply 3 × AC 400 ... 480 V

MS2N07-E0BHL

Designation	Symbol	Unit	MS2N07-E0BHL-__0-_N	MS2N07-E0BHL-__2-_N
Standstill torque - 100K ¹⁾	$M_{0\ 100K}$	Nm	83.0	
Standstill current - 100K	$I_{0\ 100K}$	A	31.5	
Moment of inertia of rotor ¹⁾	J_{rot}	kg*m ²	0.003	0.00341
Rated speed - 100K	$n_{N\ 100K}$	1/min	1400	
Rated torque - 100K ¹⁾	$M_{N\ 100K}$	Nm	73.9	
Rated current - 100K	$I_{N\ 100K}$	A	28.2	
Rated power - 100K ¹⁾	$P_{N\ 100K}$	kW	10.85	
Maximum torque 20 °C (cold) ¹⁾	$M_{max\ 20°C}$	Nm	119.5	
Maximum torque 100K (warm) ¹⁾	$M_{max\ 100K}$	Nm	109.5	
Maximum current	$I_{max(rms)}$	A	49.5	
Maximum speed (electrical)	$n_{max\ el}$	1/min	4000	
Maximum speed (mechanical)	$n_{max\ mech}$	1/min	6000	
Number of pole pairs	p		5	
Torque constant at 20 °C ¹⁾	K_m	Nm/A	3.03	
Voltage constant at 20 °C ¹⁾	K_E	V/1000 min ⁻¹	184.3	
Winding resistance at 20 °C	R_{12}	Ohm	0.95	
Winding inductance	L_{12_min}	mH	14.8	
Leakage capacitance of the component	C_{ab}	nF	7.1	
Thermal time constant of winding	T_{th_W}	s	51.5	
Thermal time constant of motor	T_{th_M}	min	4.4	
Mass	m_{mot}	kg	26	29
Holding brake				
Holding torque	M_4	Nm	0	36.00
Rated voltage	U_N	V	0	24
Rated current	I_N	A	0	0.94
Maximum connection time	t_1	ms	0	60
Maximum disconnection time	t_2	ms	0	200
Water cooling				
Power loss	P_V	kW	2.0	
Coolant inlet temperature	T_{in}	°C	10 ... 40	
Permissible coolant temperature increase for P_V	ΔT_{max}	K	8.0	
Required coolant flow for P_V	Q_{min}	l/min	3.59	
Pressure drop at Q_{min}	Δp	bar	0.30	
Maximum permissible inlet pressure	p_{max}	bar	6.0	
Volume of coolant duct	V_{cool}	l	0.25	
Material of coolant duct			Stainless steel	
1) For tolerance details refer to chapter 6.4 Tolerances			Latest amendment: 2019-02-08	

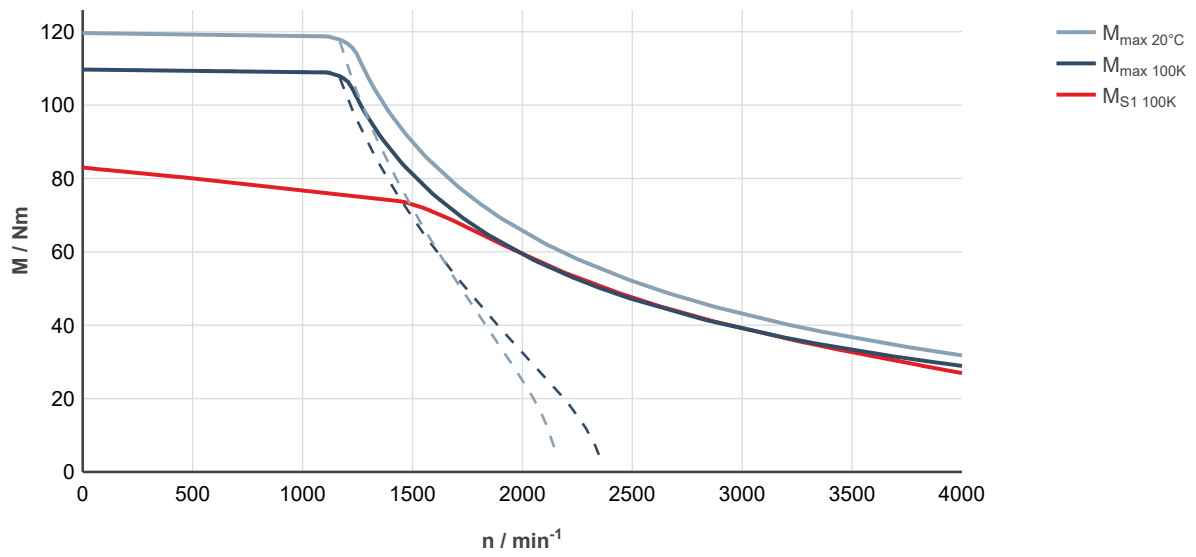

Fig. 177: MS2N07-E0BHL-___0-___-___, ctrlX DRIVE, uncontrolled supply 3 × AC 400 V

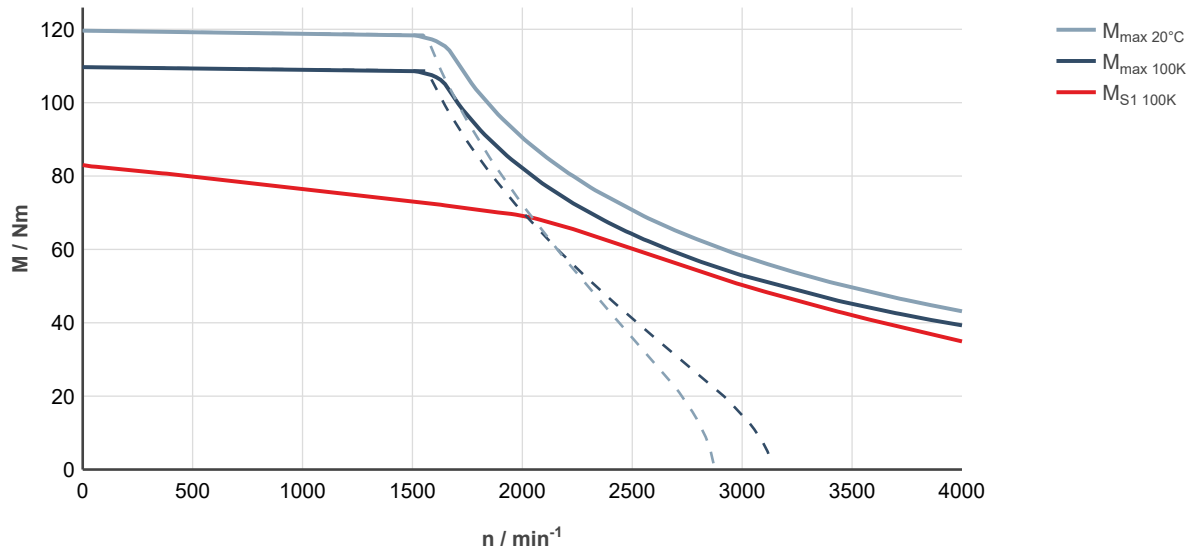

Fig. 178: MS2N07-E0BHL-___0-___-___, ctrlX DRIVE, controlled supply 3 × AC 400 ... 480 V

MS2N07-E0BNL

Designation	Symbol	Unit	MS2N07-E0BNL-__0-N	MS2N07-E0BNL-__2-N
Standstill torque - 100K ¹⁾	$M_{0\ 100K}$	Nm	83.0	
Standstill current - 100K	$I_{0\ 100K}$	A	46.0	
Moment of inertia of rotor ¹⁾	J_{rot}	kg*m ²	0.003	0.00341
Rated speed - 100K	$n_{N\ 100K}$	1/min	2200	
Rated torque - 100K ¹⁾	$M_{N\ 100K}$	Nm	67.0	
Rated current - 100K	$I_{N\ 100K}$	A	37.3	
Rated power - 100K ¹⁾	$P_{N\ 100K}$	kW	15.4	
Maximum torque 20 °C (cold) ¹⁾	$M_{max\ 20°C}$	Nm	119.5	
Maximum torque 100K (warm) ¹⁾	$M_{max\ 100K}$	Nm	109.5	
Maximum current	$I_{max(rms)}$	A	72.7	
Maximum speed (electrical)	$n_{max\ el}$	1/min	6000	
Maximum speed (mechanical)	$n_{max\ mech}$	1/min	6000	
Number of pole pairs	p		5	
Torque constant at 20 °C ¹⁾	K_m	Nm/A	2.08	
Voltage constant at 20 °C ¹⁾	K_E	V/1000 min ⁻¹	126.2	
Winding resistance at 20 °C	R_{12}	Ohm	0.455	
Winding inductance	L_{12_min}	mH	7.50	
Leakage capacitance of the component	C_{ab}	nF	6.11	
Thermal time constant of winding	T_{th_W}	s	51.5	
Thermal time constant of motor	T_{th_M}	min	4.4	
Mass	m_{mot}	kg	26	29
Holding brake				
Holding torque	M_4	Nm	0	36.00
Rated voltage	U_N	V	0	24
Rated current	I_N	A	0	0.94
Maximum connection time	t_1	ms	0	60
Maximum disconnection time	t_2	ms	0	200
Water cooling				
Power loss	P_V	kW	2.0	
Coolant inlet temperature	T_{in}	°C	10 ... 40	
Permissible coolant temperature increase for P_V	ΔT_{max}	K	8.0	
Required coolant flow for P_V	Q_{min}	l/min	3.59	
Pressure drop at Q_{min}	Δp	bar	0.30	
Maximum permissible inlet pressure	p_{max}	bar	6.0	
Volume of coolant duct	V_{cool}	l	0.25	
Material of coolant duct			Stainless steel	
1) For tolerance details refer to chapter 6.4 Tolerances			Latest amendment: 2019-02-08	

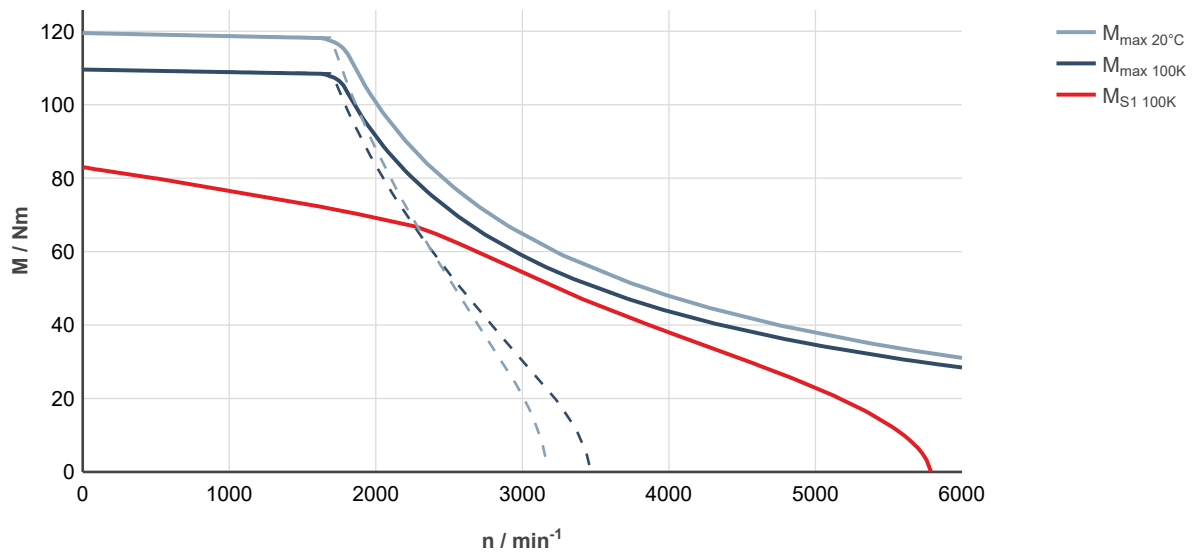

Fig. 179: MS2N07-E0BNL-___0-___-___, ctrlX DRIVE, uncontrolled supply 3 × AC 400 V

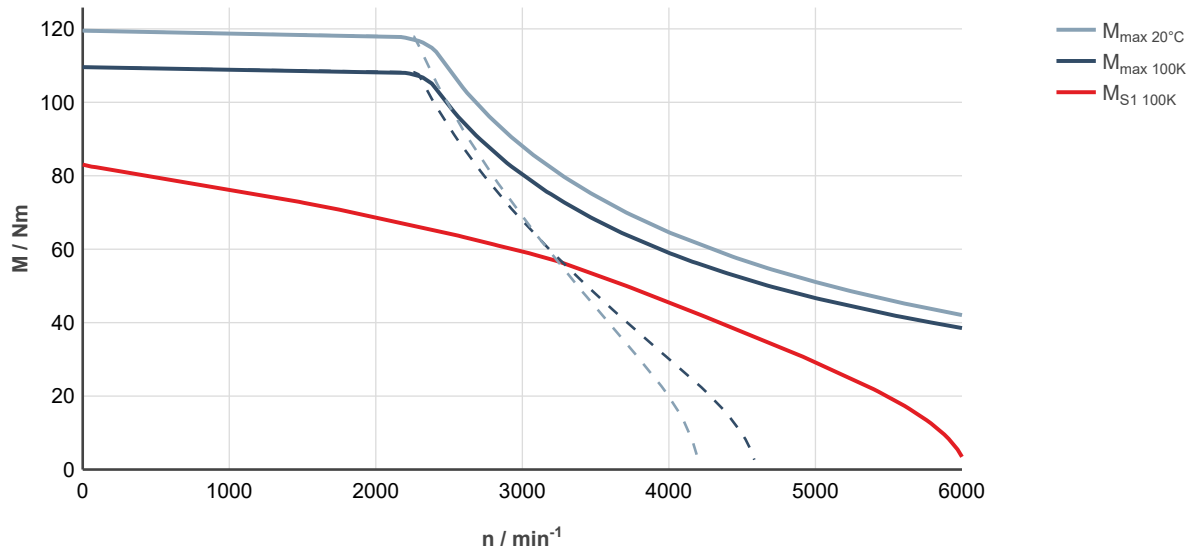

Fig. 180: MS2N07-E0BNL-___0-___-___, ctrlX DRIVE, controlled supply 3 × AC 400 ... 480 V

MS2N07-E0BQL

Designation	Symbol	Unit	MS2N07-E0BQL-__0-N	MS2N07-E0BQL-__2-N
Standstill torque - 100K ¹⁾	$M_{0\ 100K}$	Nm	83.0	
Standstill current - 100K	$I_{0\ 100K}$	A	58.3	
Moment of inertia of rotor ¹⁾	J_{rot}	kg*m ²	0.003	0.00341
Rated speed - 100K	$n_{N\ 100K}$	1/min	3000	
Rated torque - 100K ¹⁾	$M_{N\ 100K}$	Nm	55.7	
Rated current - 100K	$I_{N\ 100K}$	A	39.1	
Rated power - 100K ¹⁾	$P_{N\ 100K}$	kW	17.5	
Maximum torque 20 °C (cold) ¹⁾	$M_{max\ 20°C}$	Nm	119.5	
Maximum torque 100K (warm) ¹⁾	$M_{max\ 100K}$	Nm	109.5	
Maximum current	$I_{max(rms)}$	A	92.3	
Maximum speed (electrical)	$n_{max\ el}$	1/min	6000	
Maximum speed (mechanical)	$n_{max\ mech}$	1/min	6000	
Number of pole pairs	p		5	
Torque constant at 20 °C ¹⁾	K_m	Nm/A	1.64	
Voltage constant at 20 °C ¹⁾	K_E	V/1000 min ⁻¹	99.3	
Winding resistance at 20 °C	R_{12}	Ohm	0.282	
Winding inductance	L_{12_min}	mH	4.64	
Leakage capacitance of the component	C_{ab}	nF	6.21	
Thermal time constant of winding	T_{th_W}	s	51.5	
Thermal time constant of motor	T_{th_M}	min	4.4	
Mass	m_{mot}	kg	26	29
Holding brake				
Holding torque	M_4	Nm	0	36.00
Rated voltage	U_N	V	0	24
Rated current	I_N	A	0	0.94
Maximum connection time	t_1	ms	0	60
Maximum disconnection time	t_2	ms	0	200
Water cooling				
Power loss	P_V	kW	2.0	
Coolant inlet temperature	T_{in}	°C	10 ... 40	
Permissible coolant temperature increase for P_V	ΔT_{max}	K	8.0	
Required coolant flow for P_V	Q_{min}	l/min	3.59	
Pressure drop at Q_{min}	Δp	bar	0.30	
Maximum permissible inlet pressure	p_{max}	bar	6.0	
Volume of coolant duct	V_{cool}	l	0.25	
Material of coolant duct			Stainless steel	
1) For tolerance details refer to chapter 6.4 Tolerances			Latest amendment: 2019-02-08	

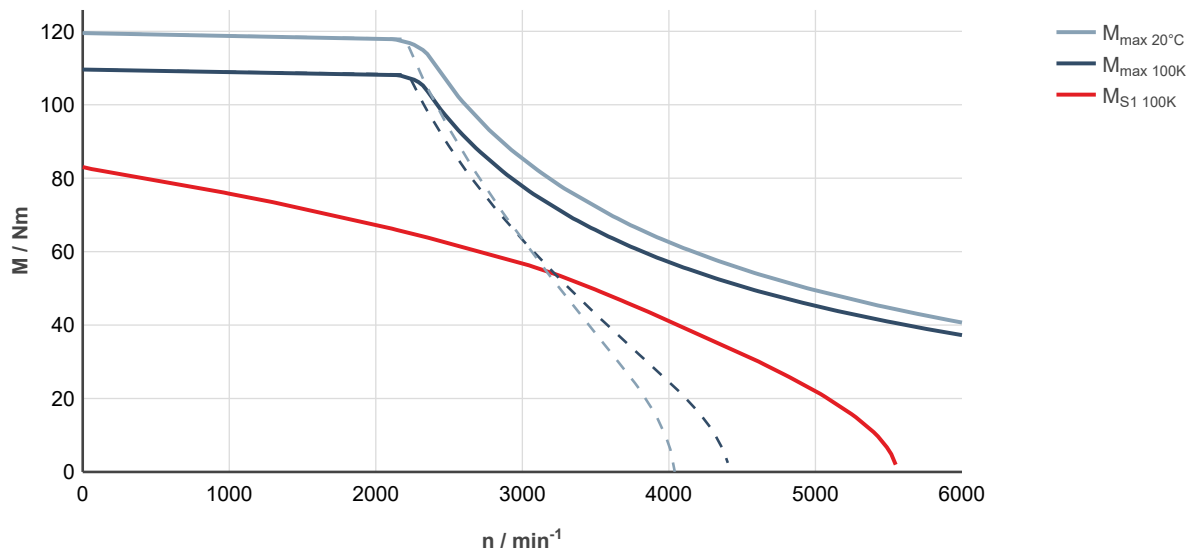

Fig. 181: MS2N07-E0BQL-___0-___-___, ctrIX DRIVE, uncontrolled supply 3 × AC 400 V

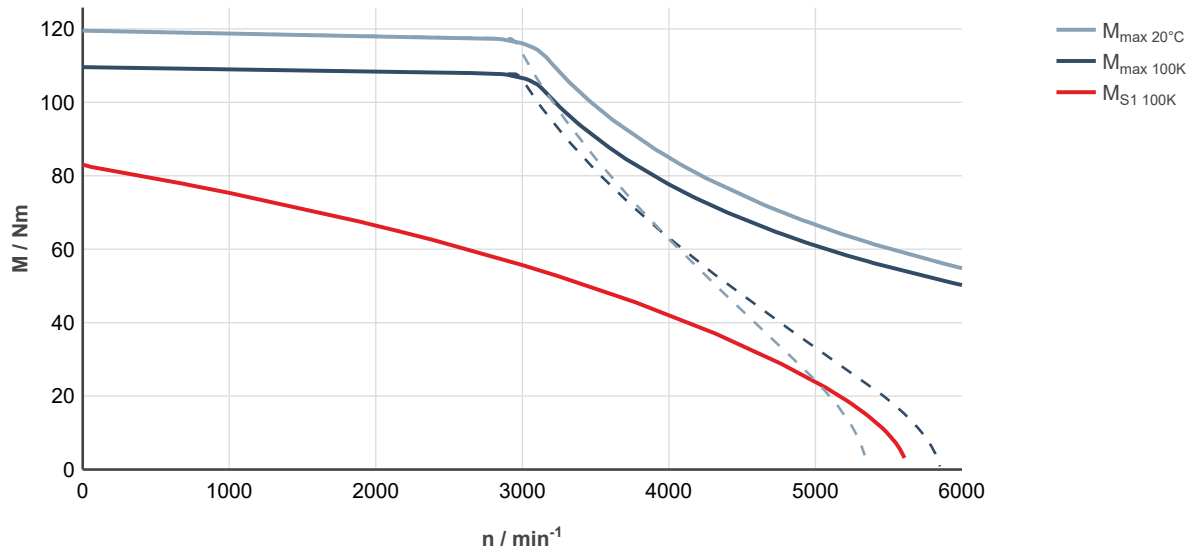

Fig. 182: MS2N07-E0BQL-___0-___-___, ctrIX DRIVE, controlled supply 3 × AC 400 ... 480 V

MS2N07-E1BNL

Designation	Symbol	Unit	MS2N07-E1BNL-__0-N	MS2N07-E1BNL-__2-N
Standstill torque - 100K ¹⁾	$M_{0\ 100K}$	Nm	76.5	
Standstill current - 100K	$I_{0\ 100K}$	A	42.1	
Moment of inertia of rotor ¹⁾	J_{rot}	kg*m ²	0.00752	0.00793
Rated speed - 100K	$n_{N\ 100K}$	1/min	2700	
Rated torque - 100K ¹⁾	$M_{N\ 100K}$	Nm	55.6	
Rated current - 100K	$I_{N\ 100K}$	A	31.6	
Rated power - 100K ¹⁾	$P_{N\ 100K}$	kW	15.7	
Maximum torque 20 °C (cold) ¹⁾	$M_{max\ 20°C}$	Nm	140	
Maximum torque 100K (warm) ¹⁾	$M_{max\ 100K}$	Nm	128.5	
Maximum current	$I_{max(rms)}$	A	85.4	
Maximum speed (electrical)	$n_{max\ el}$	1/min	6000	
Maximum speed (mechanical)	$n_{max\ mech}$	1/min	6000	
Number of pole pairs	p		5	
Torque constant at 20 °C ¹⁾	K_m	Nm/A	1.96	
Voltage constant at 20 °C ¹⁾	K_E	V/1000 min ⁻¹	119.0	
Winding resistance at 20 °C	R_{12}	Ohm	0.532	
Winding inductance	L_{12_min}	mH	5.12	
Leakage capacitance of the component	C_{ab}	nF	4.65	
Thermal time constant of winding	T_{th_W}	s	43.0	
Thermal time constant of motor	T_{th_M}	min	4.4	
Mass	m_{mot}	kg	26.5	29.5
Holding brake				
Holding torque	M_4	Nm	0	36.00
Rated voltage	U_N	V	0	24
Rated current	I_N	A	0	0.94
Maximum connection time	t_1	ms	0	60
Maximum disconnection time	t_2	ms	0	200
Water cooling				
Power loss	P_V	kW	2.0	
Coolant inlet temperature	T_{in}	°C	10 ... 40	
Permissible coolant temperature increase for P_V	ΔT_{max}	K	8.0	
Required coolant flow for P_V	Q_{min}	l/min	3.59	
Pressure drop at Q_{min}	Δp	bar	0.30	
Maximum permissible inlet pressure	p_{max}	bar	6.0	
Volume of coolant duct	V_{cool}	l	0.25	
Material of coolant duct			Stainless steel	
1) For tolerance details refer to chapter 6.4 Tolerances			Latest amendment: 2019-02-08	

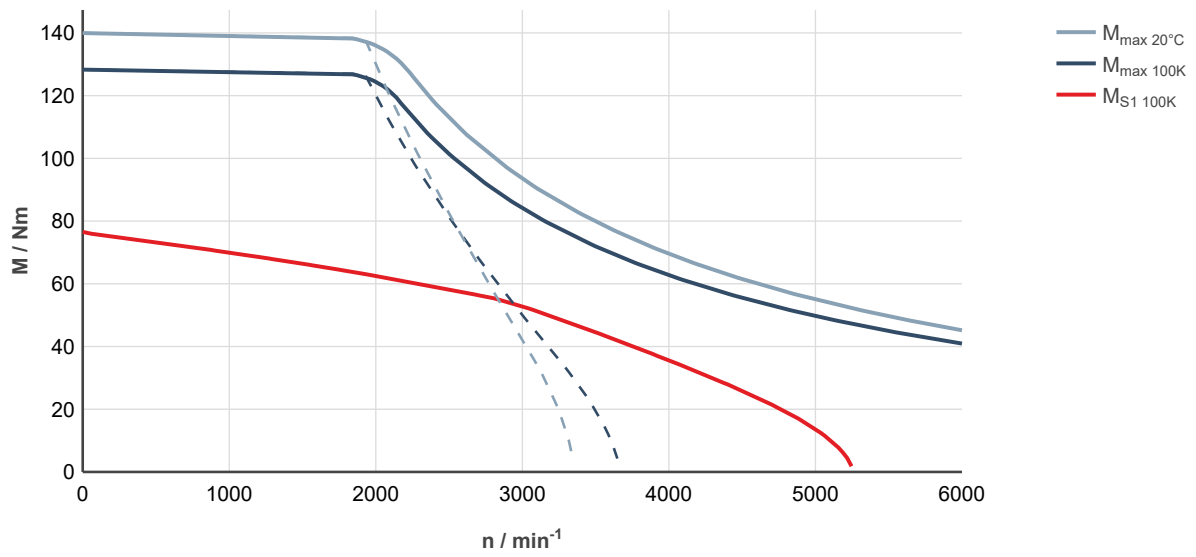

Fig. 183: MS2N07-E1BNL-__0-__-__, ctrlX DRIVE, uncontrolled supply 3 × AC 400 V

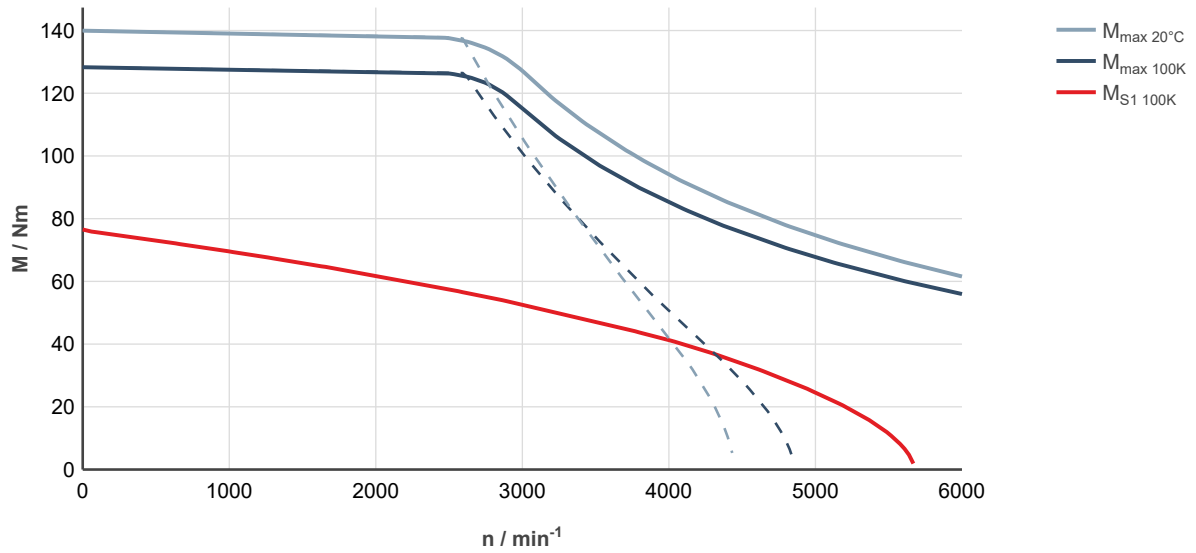
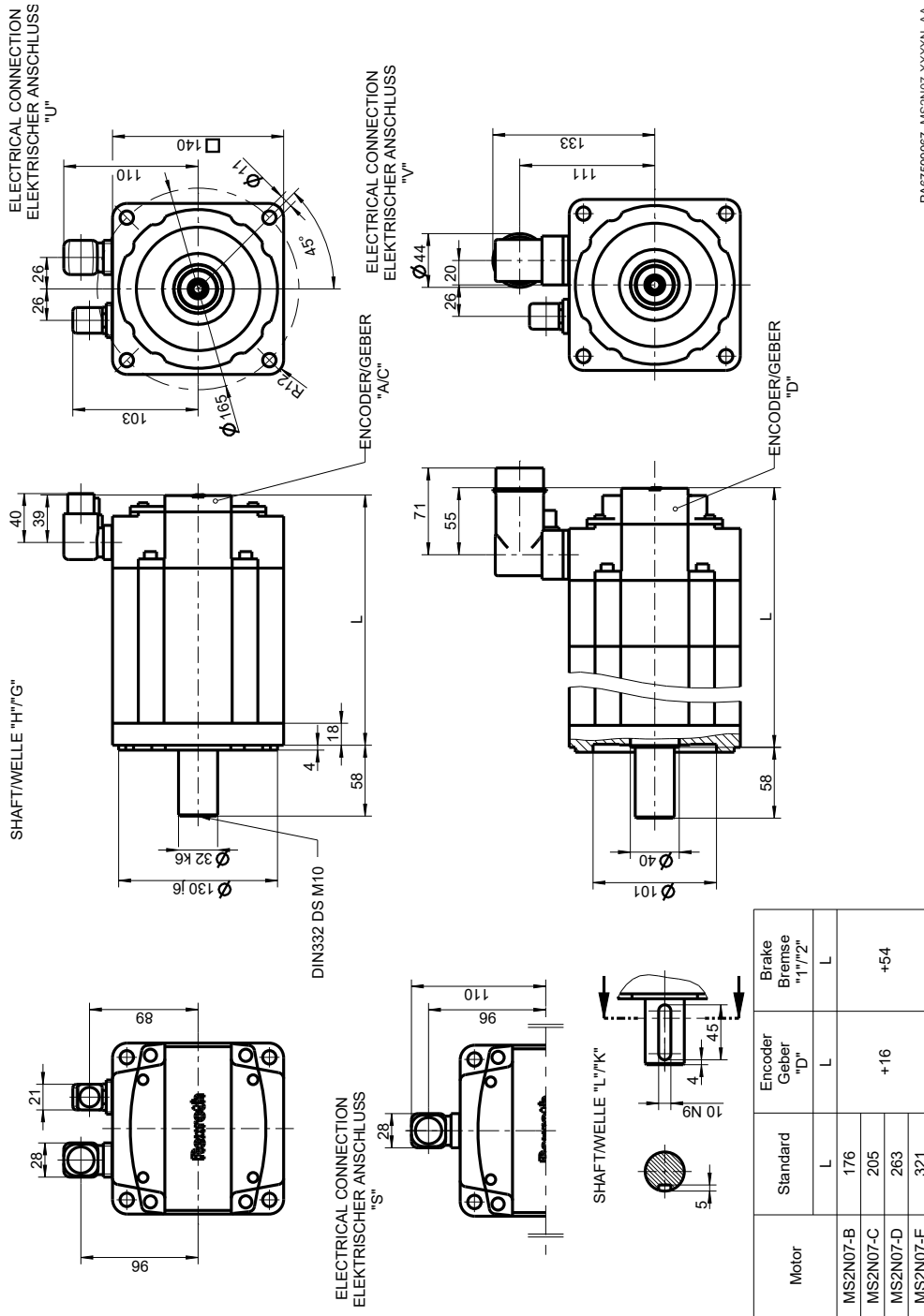

Fig. 184: MS2N07-E1BNL-__0-__-__, ctrlX DRIVE, controlled supply 3 × AC 400 ... 480 V

7.5.4 Self-cooling specification



RA07599967_MS2N07-XXXXN_AA

Fig. 185: MS2N07-xxxxN

7.5.5 Forced ventilation specification

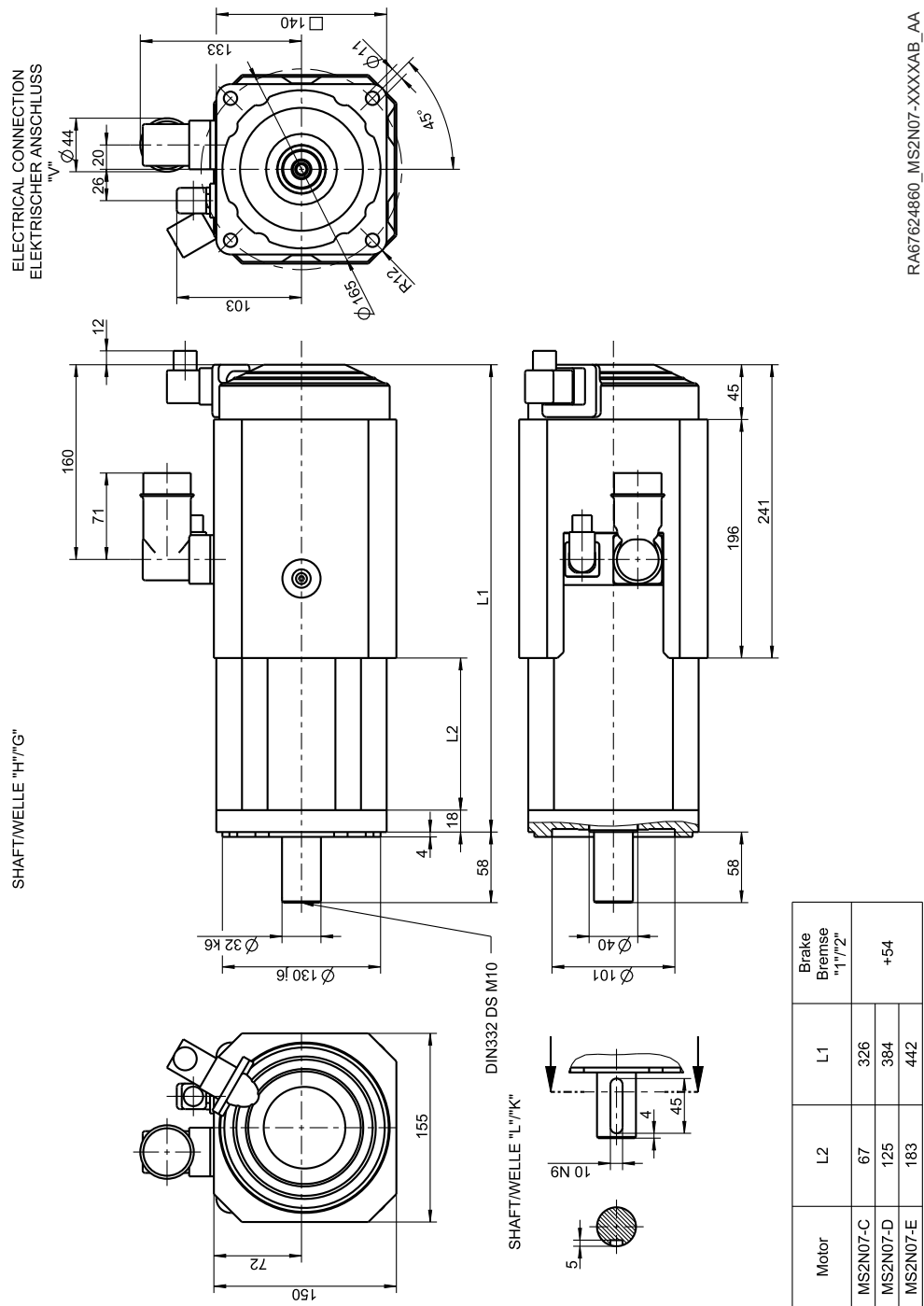
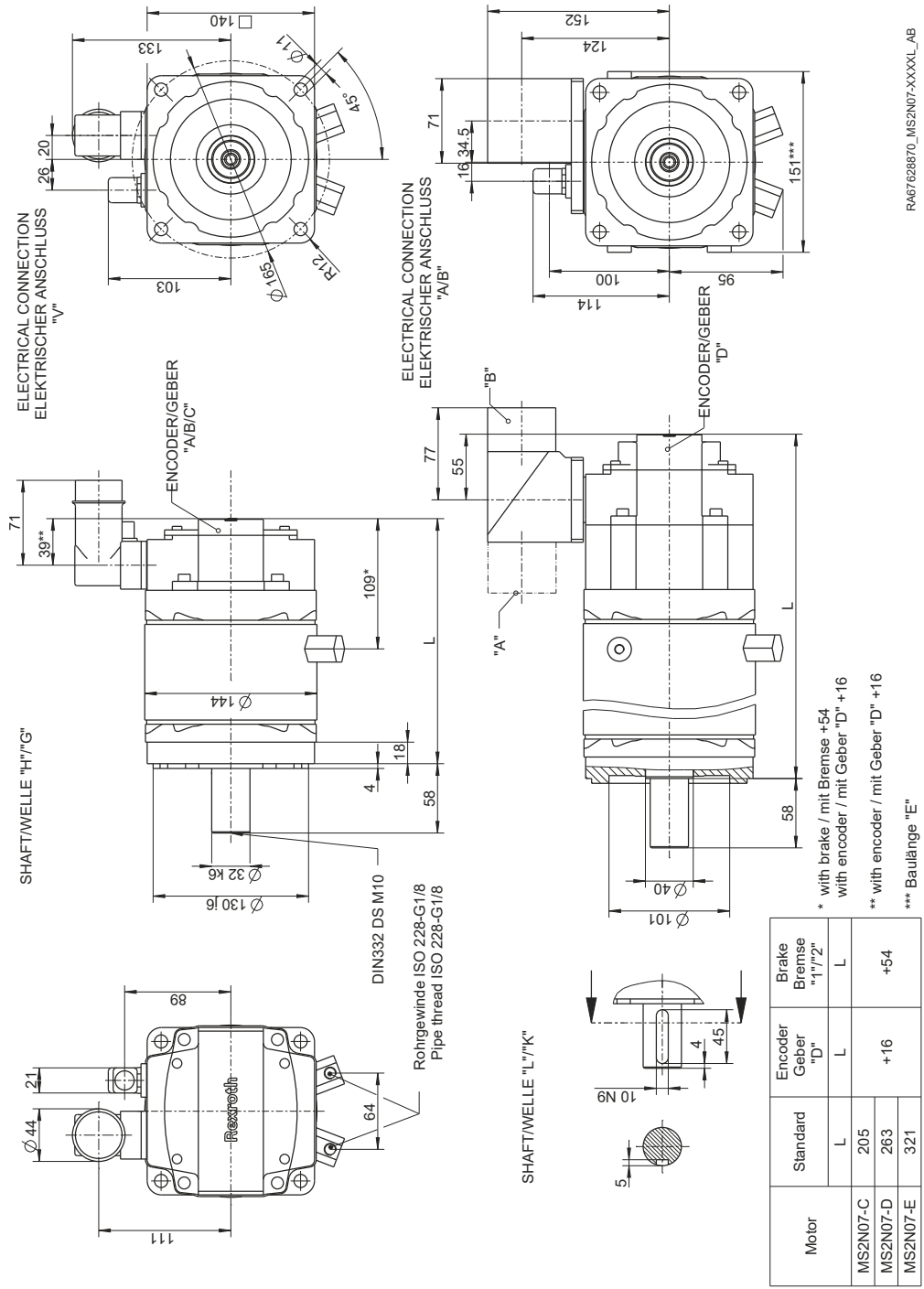

Fig. 186: MS2N07-xxxxA/B

7.5.6 Water cooling specification



RA67628870_MS2N07-XXXXL_AB

Fig. 187: MS2N07\ -XXXXL

7.5.7 MS2N07 Axial force



Axial forces F_A are permissible without limitation up to 60 N. Higher axial forces only after a detailed dimensioning by your distribution partner at Bosch Rexroth. For evaluation purposes, please specify the following information:

- Axial and radial force with force application point
- Installation position (horizontal, vertical with the shaft end pointing to the top or bottom)
- Mean speed

7.5.8 MS2N07 Radial force

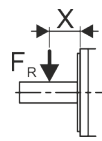

The permissible radial force F_R is specified in distance x from the shaft shoulder, depending on the mean speed in the following diagram.

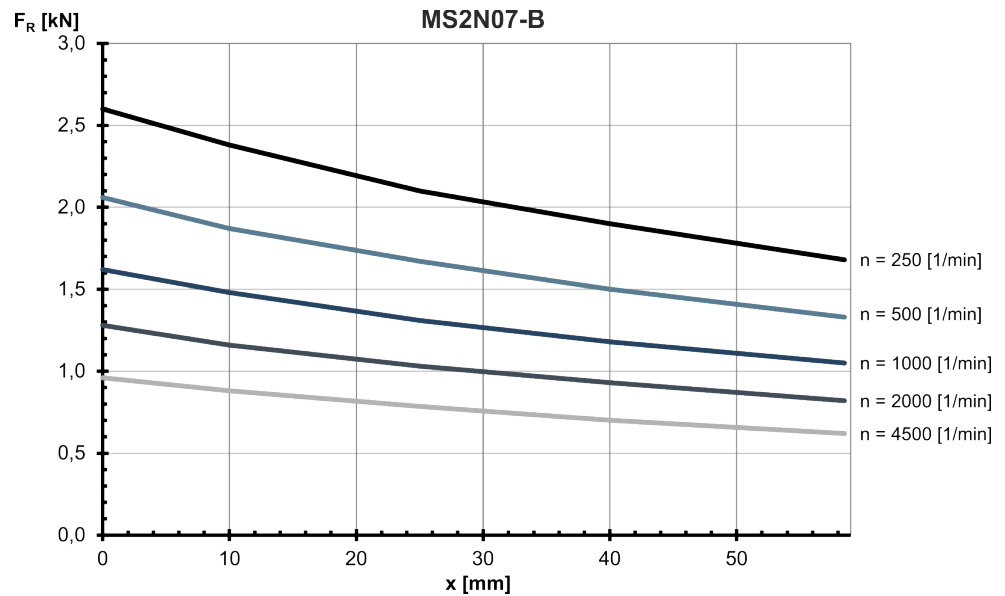

Fig. 188: MS2N07-B: Radial force in distance x from the shaft shoulder at a nominal bearing service life of $L_{h10} = 30000$ h

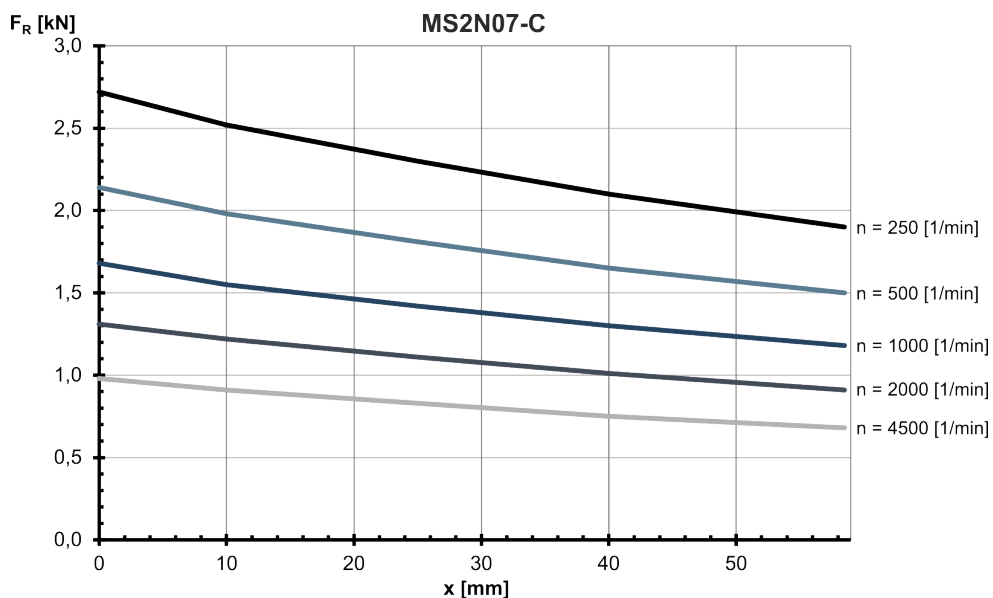

Fig. 189: MS2N07-C: Radial force in distance x from the shaft shoulder at a nominal bearing service life of $L_{h10} = 30000$ h

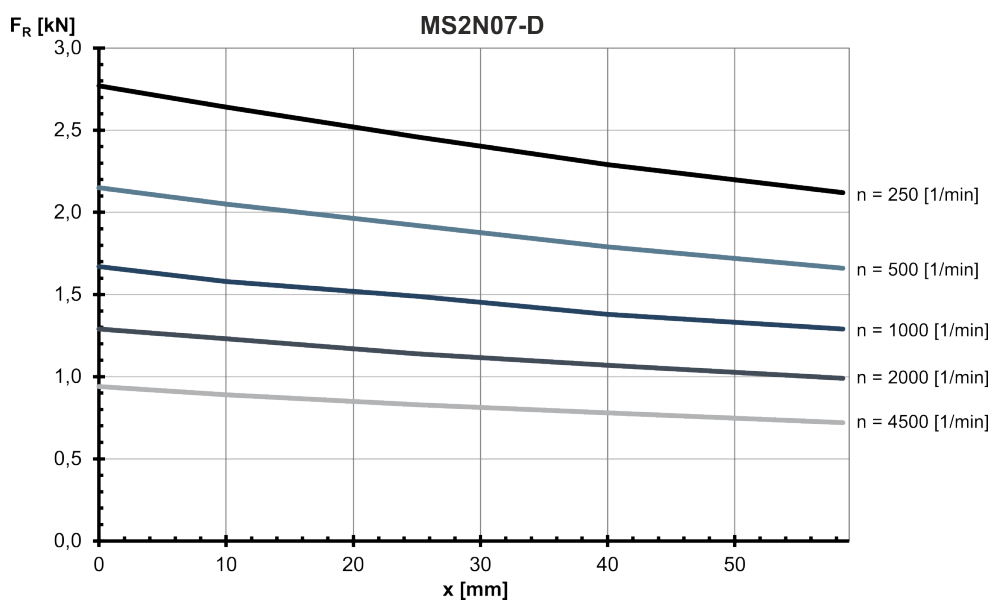

Fig. 190: MS2N07-D: Radial force in distance x from the shaft shoulder at a nominal bearing service life of $L_{h10} = 30000$ h

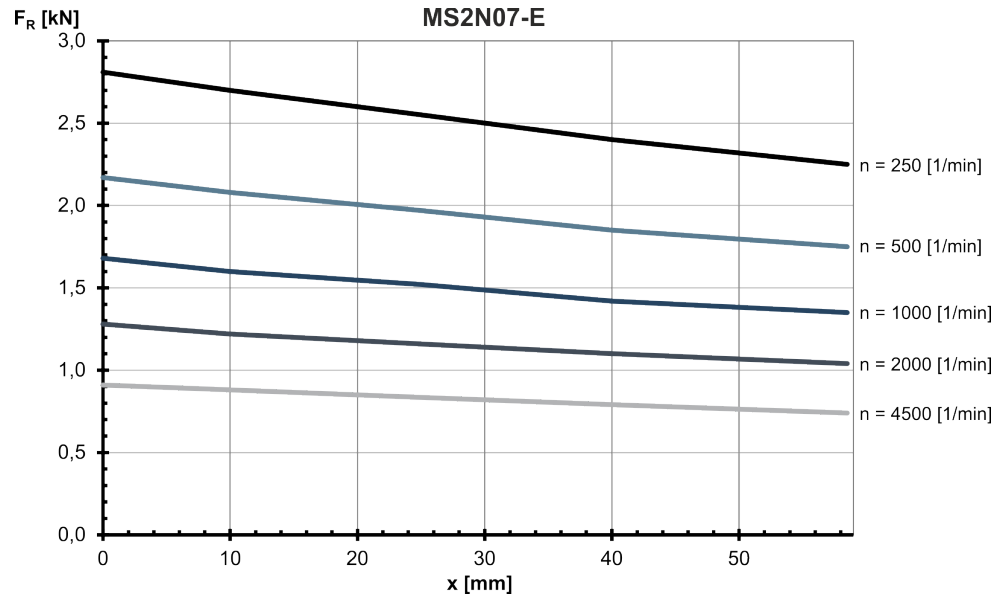

Fig. 191: MS2N07-E: Radial force in distance x from the shaft shoulder at a nominal bearing service life of $L_{h10} = 30000$ h

7.6 MS2N10 Technical data

7.6.1 Self-cooling

MS2N10-B1BQN

Designation	Symbol	Unit	MS2N10-B1BQN-__0-_N	MS2N10-B1BQN-__1-_N
Standstill torque - 60K ¹⁾	M _{0 60K}	Nm	15.6	
Standstill current - 60K	I _{0 60K}	A	13.1	
Standstill torque - 100K ¹⁾	M _{0 100K}	Nm	16.7	
Standstill current - 100K	I _{0 100K}	A	14.2	
Moment of inertia of rotor ¹⁾	J _{rot}	kg*m ²	0.00520	0.00561
Rated speed - 100K	n _{N 100K}	1/min	3520	
Rated torque - 100K ¹⁾	M _{N 100K}	Nm	8.3	
Rated current - 100K	I _{N 100K}	A	7.35	
Rated power - 100K ¹⁾	P _{N 100K}	kW	3.06	
Maximum torque 20 °C (cold) ¹⁾	M _{max 20°C}	Nm	41.3	
Maximum torque 100K (warm) ¹⁾	M _{max 100K}	Nm	38	
Maximum current	I _{max(rms)}	A	42	
Maximum speed (electrical)	n _{max el}	1/min	6000	
Maximum speed (mechanical)	n _{max mech}	1/min	6000	
Number of pole pairs	p		5	
Torque constant at 20 °C ¹⁾	K _m	Nm/A	1.31	
Voltage constant at 20 °C ¹⁾	K _E	V/1000 min ⁻¹	79.6	
Winding resistance at 20 °C	R ₁₂	Ohm	0.642	
Winding inductance	L _{12,min}	mH	7.9	
Leakage capacitance of the component	C _{ab}	nF	1.0	
Thermal time constant of winding	T _{th,W}	s	81.3	
Thermal time constant of motor	T _{th,M}	min	30.6	
Mass	m _{mot}	kg	17.5	21
Holding brake				
Holding torque	M ₄	Nm	0	33.00
Rated voltage	U _N	V	0	24
Rated current	I _N	A	0	0.94
Maximum connection time	t ₁	ms	0	60
Maximum disconnection time	t ₂	ms	0	200

1) For tolerance details refer to [chapter 6.4 Tolerances](#)

Latest amendment: 2019-07-02

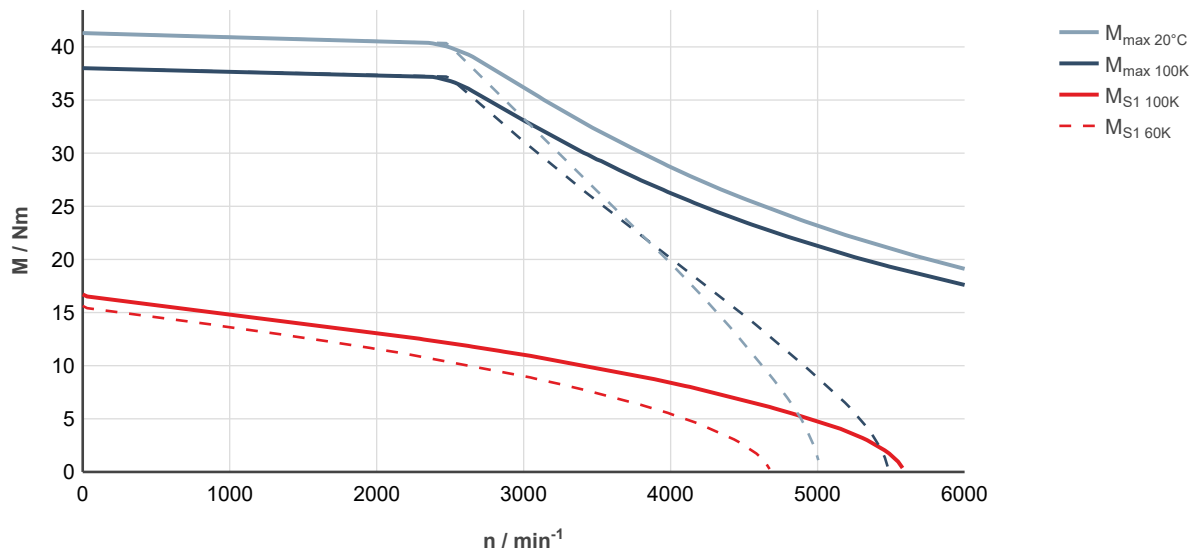

Fig. 192: MS2N10-B1BQN-___0-___-_, ctrlX DRIVE, uncontrolled supply 3 × AC 400 V

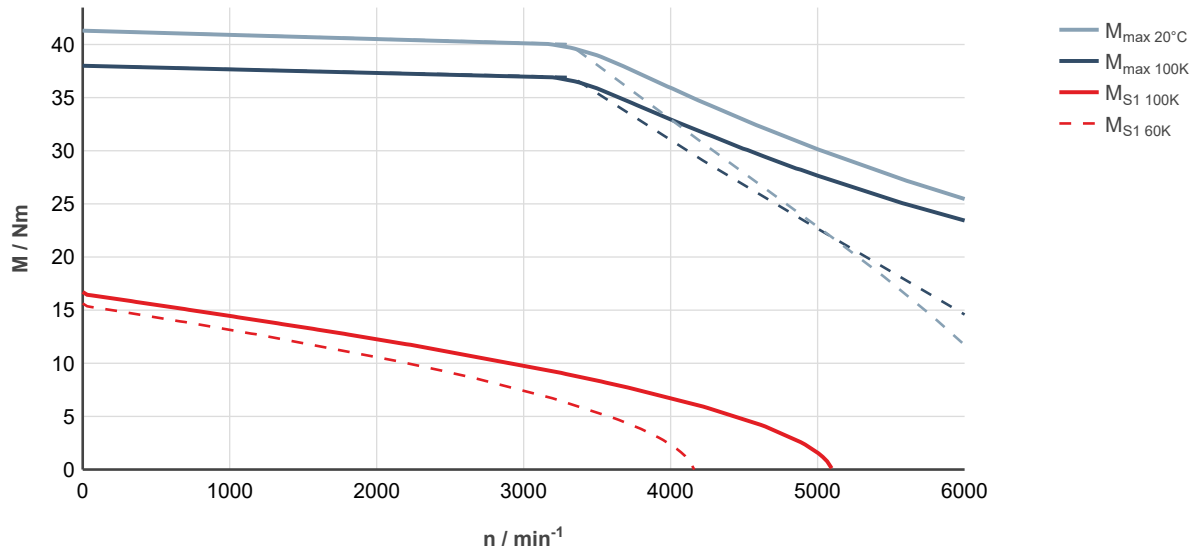

Fig. 193: MS2N10-B1BQN-___0-___-_, ctrlX DRIVE, controlled supply 3 × AC 400 ... 480 V

MS2N10-C0BHN

Designation	Symbol	Unit	MS2N10-C0BHN-__0-_N	MS2N10-C0BHN-__2-_N
Standstill torque - 60K ¹⁾	M _{0 60K}	Nm	30.2	
Standstill current - 60K	I _{0 60K}	A	12.6	
Standstill torque - 100K ¹⁾	M _{0 100K}	Nm	34.0	
Standstill current - 100K	I _{0 100K}	A	14.5	
Moment of inertia of rotor ¹⁾	J _{rot}	kg*m ²	0.0048	0.00627
Rated speed - 100K	n _{N 100K}	1/min	2000	
Rated torque - 100K ¹⁾	M _{N 100K}	Nm	27.2	
Rated current - 100K	I _{N 100K}	A	11.7	
Rated power - 100K ¹⁾	P _{N 100K}	kW	5.7	
Maximum torque 20 °C (cold) ¹⁾	M _{max 20°C}	Nm	76.8	
Maximum torque 100K (warm) ¹⁾	M _{max 100K}	Nm	70.5	
Maximum current	I _{max(rms)}	A	38.5	
Maximum speed (electrical)	n _{max el}	1/min	4000	
Maximum speed (mechanical)	n _{max mech}	1/min	6000	
Number of pole pairs	p		5	
Torque constant at 20 °C ¹⁾	K _m	Nm/A	2.60	
Voltage constant at 20 °C ¹⁾	K _E	V/1000 min ⁻¹	157.8	
Winding resistance at 20 °C	R ₁₂	Ohm	0.74	
Winding inductance	L _{12,min}	mH	18.7	
Leakage capacitance of the component	C _{ab}	nF	1.9	
Thermal time constant of winding	T _{th,W}	s	99.3	
Thermal time constant of motor	T _{th,M}	min	33.0	
Mass	m _{mot}	kg	23.5	28.5
Holding brake				
Holding torque	M ₄	Nm	0	53.00
Rated voltage	U _N	V	0	24
Rated current	I _N	A	0	1.00
Maximum connection time	t ₁	ms	0	70
Maximum disconnection time	t ₂	ms	0	220

1) For tolerance details refer to [chapter 6.4 Tolerances](#) Latest amendment: 2019-07-02

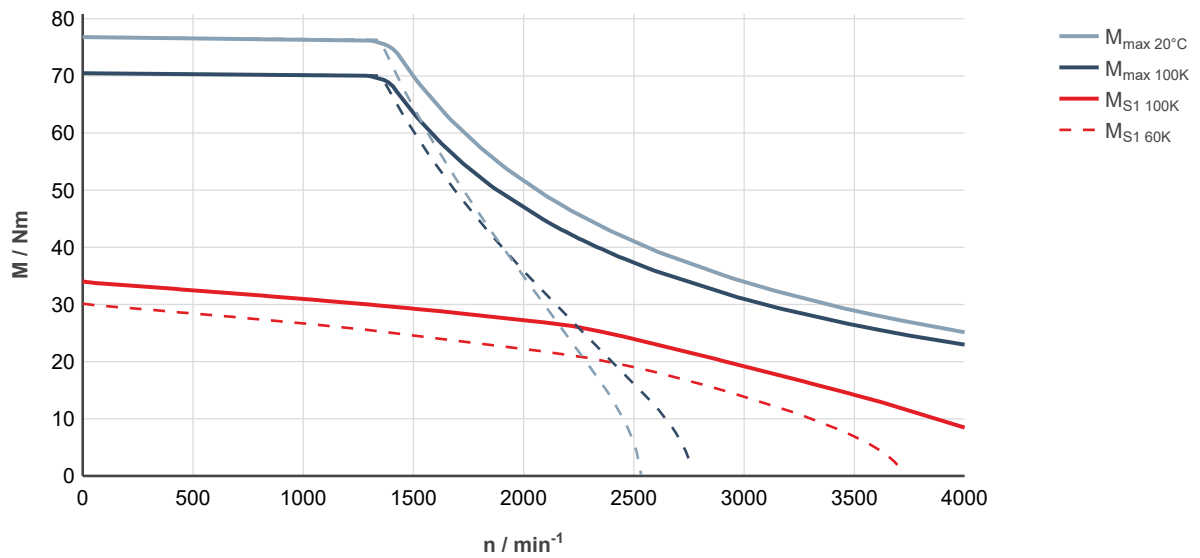

Fig. 194: MS2N10-C0BHN-___0-___-_, ctrlX DRIVE, uncontrolled supply 3 × AC 400 V

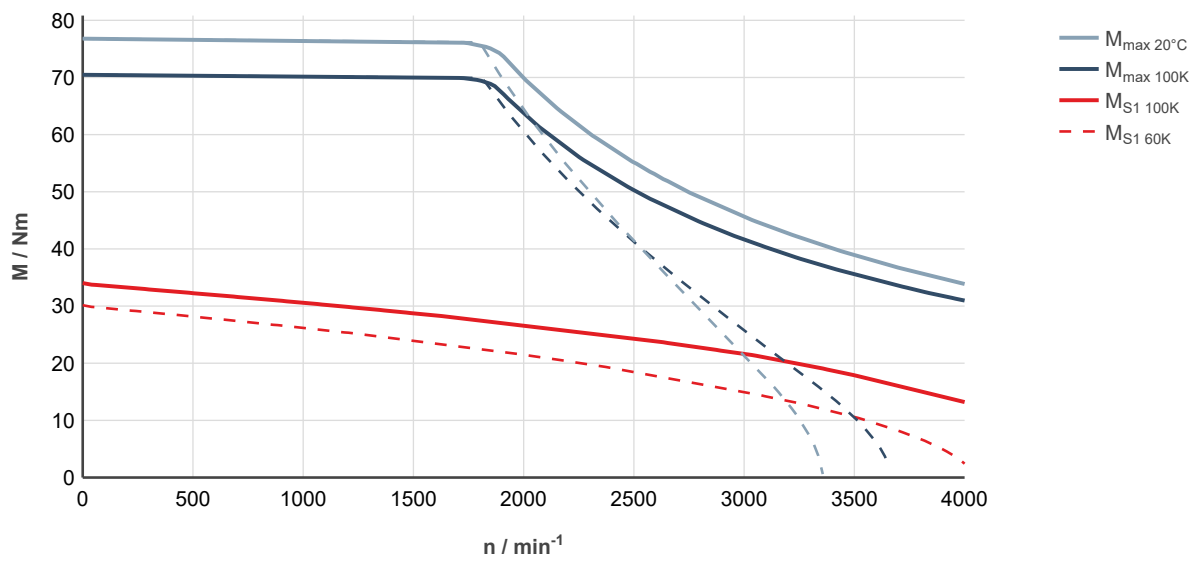

Fig. 195: MS2N10-C0BHN-___0-___-_, ctrlX DRIVE, controlled supply 3 × AC 400 ... 480 V

MS2N10-C0BNN

Designation	Symbol	Unit	MS2N10-C0BNN-__0-_N	MS2N10-C0BNN-__2-_N
Standstill torque - 60K ¹⁾	M _{0 60K}	Nm	30.2	
Standstill current - 60K	I _{0 60K}	A	16.8	
Standstill torque - 100K ¹⁾	M _{0 100K}	Nm	34.0	
Standstill current - 100K	I _{0 100K}	A	19.3	
Moment of inertia of rotor ¹⁾	J _{rot}	kg*m ²	0.0048	0.00627
Rated speed - 100K	n _{N 100K}	1/min	2880	
Rated torque - 100K ¹⁾	M _{N 100K}	Nm	21.4	
Rated current - 100K	I _{N 100K}	A	12.35	
Rated power - 100K ¹⁾	P _{N 100K}	kW	6.45	
Maximum torque 20 °C (cold) ¹⁾	M _{max 20°C}	Nm	76.8	
Maximum torque 100K (warm) ¹⁾	M _{max 100K}	Nm	70.5	
Maximum current	I _{max(rms)}	A	51.3	
Maximum speed (electrical)	n _{max el}	1/min	6000	
Maximum speed (mechanical)	n _{max mech}	1/min	6000	
Number of pole pairs	p		5	
Torque constant at 20 °C ¹⁾	K _m	Nm/A	1.95	
Voltage constant at 20 °C ¹⁾	K _E	V/1000 min ⁻¹	118.4	
Winding resistance at 20 °C	R ₁₂	Ohm	0.441	
Winding inductance	L _{12_min}	mH	10.67	
Leakage capacitance of the component	C _{ab}	nF	1.97	
Thermal time constant of winding	T _{th_W}	s	99.3	
Thermal time constant of motor	T _{th_M}	min	33.0	
Mass	m _{mot}	kg	23.5	28.5
Holding brake				
Holding torque	M ₄	Nm	0	53.00
Rated voltage	U _N	V	0	24
Rated current	I _N	A	0	1.00
Maximum connection time	t ₁	ms	0	70
Maximum disconnection time	t ₂	ms	0	220
1) For tolerance details refer to chapter 6.4 Tolerances			Latest amendment: 2019-07-02	

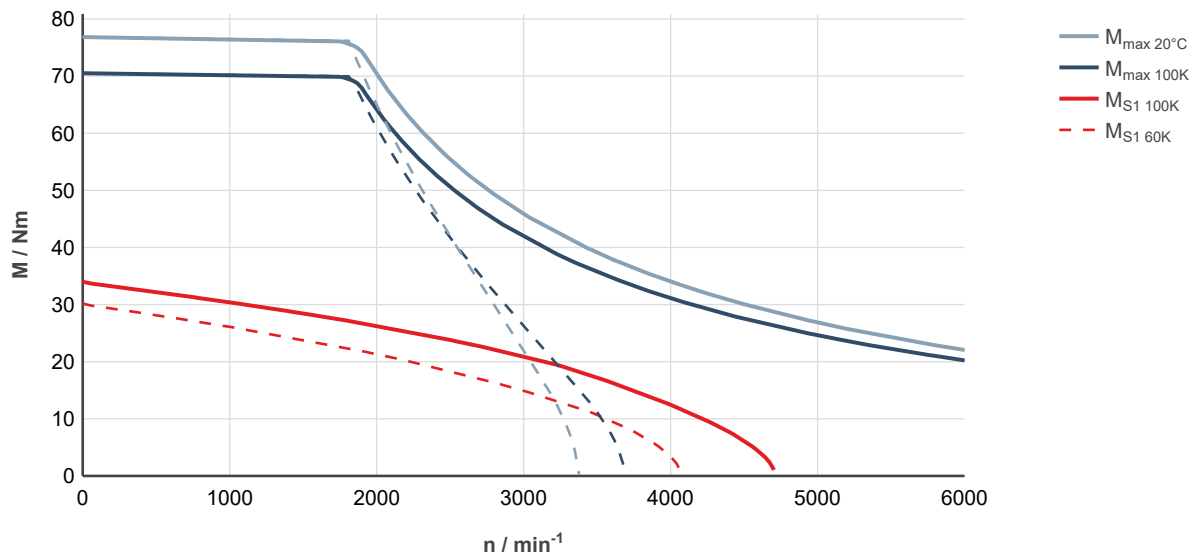

Fig. 196: MS2N10-C0BNN-___0-___- , ctrlX DRIVE, uncontrolled supply 3 × AC 400 V

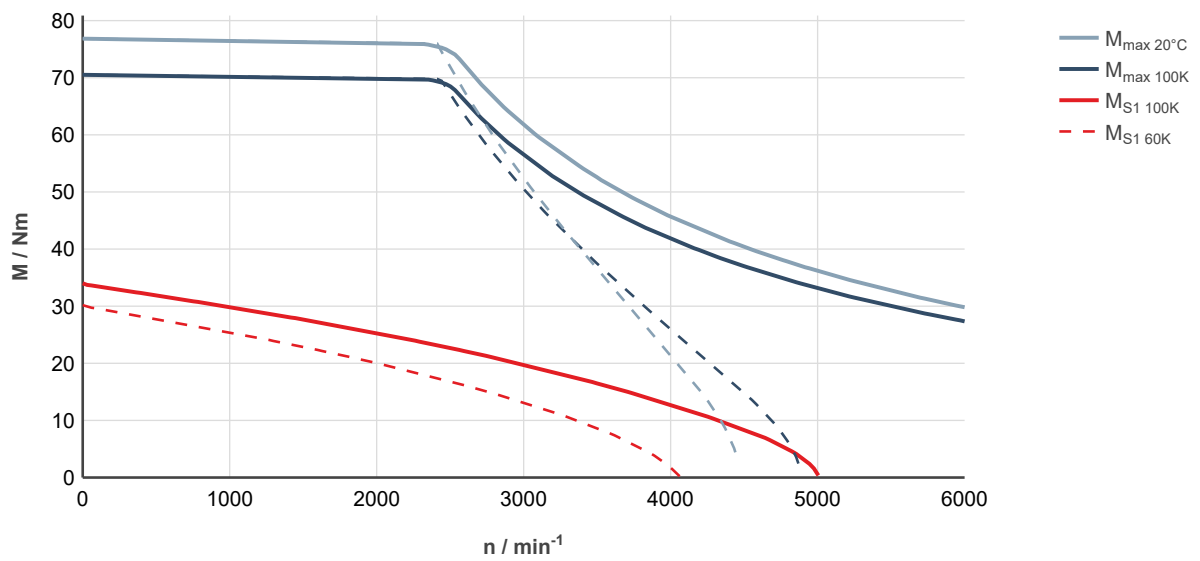

Fig. 197: MS2N10-C0BNN-___0-___- , ctrlX DRIVE, controlled supply 3 × AC 400 ... 480 V

MS2N10-C1BHN

Designation	Symbol	Unit	MS2N10-C1BHN-__0-_N	MS2N10-C1BHN-__2-_N
Standstill torque - 60K ¹⁾	M _{0 60K}	Nm	27.3	
Standstill current - 60K	I _{0 60K}	A	11.1	
Standstill torque - 100K ¹⁾	M _{0 100K}	Nm	31.0	
Standstill current - 100K	I _{0 100K}	A	12.75	
Moment of inertia of rotor ¹⁾	J _{rot}	kg*m ²	0.0092	0.01067
Rated speed - 100K	n _{N 100K}	1/min	2000	
Rated torque - 100K ¹⁾	M _{N 100K}	Nm	22.9	
Rated current - 100K	I _{N 100K}	A	9.7	
Rated power - 100K ¹⁾	P _{N 100K}	kW	4.80	
Maximum torque 20 °C (cold) ¹⁾	M _{max 20°C}	Nm	86.5	
Maximum torque 100K (warm) ¹⁾	M _{max 100K}	Nm	79.4	
Maximum current	I _{max(rms)}	A	40.9	
Maximum speed (electrical)	n _{max el}	1/min	4000	
Maximum speed (mechanical)	n _{max mech}	1/min	6000	
Number of pole pairs	p		5	
Torque constant at 20 °C ¹⁾	K _m	Nm/A	2.63	
Voltage constant at 20 °C ¹⁾	K _E	V/1000 min ⁻¹	160	
Winding resistance at 20 °C	R ₁₂	Ohm	0.96	
Winding inductance	L _{12,min}	mH	15.29	
Leakage capacitance of the component	C _{ab}	nF	1.8	
Thermal time constant of winding	T _{th,W}	s	85.0	
Thermal time constant of motor	T _{th,M}	min	33.0	
Mass	m _{mot}	kg	24	29
Holding brake				
Holding torque	M ₄	Nm	0	53.00
Rated voltage	U _N	V	0	24
Rated current	I _N	A	0	1.00
Maximum connection time	t ₁	ms	0	70
Maximum disconnection time	t ₂	ms	0	220
1) For tolerance details refer to chapter 6.4 Tolerances			Latest amendment: 2019-07-02	

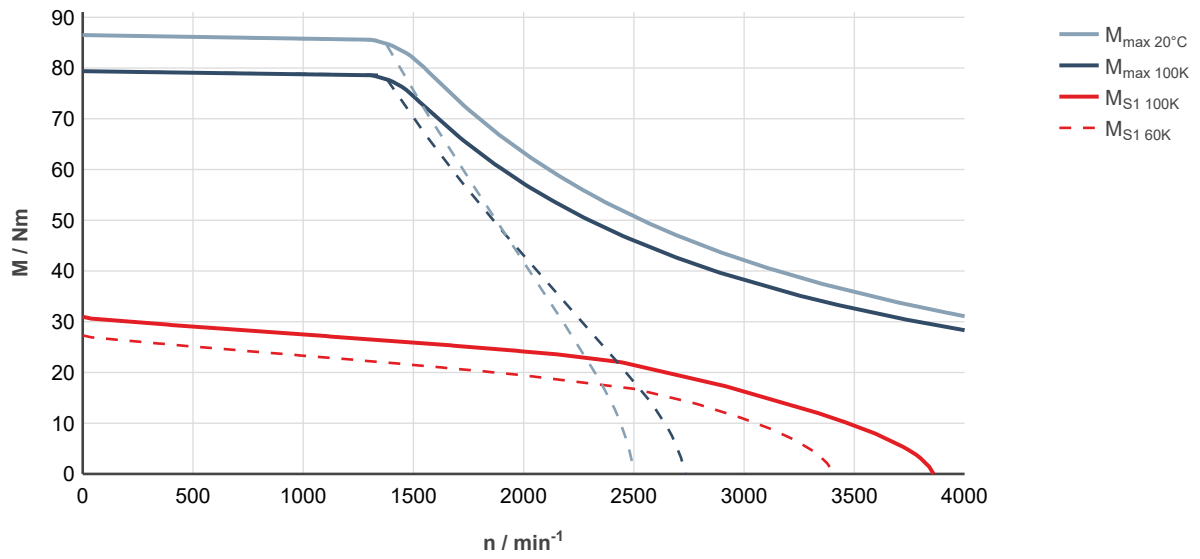

Fig. 198: MS2N10-C1BHN-___0-___-_, ctrlX DRIVE, uncontrolled supply 3 × AC 400 V

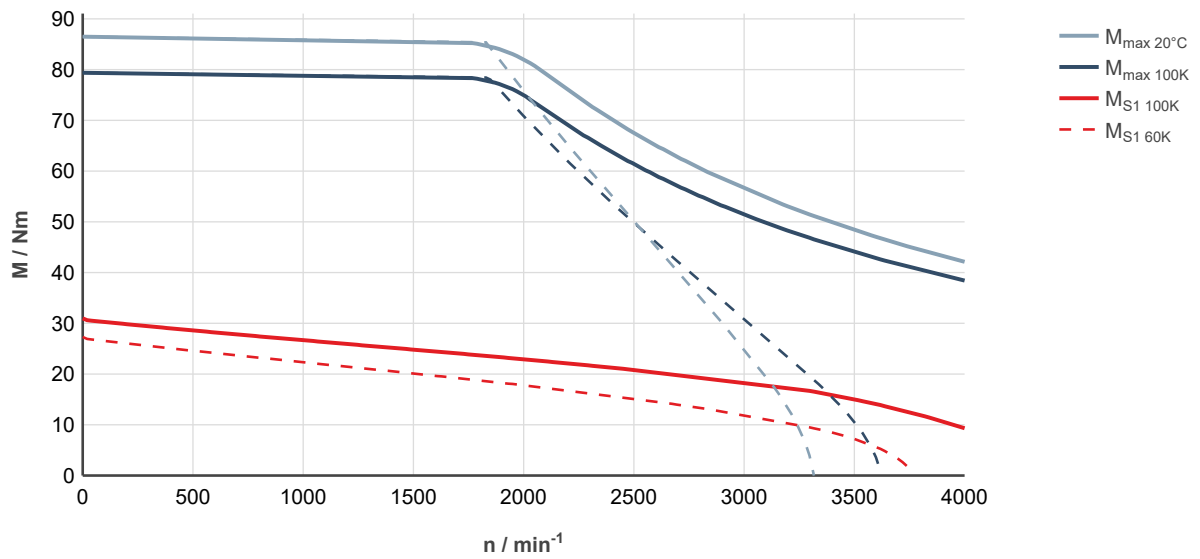

Fig. 199: MS2N10-C1BHN-___0-___-_, ctrlX DRIVE, controlled supply 3 × AC 400 ... 480 V

MS2N10-C1BNN

Designation	Symbol	Unit	MS2N10-C1BNN-__0-_N	MS2N10-C1BNN-__2-_N
Standstill torque - 60K ¹⁾	M _{0 60K}	Nm	27.3	
Standstill current - 60K	I _{0 60K}	A	16.5	
Standstill torque - 100K ¹⁾	M _{0 100K}	Nm	31.0	
Standstill current - 100K	I _{0 100K}	A	19	
Moment of inertia of rotor ¹⁾	J _{rot}	kg*m ²	0.0092	0.01067
Rated speed - 100K	n _{N 100K}	1/min	3090	
Rated torque - 100K ¹⁾	M _{N 100K}	Nm	13.75	
Rated current - 100K	I _{N 100K}	A	8.90	
Rated power - 100K ¹⁾	P _{N 100K}	kW	4.44	
Maximum torque 20 °C (cold) ¹⁾	M _{max 20°C}	Nm	86.5	
Maximum torque 100K (warm) ¹⁾	M _{max 100K}	Nm	79.4	
Maximum current	I _{max(rms)}	A	60.8	
Maximum speed (electrical)	n _{max el}	1/min	6000	
Maximum speed (mechanical)	n _{max mech}	1/min	6000	
Number of pole pairs	p		5	
Torque constant at 20 °C ¹⁾	K _m	Nm/A	1.78	
Voltage constant at 20 °C ¹⁾	K _E	V/1000 min ⁻¹	107.9	
Winding resistance at 20 °C	R ₁₂	Ohm	0.439	
Winding inductance	L _{12,min}	mH	6.6	
Leakage capacitance of the component	C _{ab}	nF	1.52	
Thermal time constant of winding	T _{th,W}	s	85.0	
Thermal time constant of motor	T _{th,M}	min	33.0	
Mass	m _{mot}	kg	24	29
Holding brake				
Holding torque	M ₄	Nm	0	53.00
Rated voltage	U _N	V	0	24
Rated current	I _N	A	0	1.00
Maximum connection time	t ₁	ms	0	70
Maximum disconnection time	t ₂	ms	0	220

1) For tolerance details refer to [chapter 6.4 Tolerances](#)

Latest amendment: 2019-07-02

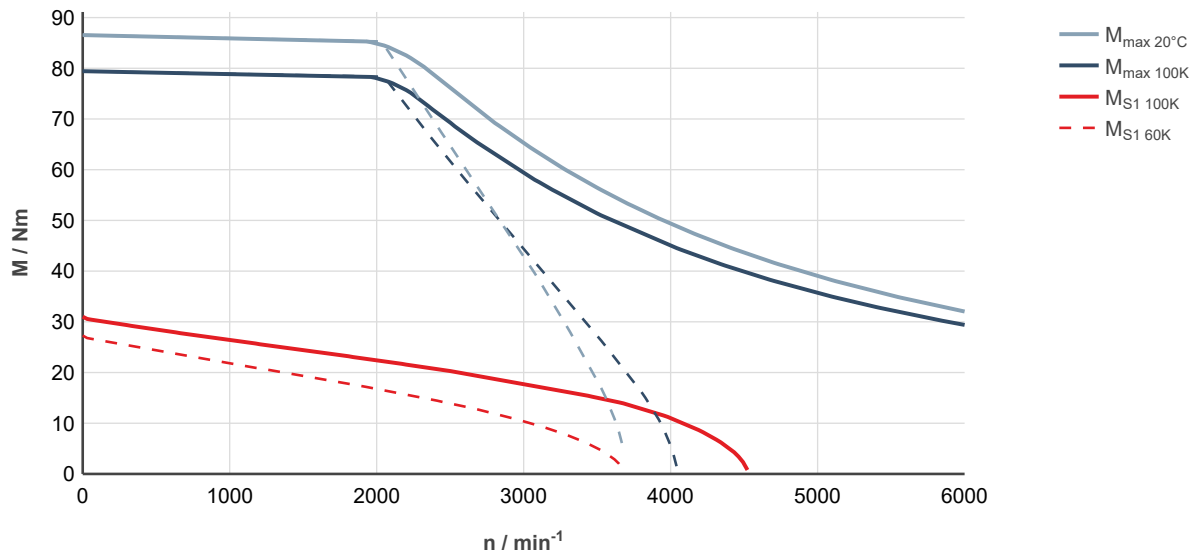

Fig. 200: MS2N10-C1BNN-___0-___-_, ctrlX DRIVE, uncontrolled supply 3 × AC 400 V

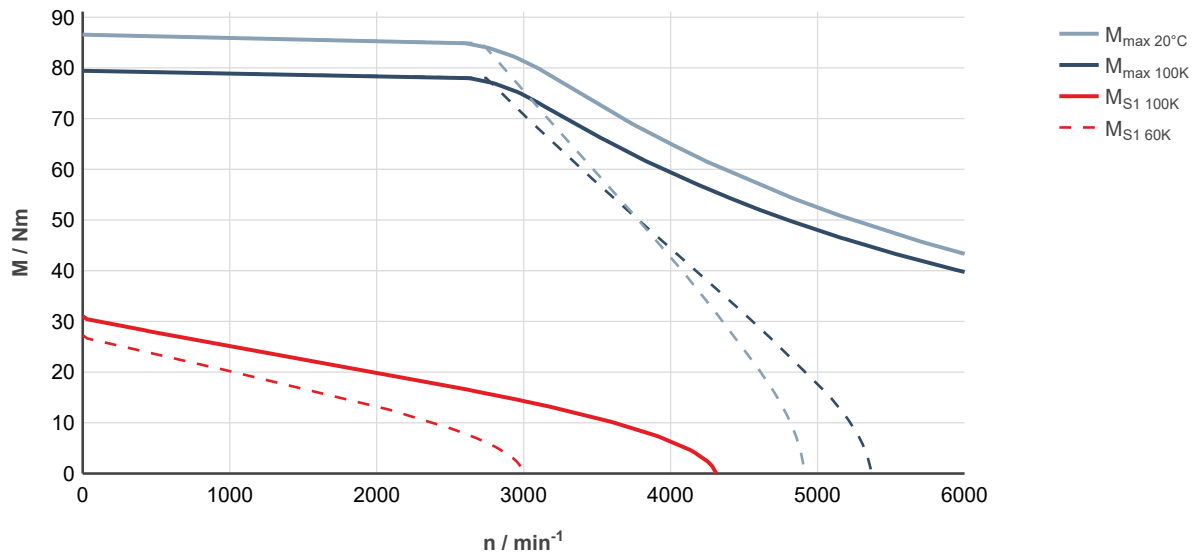

Fig. 201: MS2N10-C1BNN-___0-___-_, ctrlX DRIVE, controlled supply 3 × AC 400 ... 480 V

MS2N10-D0BHN

Designation	Symbol	Unit	MS2N10-D0BHN-__0-_N	MS2N10-D0BHN-__2-_N
Standstill torque - 60K ¹⁾	M _{0 60K}	Nm	51	
Standstill current - 60K	I _{0 60K}	A	19.1	
Standstill torque - 100K ¹⁾	M _{0 100K}	Nm	60.5	
Standstill current - 100K	I _{0 100K}	A	23.1	
Moment of inertia of rotor ¹⁾	J _{rot}	kg*m ²	0.0081	0.00957
Rated speed - 100K	n _{N 100K}	1/min	2000	
Rated torque - 100K ¹⁾	M _{N 100K}	Nm	44.6	
Rated current - 100K	I _{N 100K}	A	17.3	
Rated power - 100K ¹⁾	P _{N 100K}	kW	9.35	
Maximum torque 20 °C (cold) ¹⁾	M _{max 20°C}	Nm	155	
Maximum torque 100K (warm) ¹⁾	M _{max 100K}	Nm	142	
Maximum current	I _{max(rms)}	A	70	
Maximum speed (electrical)	n _{max el}	1/min	4000	
Maximum speed (mechanical)	n _{max mech}	1/min	6000	
Number of pole pairs	p		5	
Torque constant at 20 °C ¹⁾	K _m	Nm/A	2.86	
Voltage constant at 20 °C ¹⁾	K _E	V/1000 min ⁻¹	173.5	
Winding resistance at 20 °C	R ₁₂	Ohm	0.386	
Winding inductance	L _{12,min}	mH	10.3	
Leakage capacitance of the component	C _{ab}	nF	3.15	
Thermal time constant of winding	T _{th,W}	s	113.6	
Thermal time constant of motor	T _{th,M}	min	38.8	
Mass	m _{mot}	kg	34	39
Holding brake				
Holding torque	M ₄	Nm	0	53.00
Rated voltage	U _N	V	0	24
Rated current	I _N	A	0	1.00
Maximum connection time	t ₁	ms	0	70
Maximum disconnection time	t ₂	ms	0	220

1) For tolerance details refer to [chapter 6.4 Tolerances](#)

Latest amendment: 2019-07-02

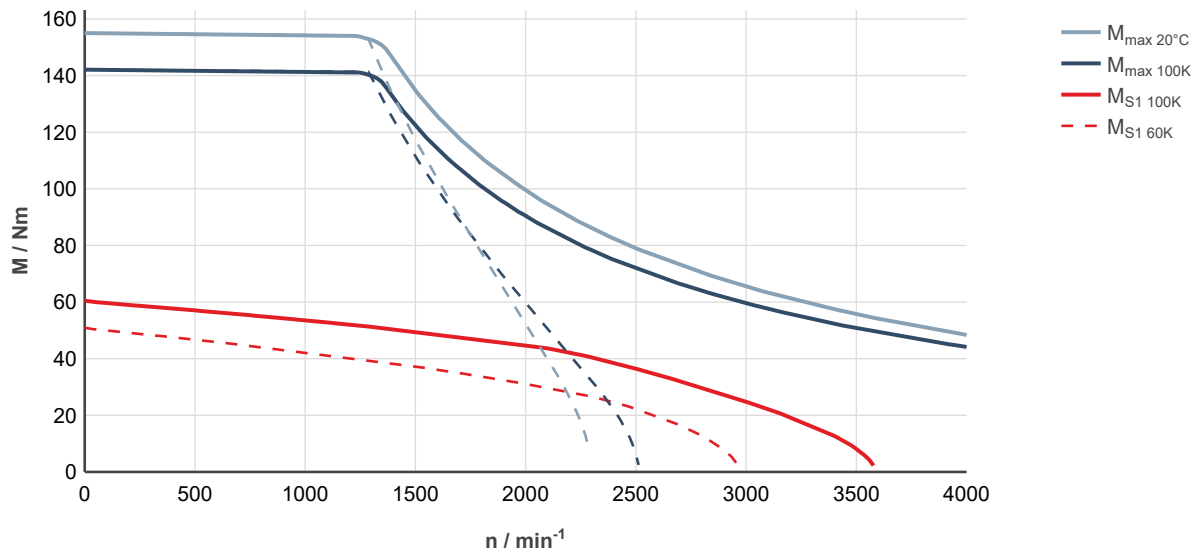

Fig. 202: MS2N10-D0BHN-___0-___-, ctrlX DRIVE, uncontrolled supply 3 × AC 400 V

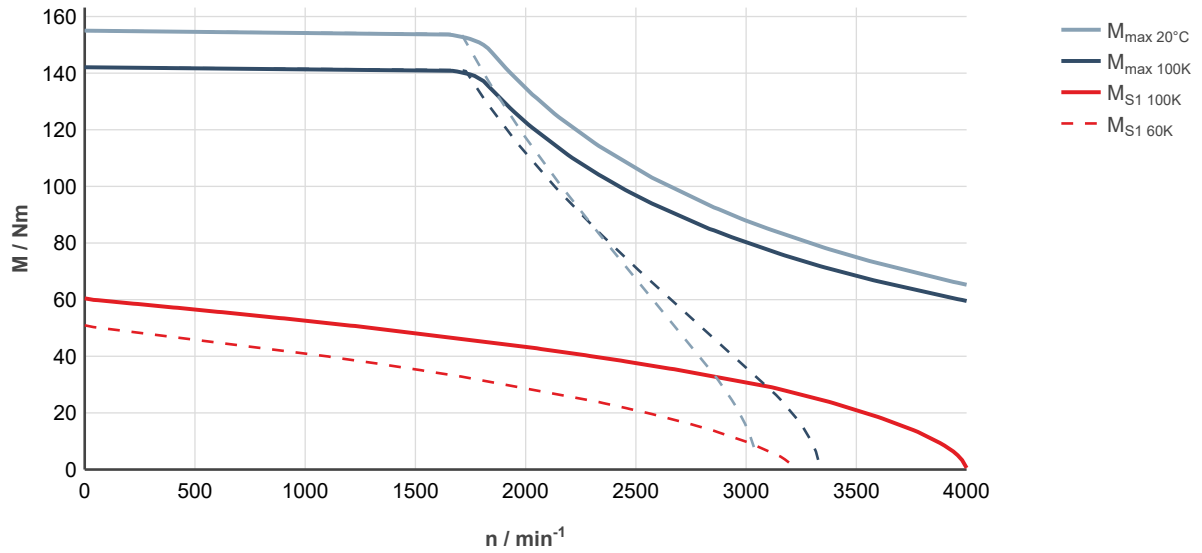

Fig. 203: MS2N10-D0BHN-___0-___-, ctrlX DRIVE, controlled supply 3 × AC 400 ... 480 V

MS2N10-D0BNN

Designation	Symbol	Unit	MS2N10-D0BNN-__0-_N	MS2N10-D0BNN-__2-_N
Standstill torque - 60K ¹⁾	M _{0 60K}	Nm	51.0	
Standstill current - 60K	I _{0 60K}	A	28.2	
Standstill torque - 100K ¹⁾	M _{0 100K}	Nm	60.5	
Standstill current - 100K	I _{0 100K}	A	34.1	
Moment of inertia of rotor ¹⁾	J _{rot}	kg*m ²	0.0081	0.00957
Rated speed - 100K	n _{N 100K}	1/min	2600	
Rated torque - 100K ¹⁾	M _{N 100K}	Nm	31.0	
Rated current - 100K	I _{N 100K}	A	18.0	
Rated power - 100K ¹⁾	P _{N 100K}	kW	8.45	
Maximum torque 20 °C (cold) ¹⁾	M _{max 20°C}	Nm	155	
Maximum torque 100K (warm) ¹⁾	M _{max 100K}	Nm	142	
Maximum current	I _{max(rms)}	A	102.5	
Maximum speed (electrical)	n _{max el}	1/min	6000	
Maximum speed (mechanical)	n _{max mech}	1/min	6000	
Number of pole pairs	p		5	
Torque constant at 20 °C ¹⁾	K _m	Nm/A	1.95	
Voltage constant at 20 °C ¹⁾	K _E	V/1000 min ⁻¹	118.5	
Winding resistance at 20 °C	R ₁₂	Ohm	0.18	
Winding inductance	L _{12,min}	mH	5.05	
Leakage capacitance of the component	C _{ab}	nF	4.1	
Thermal time constant of winding	T _{th,W}	s	113.6	
Thermal time constant of motor	T _{th,M}	min	38.8	
Mass	m _{mot}	kg	34	39
Holding brake				
Holding torque	M ₄	Nm	0	53.00
Rated voltage	U _N	V	0	24
Rated current	I _N	A	0	1.00
Maximum connection time	t ₁	ms	0	70
Maximum disconnection time	t ₂	ms	0	220

1) For tolerance details refer to [chapter 6.4 Tolerances](#) Latest amendment: 2019-07-02

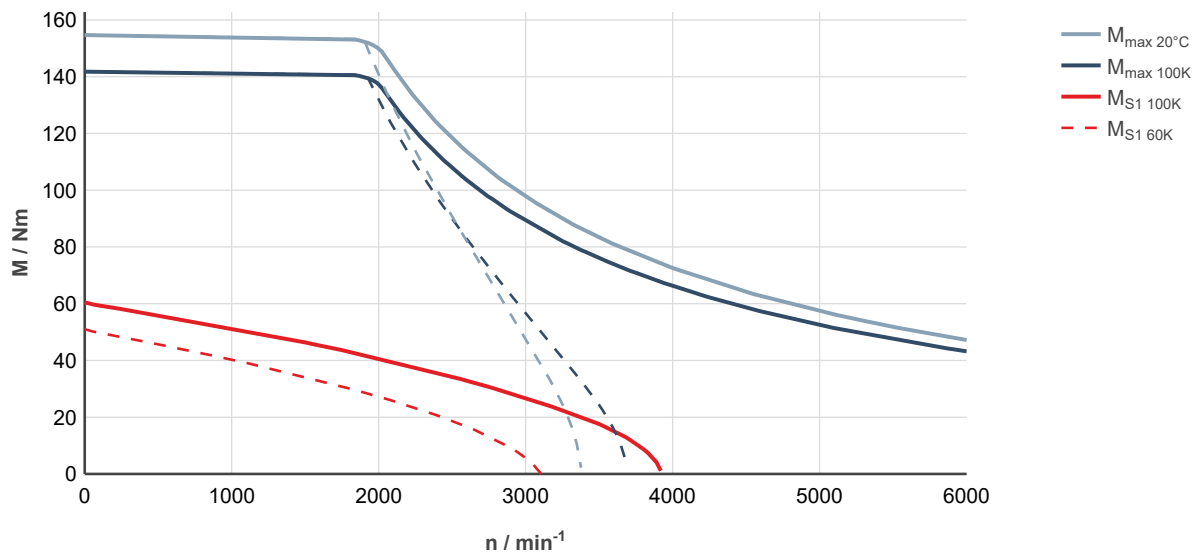

Fig. 204: MS2N10-D0BNN-___0-___-_, ctrlX DRIVE, uncontrolled supply 3 × AC 400 V

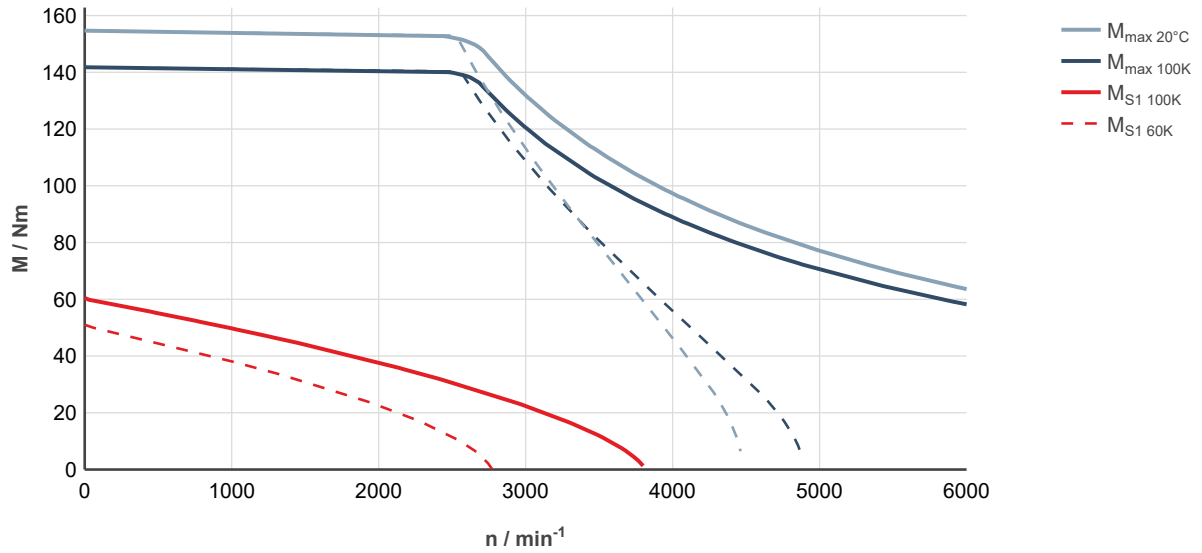

Fig. 205: MS2N10-D0BNN-___0-___-_, ctrlX DRIVE, controlled supply 3 × AC 400 ... 480 V

MS2N10-D1BFN

Designation	Symbol	Unit	MS2N10-D1BFN-__0-_N	MS2N10-D1BFN-__2-_N
Standstill torque - 60K ¹⁾	M _{0 60K}	Nm	47.2	
Standstill current - 60K	I _{0 60K}	A	14.3	
Standstill torque - 100K ¹⁾	M _{0 100K}	Nm	56.0	
Standstill current - 100K	I _{0 100K}	A	17.2	
Moment of inertia of rotor ¹⁾	J _{rot}	kg*m ²	0.0171	0.01857
Rated speed - 100K	n _{N 100K}	1/min	1600	
Rated torque - 100K ¹⁾	M _{N 100K}	Nm	43.8	
Rated current - 100K	I _{N 100K}	A	13.75	
Rated power - 100K ¹⁾	P _{N 100K}	kW	7.35	
Maximum torque 20 °C (cold) ¹⁾	M _{max 20°C}	Nm	174	
Maximum torque 100K (warm) ¹⁾	M _{max 100K}	Nm	160	
Maximum current	I _{max(rms)}	A	60.7	
Maximum speed (electrical)	n _{max el}	1/min	3000	
Maximum speed (mechanical)	n _{max mech}	1/min	6000	
Number of pole pairs	p		5	
Torque constant at 20 °C ¹⁾	K _m	Nm/A	3.53	
Voltage constant at 20 °C ¹⁾	K _E	V/1000 min ⁻¹	214.5	
Winding resistance at 20 °C	R ₁₂	Ohm	0.70	
Winding inductance	L _{12,min}	mH	12.2	
Leakage capacitance of the component	C _{ab}	nF	3.3	
Thermal time constant of winding	T _{th,W}	s	93.3	
Thermal time constant of motor	T _{th,M}	min	38.8	
Mass	m _{mot}	kg	36	41
Holding brake				
Holding torque	M ₄	Nm	0	53.00
Rated voltage	U _N	V	0	24
Rated current	I _N	A	0	1.00
Maximum connection time	t ₁	ms	0	70
Maximum disconnection time	t ₂	ms	0	220
1) For tolerance details refer to chapter 6.4 Tolerances			Latest amendment: 2019-07-02	

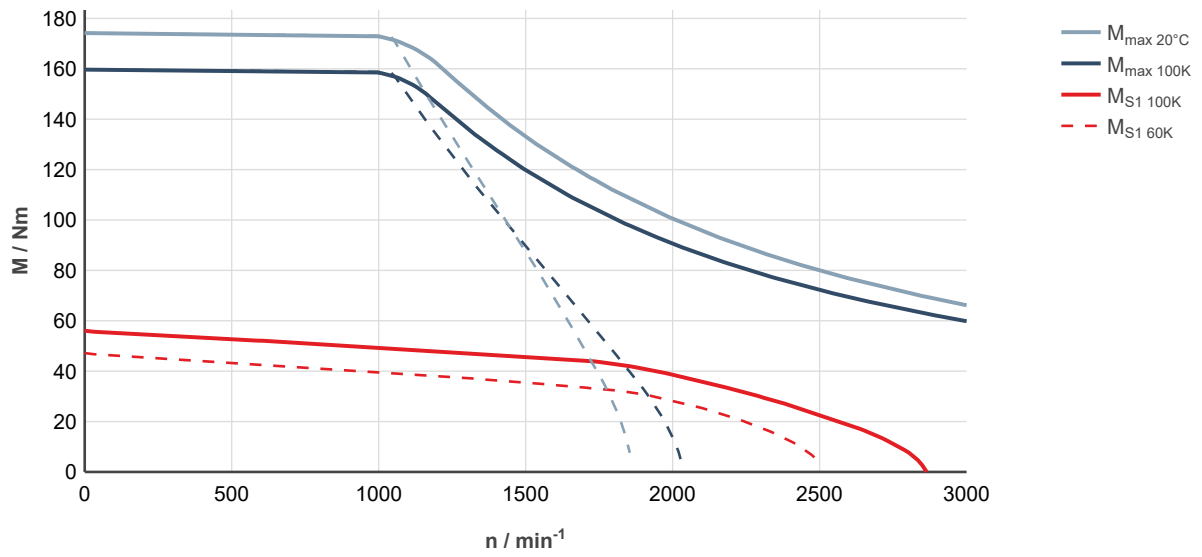

Fig. 206: MS2N10-D1BFN-___0-___-_, ctrlX DRIVE, uncontrolled supply 3 × AC 400 V

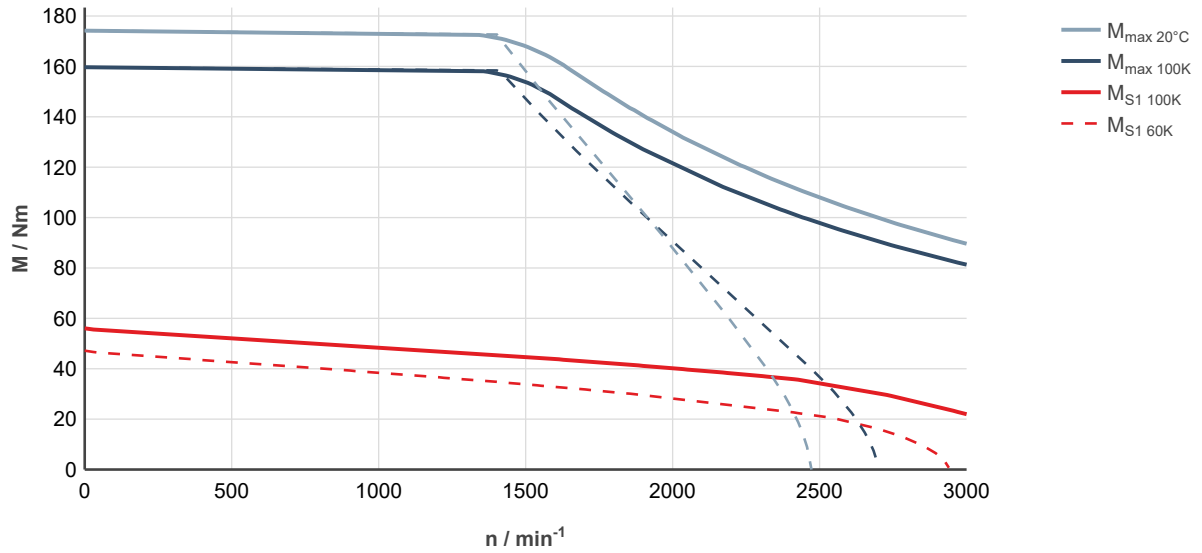

Fig. 207: MS2N10-D1BFN-___0-___-_, ctrlX DRIVE, controlled supply 3 × AC 400 ... 480 V

MS2N10-D1BNN

Designation	Symbol	Unit	MS2N10-D1BNN-__0-_N	MS2N10-D1BNN-__2-_N
Standstill torque - 60K ¹⁾	M _{0 60K}	Nm	47.2	
Standstill current - 60K	I _{0 60K}	A	28.6	
Standstill torque - 100K ¹⁾	M _{0 100K}	Nm	56.0	
Standstill current - 100K	I _{0 100K}	A	34.3	
Moment of inertia of rotor ¹⁾	J _{rot}	kg*m ²	0.0171	0.01857
Rated speed - 100K	n _{N 100K}	1/min	2460	
Rated torque - 100K ¹⁾	M _{N 100K}	Nm	24.7	
Rated current - 100K	I _{N 100K}	A	16.0	
Rated power - 100K ¹⁾	P _{N 100K}	kW	6.35	
Maximum torque 20 °C (cold) ¹⁾	M _{max 20°C}	Nm	174	
Maximum torque 100K (warm) ¹⁾	M _{max 100K}	Nm	160	
Maximum current	I _{max(rms)}	A	121.5	
Maximum speed (electrical)	n _{max el}	1/min	6000	
Maximum speed (mechanical)	n _{max mech}	1/min	6000	
Number of pole pairs	p		5	
Torque constant at 20 °C ¹⁾	K _m	Nm/A	1.76	
Voltage constant at 20 °C ¹⁾	K _E	V/1000 min ⁻¹	107.6	
Winding resistance at 20 °C	R ₁₂	Ohm	0.178	
Winding inductance	L _{12,min}	mH	3.23	
Leakage capacitance of the component	C _{ab}	nF	3.33	
Thermal time constant of winding	T _{th,W}	s	93.3	
Thermal time constant of motor	T _{th,M}	min	38.8	
Mass	m _{mot}	kg	36	41
Holding brake				
Holding torque	M ₄	Nm	0	53.00
Rated voltage	U _N	V	0	24
Rated current	I _N	A	0	1.00
Maximum connection time	t ₁	ms	0	70
Maximum disconnection time	t ₂	ms	0	220

1) For tolerance details refer to [chapter 6.4 Tolerances](#) Latest amendment: 2019-07-02

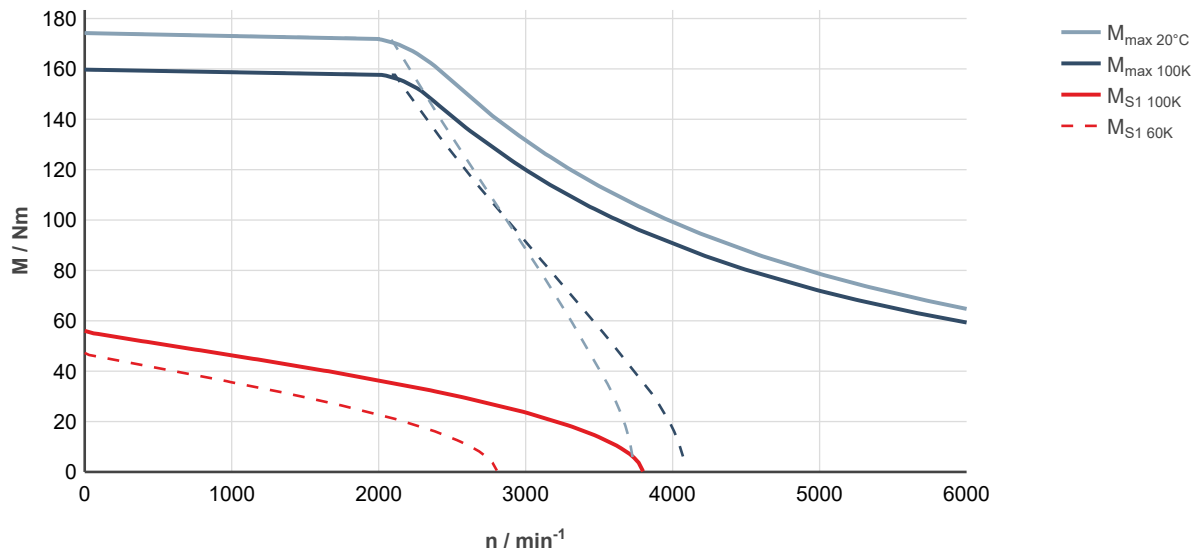

Fig. 208: MS2N10-D1BNN-___0-___-_, ctrlX DRIVE, uncontrolled supply 3 × AC 400 V

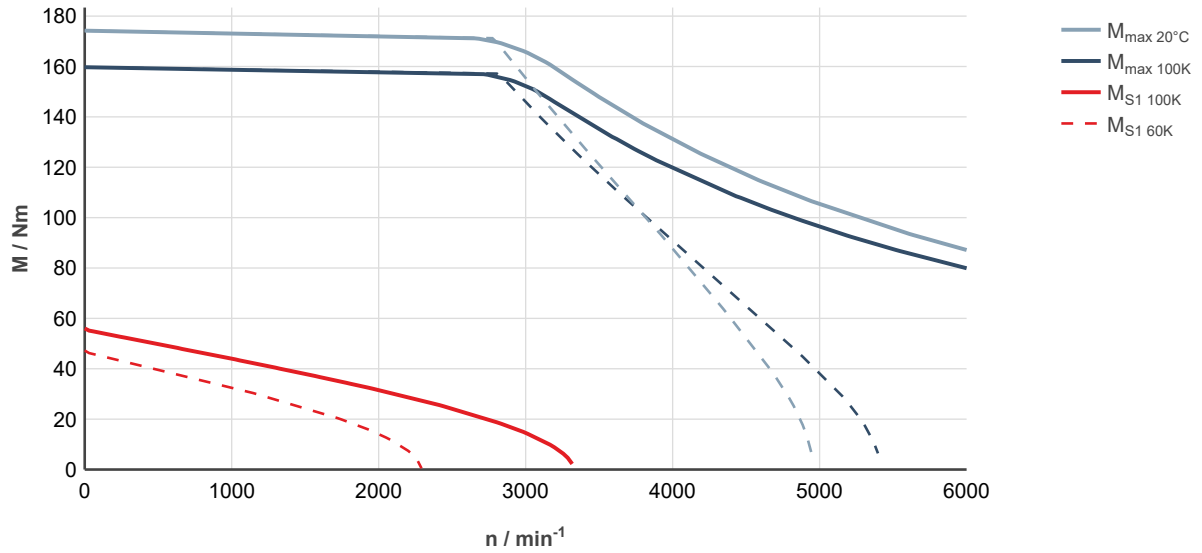

Fig. 209: MS2N10-D1BNN-___0-___-_, ctrlX DRIVE, controlled supply 3 × AC 400 ... 480 V

MS2N10-E0BHN

Designation	Symbol	Unit	MS2N10-E0BHN-__0-_N	MS2N10-E0BHN-__3-_N
Standstill torque - 60K ¹⁾	M _{0 60K}	Nm	67.7	
Standstill current - 60K	I _{0 60K}	A	25.0	
Standstill torque - 100K ¹⁾	M _{0 100K}	Nm	82.5	
Standstill current - 100K	I _{0 100K}	A	31.0	
Moment of inertia of rotor ¹⁾	J _{rot}	kg*m ²	0.0114	0.0141
Rated speed - 100K	n _{N 100K}	1/min	2000	
Rated torque - 100K ¹⁾	M _{N 100K}	Nm	53.2	
Rated current - 100K	I _{N 100K}	A	20.5	
Rated power - 100K ¹⁾	P _{N 100K}	kW	11.15	
Maximum torque 20 °C (cold) ¹⁾	M _{max 20°C}	Nm	234	
Maximum torque 100K (warm) ¹⁾	M _{max 100K}	Nm	214	
Maximum current	I _{max(rms)}	A	102.5	
Maximum speed (electrical)	n _{max el}	1/min	4000	
Maximum speed (mechanical)	n _{max mech}	1/min	6000	
Number of pole pairs	p		5	
Torque constant at 20 °C ¹⁾	K _m	Nm/A	2.9	
Voltage constant at 20 °C ¹⁾	K _E	V/1000 min ⁻¹	176.4	
Winding resistance at 20 °C	R ₁₂	Ohm	0.244	
Winding inductance	L _{12,min}	mH	7.43	
Leakage capacitance of the component	C _{ab}	nF	6.2	
Thermal time constant of winding	T _{th,W}	s	122.5	
Thermal time constant of motor	T _{th,M}	min	44.6	
Mass	m _{mot}	kg	45	52
Holding brake				
Holding torque	M ₄	Nm	0	90.00
Rated voltage	U _N	V	0	24
Rated current	I _N	A	0	1.50
Maximum connection time	t ₁	ms	0	65
Maximum disconnection time	t ₂	ms	0	250

1) For tolerance details refer to [chapter 6.4 Tolerances](#)

Latest amendment: 2019-07-02

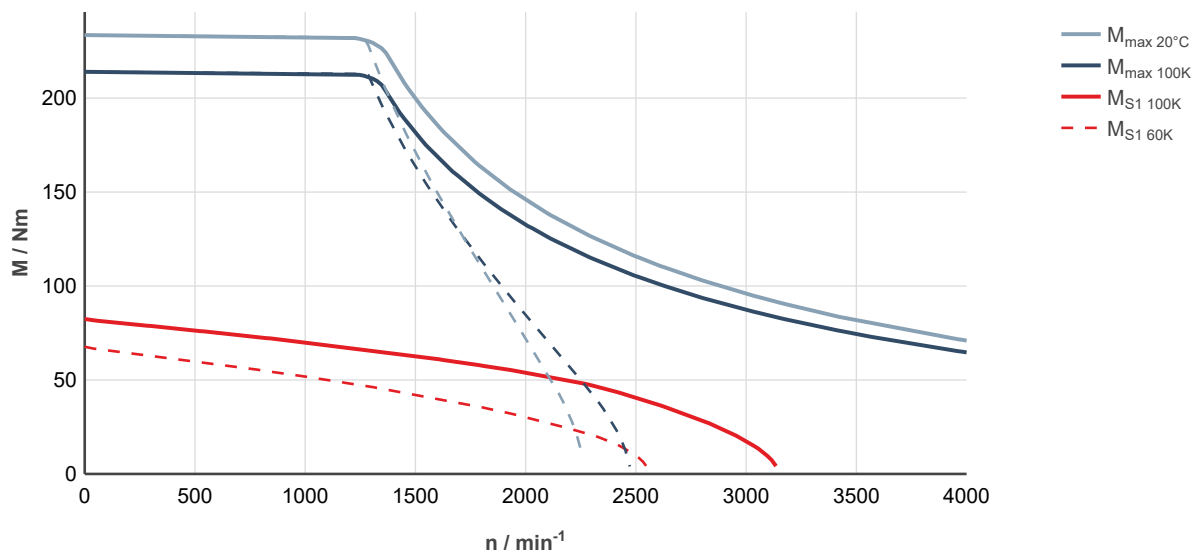

Fig. 210: MS2N10-E0BHN-___0-___-_, ctrlX DRIVE, uncontrolled supply 3 × AC 400 V

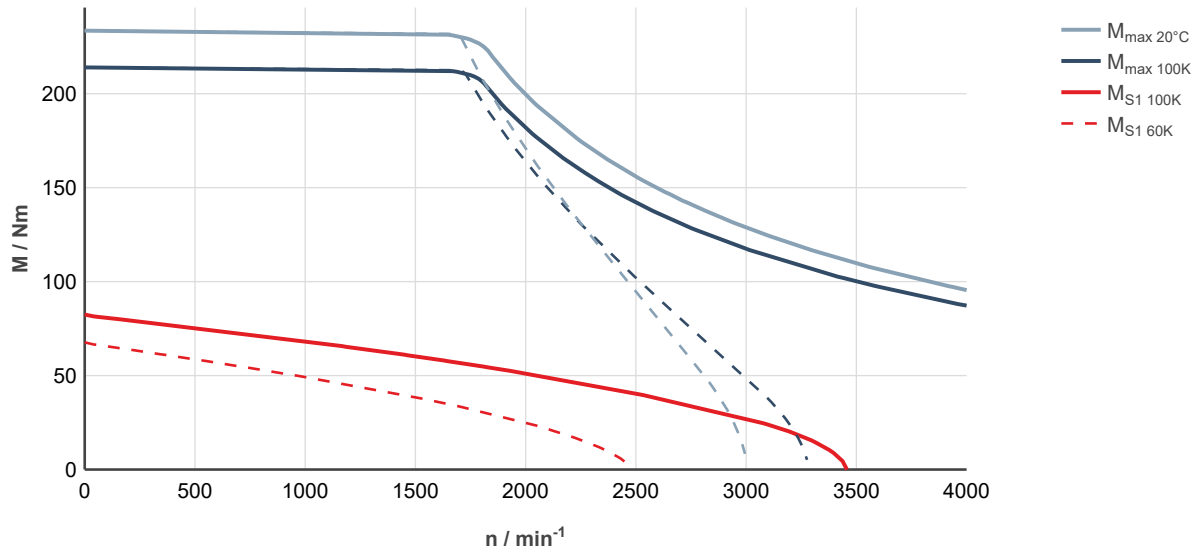

Fig. 211: MS2N10-E0BHN-___0-___-_, ctrlX DRIVE, controlled supply 3 × AC 400 ... 480 V

MS2N10-E0BNN

Designation	Symbol	Unit	MS2N10-E0BNN-__0-_N	MS2N10-E0BNN-__3-_N
Standstill torque - 60K ¹⁾	M _{0 60K}	Nm	67.7	
Standstill current - 60K	I _{0 60K}	A	34.5	
Standstill torque - 100K ¹⁾	M _{0 100K}	Nm	82.5	
Standstill current - 100K	I _{0 100K}	A	42.8	
Moment of inertia of rotor ¹⁾	J _{rot}	kg*m ²	0.0114	0.0141
Rated speed - 100K	n _{N 100K}	1/min	2120	
Rated torque - 100K ¹⁾	M _{N 100K}	Nm	41.2	
Rated current - 100K	I _{N 100K}	A	22.2	
Rated power - 100K ¹⁾	P _{N 100K}	kW	9.15	
Maximum torque 20 °C (cold) ¹⁾	M _{max 20°C}	Nm	234	
Maximum torque 100K (warm) ¹⁾	M _{max 100K}	Nm	214	
Maximum current	I _{max(rms)}	A	140	
Maximum speed (electrical)	n _{max el}	1/min	6000	
Maximum speed (mechanical)	n _{max mech}	1/min	6000	
Number of pole pairs	p		5	
Torque constant at 20 °C ¹⁾	K _m	Nm/A	2.1	
Voltage constant at 20 °C ¹⁾	K _E	V/1000 min ⁻¹	128.5	
Winding resistance at 20 °C	R ₁₂	Ohm	0.133	
Winding inductance	L _{12,min}	mH	4.00	
Leakage capacitance of the component	C _{ab}	nF	6.2	
Thermal time constant of winding	T _{th,W}	s	122.5	
Thermal time constant of motor	T _{th,M}	min	44.6	
Mass	m _{mot}	kg	45	52
Holding brake				
Holding torque	M ₄	Nm	0	90.00
Rated voltage	U _N	V	0	24
Rated current	I _N	A	0	1.50
Maximum connection time	t ₁	ms	0	65
Maximum disconnection time	t ₂	ms	0	250

1) For tolerance details refer to [chapter 6.4 Tolerances](#) Latest amendment: 2019-07-02

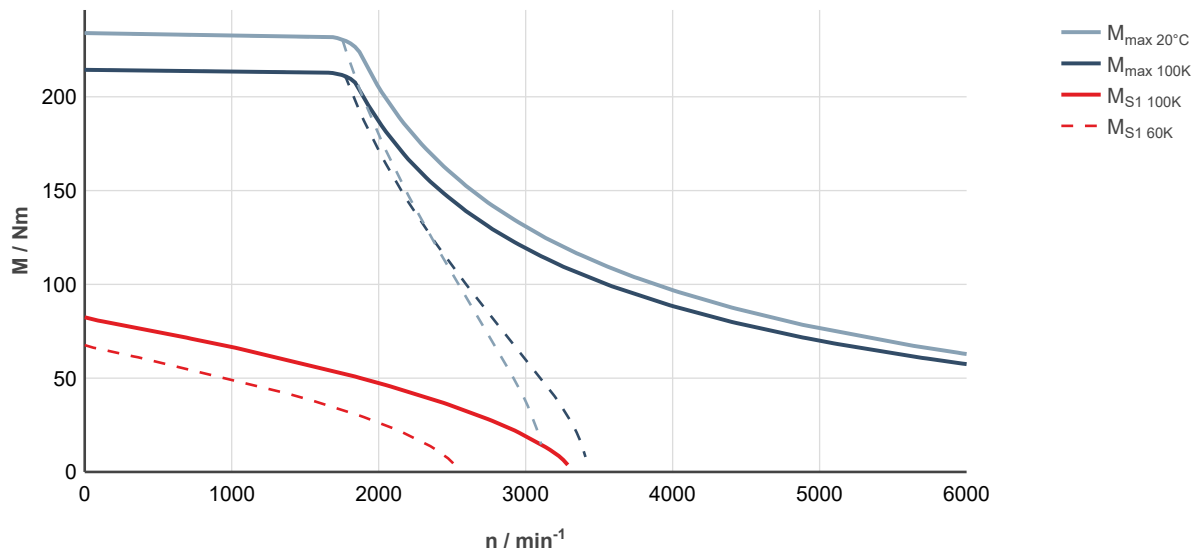

Fig. 212: MS2N10-E0BNN-___0-___-_, ctrlX DRIVE, uncontrolled supply 3 × AC 400 V

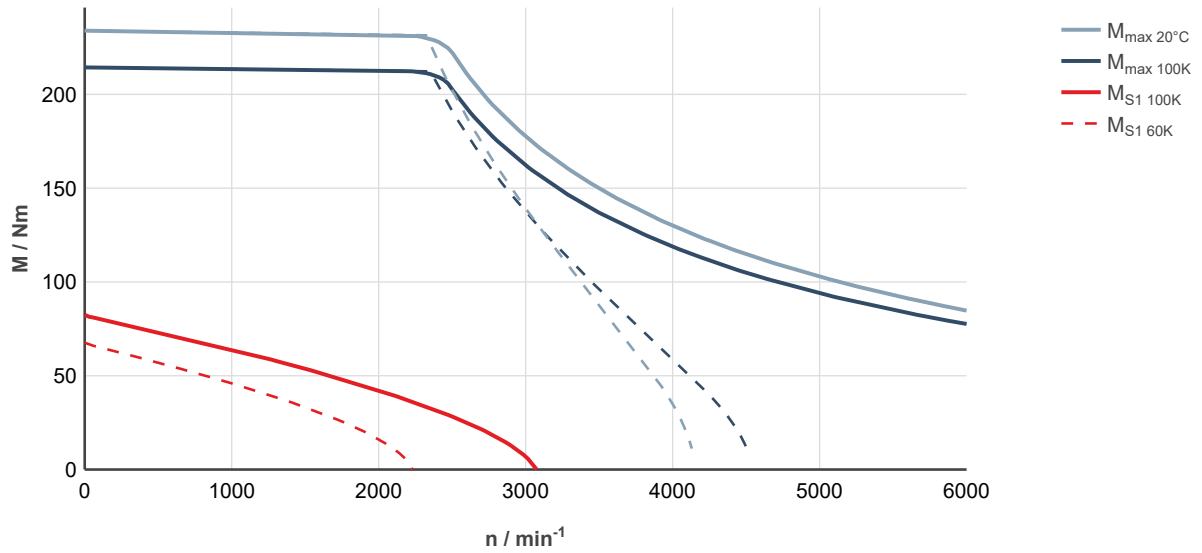

Fig. 213: MS2N10-E0BNN-___0-___-_, ctrlX DRIVE, controlled supply 3 × AC 400 ... 480 V

MS2N10-E1BFN

Designation	Symbol	Unit	MS2N10-E1BFN-__0-N	MS2N10-E1BFN-__3-N
Standstill torque - 60K ¹⁾	M _{0 60K}	Nm	64.0	
Standstill current - 60K	I _{0 60K}	A	17.1	
Standstill torque - 100K ¹⁾	M _{0 100K}	Nm	76.0	
Standstill current - 100K	I _{0 100K}	A	20.5	
Moment of inertia of rotor ¹⁾	J _{rot}	kg*m ²	0.025	0.0277
Rated speed - 100K	n _{N 100K}	1/min	1500	
Rated torque - 100K ¹⁾	M _{N 100K}	Nm	57.4	
Rated current - 100K	I _{N 100K}	A	15.9	
Rated power - 100K ¹⁾	P _{N 100K}	kW	9.0	
Maximum torque 20 °C (cold) ¹⁾	M _{max 20°C}	Nm	266	
Maximum torque 100K (warm) ¹⁾	M _{max 100K}	Nm	244	
Maximum current	I _{max(rms)}	A	81	
Maximum speed (electrical)	n _{max el}	1/min	3000	
Maximum speed (mechanical)	n _{max mech}	1/min	6000	
Number of pole pairs	p		5	
Torque constant at 20 °C ¹⁾	K _m	Nm/A	4.0	
Voltage constant at 20 °C ¹⁾	K _E	V/1000 min ⁻¹	243	
Winding resistance at 20 °C	R ₁₂	Ohm	0.53	
Winding inductance	L _{12,min}	mH	10.0	
Leakage capacitance of the component	C _{ab}	nF	5.12	
Thermal time constant of winding	T _{th,W}	s	100.5	
Thermal time constant of motor	T _{th,M}	min	44.6	
Mass	m _{mot}	kg	47	54
Holding brake				
Holding torque	M ₄	Nm	0	90.00
Rated voltage	U _N	V	0	24
Rated current	I _N	A	0	1.50
Maximum connection time	t ₁	ms	0	65
Maximum disconnection time	t ₂	ms	0	250
1) For tolerance details refer to chapter 6.4 Tolerances			Latest amendment: 2019-07-02	

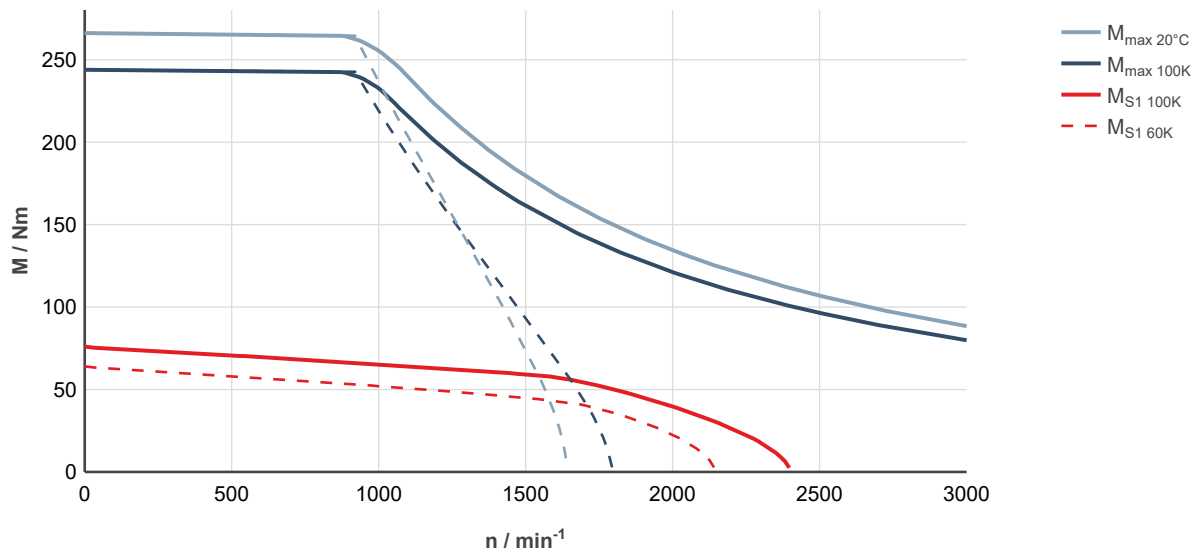

Fig. 214: MS2N10-E1BFN-___0-___-__, ctrlX DRIVE, uncontrolled supply 3 × AC 400 V

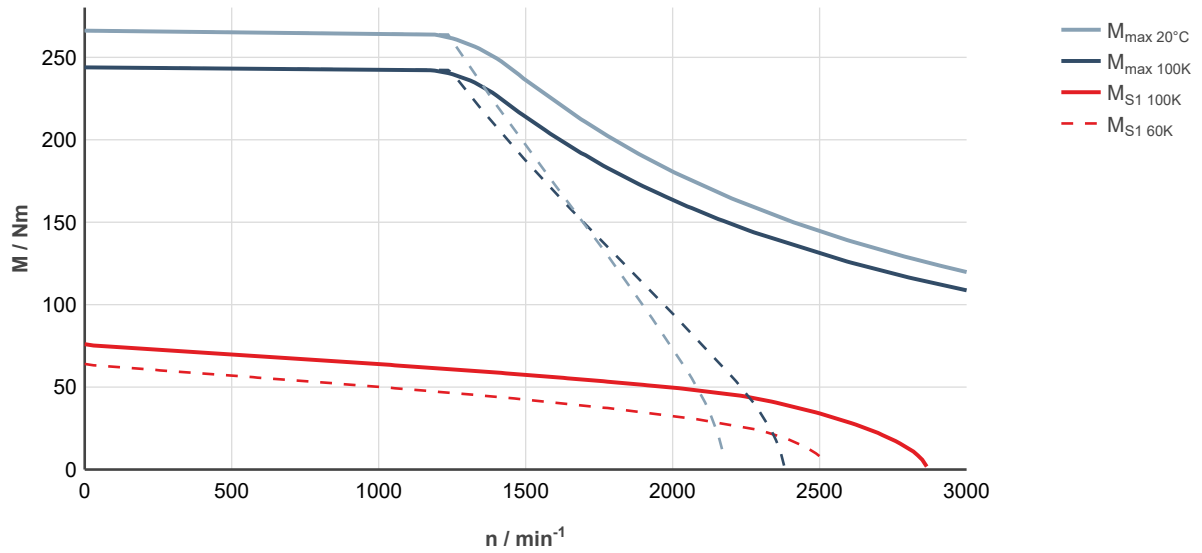

Fig. 215: MS2N10-E1BFN-___0-___-__, ctrlX DRIVE, controlled supply 3 × AC 400 ... 480 V

MS2N10-E1BNN

Designation	Symbol	Unit	MS2N10-E1BNN-__0-_N	MS2N10-E1BNN-__3-_N
Standstill torque - 60K ¹⁾	M _{0 60K}	Nm	64.0	
Standstill current - 60K	I _{0 60K}	A	34.2	
Standstill torque - 100K ¹⁾	M _{0 100K}	Nm	76.0	
Standstill current - 100K	I _{0 100K}	A	41	
Moment of inertia of rotor ¹⁾	J _{rot}	kg*m ²	0.025	0.0277
Rated speed - 100K	n _{N 100K}	1/min	1970	
Rated torque - 100K ¹⁾	M _{N 100K}	Nm	32.2	
Rated current - 100K	I _{N 100K}	A	18.3	
Rated power - 100K ¹⁾	P _{N 100K}	kW	6.65	
Maximum torque 20 °C (cold) ¹⁾	M _{max 20°C}	Nm	266	
Maximum torque 100K (warm) ¹⁾	M _{max 100K}	Nm	244	
Maximum current	I _{max(rms)}	A	162	
Maximum speed (electrical)	n _{max el}	1/min	6000	
Maximum speed (mechanical)	n _{max mech}	1/min	6000	
Number of pole pairs	p		5	
Torque constant at 20 °C ¹⁾	K _m	Nm/A	2.0	
Voltage constant at 20 °C ¹⁾	K _E	V/1000 min ⁻¹	121.6	
Winding resistance at 20 °C	R ₁₂	Ohm	0.137	
Winding inductance	L _{12,min}	mH	2.87	
Leakage capacitance of the component	C _{ab}	nF	5.0	
Thermal time constant of winding	T _{th,W}	s	100.5	
Thermal time constant of motor	T _{th,M}	min	44.6	
Mass	m _{mot}	kg	47	54
Holding brake				
Holding torque	M ₄	Nm	0	90.00
Rated voltage	U _N	V	0	24
Rated current	I _N	A	0	1.50
Maximum connection time	t ₁	ms	0	65
Maximum disconnection time	t ₂	ms	0	250

1) For tolerance details refer to [chapter 6.4 Tolerances](#)

Latest amendment: 2019-07-02

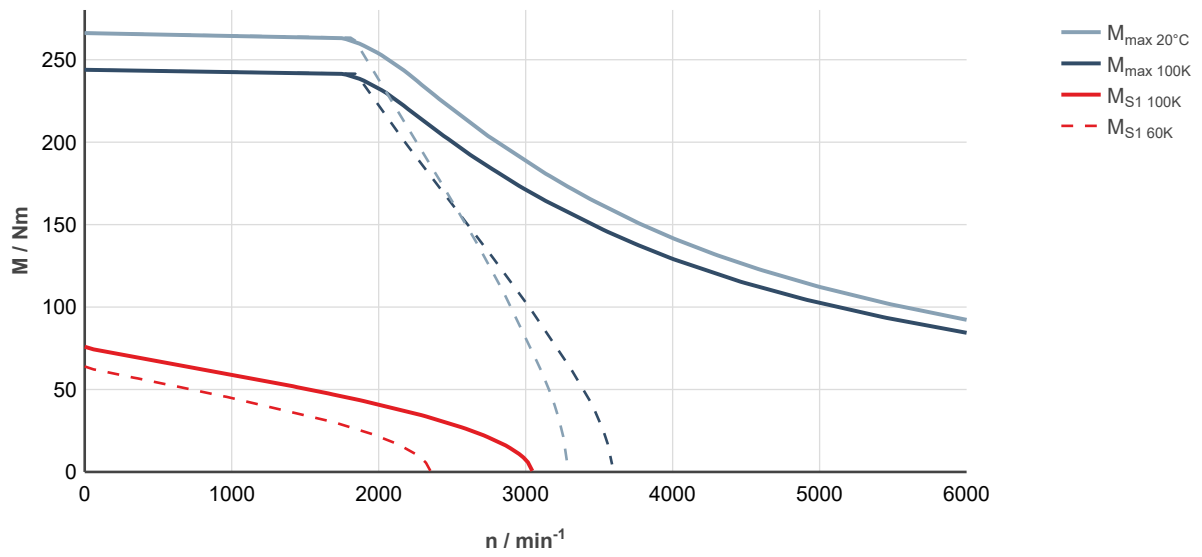

Fig. 216: MS2N10-E1BNN-___0-___-_, ctrlX DRIVE, uncontrolled supply 3 × AC 400 V

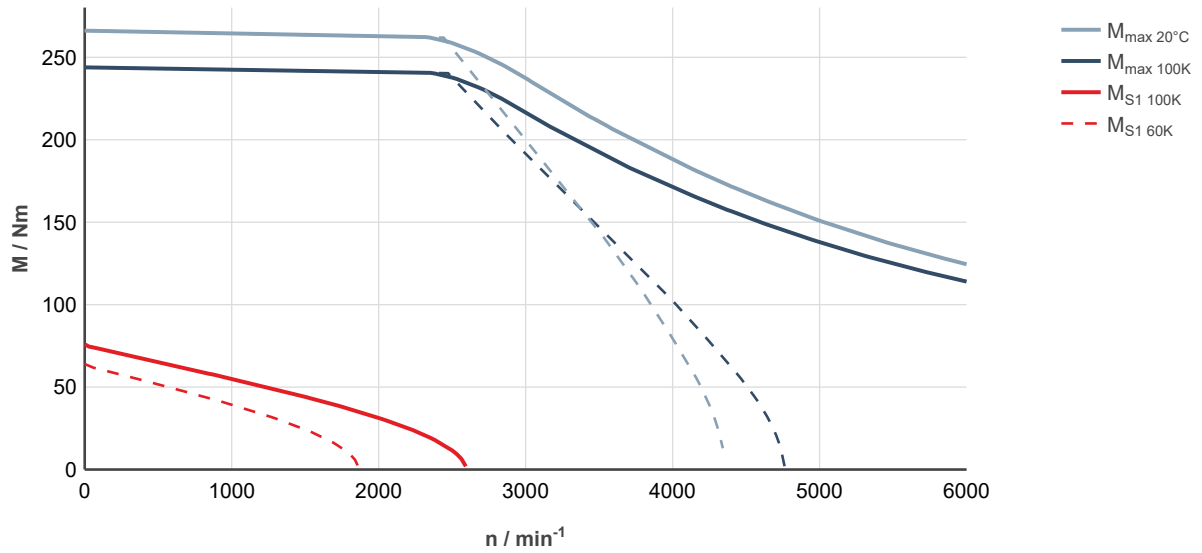

Fig. 217: MS2N10-E1BNN-___0-___-_, ctrlX DRIVE, controlled supply 3 × AC 400 ... 480 V

MS2N10-F0BDN

Designation	Symbol	Unit	MS2N10-F0BDN-__0-_N	MS2N10-F0BDN-__3-_N
Standstill torque - 60K ¹⁾	M _{0 60K}	Nm	85.0	
Standstill current - 60K	I _{0 60K}	A	15.8	
Standstill torque - 100K ¹⁾	M _{0 100K}	Nm	103	
Standstill current - 100K	I _{0 100K}	A	19.5	
Moment of inertia of rotor ¹⁾	J _{rot}	kg*m ²	0.0147	0.0174
Rated speed - 100K	n _{N 100K}	1/min	1000	
Rated torque - 100K ¹⁾	M _{N 100K}	Nm	89.6	
Rated current - 100K	I _{N 100K}	A	17.1	
Rated power - 100K ¹⁾	P _{N 100K}	kW	9.4	
Maximum torque 20 °C (cold) ¹⁾	M _{max 20°C}	Nm	313	
Maximum torque 100K (warm) ¹⁾	M _{max 100K}	Nm	287	
Maximum current	I _{max(rms)}	A	70	
Maximum speed (electrical)	n _{max el}	1/min	2000	
Maximum speed (mechanical)	n _{max mech}	1/min	6000	
Number of pole pairs	p		5	
Torque constant at 20 °C ¹⁾	K _m	Nm/A	5.76	
Voltage constant at 20 °C ¹⁾	K _E	V/1000 min ⁻¹	350	
Winding resistance at 20 °C	R ₁₂	Ohm	0.667	
Winding inductance	L _{12,min}	mH	20.05	
Leakage capacitance of the component	C _{ab}	nF	7.75	
Thermal time constant of winding	T _{th,W}	s	128.6	
Thermal time constant of motor	T _{th,M}	min	49.5	
Mass	m _{mot}	kg	55	62
Holding brake				
Holding torque	M ₄	Nm	0	90.00
Rated voltage	U _N	V	0	24
Rated current	I _N	A	0	1.50
Maximum connection time	t ₁	ms	0	65
Maximum disconnection time	t ₂	ms	0	250

1) For tolerance details refer to [chapter 6.4 Tolerances](#)

Latest amendment: 2019-07-02

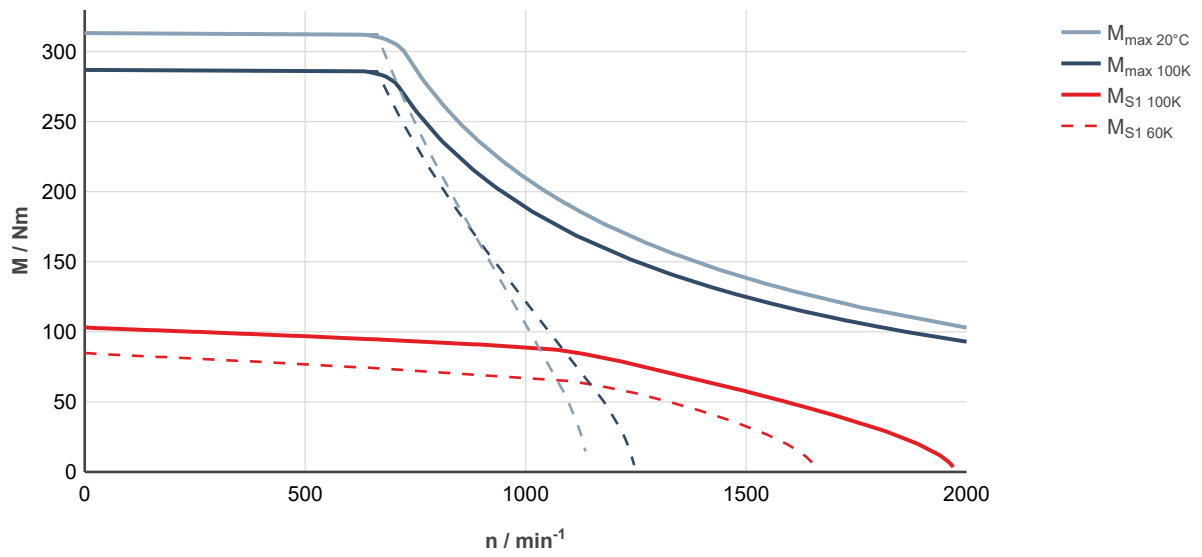

Fig. 218: MS2N10-F0BDN-___0-___-_, ctrlX DRIVE, uncontrolled supply 3 × AC 400 V

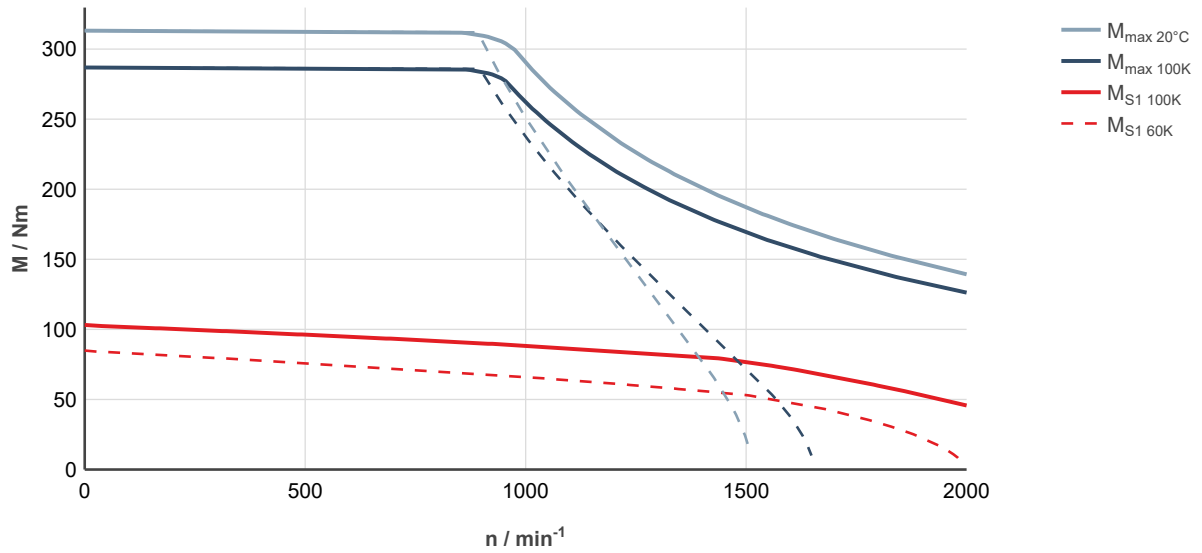

Fig. 219: MS2N10-F0BDN-___0-___-_, ctrlX DRIVE, controlled supply 3 × AC 400 ... 480 V

MS2N10-F0BHN

Designation	Symbol	Unit	MS2N10-F0BHN-__0-_N	MS2N10-F0BHN-__3-_N
Standstill torque - 60K ¹⁾	M _{0 60K}	Nm	85	
Standstill current - 60K	I _{0 60K}	A	32.0	
Standstill torque - 100K ¹⁾	M _{0 100K}	Nm	103	
Standstill current - 100K	I _{0 100K}	A	39.4	
Moment of inertia of rotor ¹⁾	J _{rot}	kg*m ²	0.0147	0.0174
Rated speed - 100K	n _{N 100K}	1/min	2000	
Rated torque - 100K ¹⁾	M _{N 100K}	Nm	56.7	
Rated current - 100K	I _{N 100K}	A	22.4	
Rated power - 100K ¹⁾	P _{N 100K}	kW	11.85	
Maximum torque 20 °C (cold) ¹⁾	M _{max 20°C}	Nm	313	
Maximum torque 100K (warm) ¹⁾	M _{max 100K}	Nm	287	
Maximum current	I _{max(rms)}	A	140	
Maximum speed (electrical)	n _{max el}	1/min	4000	
Maximum speed (mechanical)	n _{max mech}	1/min	6000	
Number of pole pairs	p		5	
Torque constant at 20 °C ¹⁾	K _m	Nm/A	2.84	
Voltage constant at 20 °C ¹⁾	K _E	V/1000 min ⁻¹	172.5	
Winding resistance at 20 °C	R ₁₂	Ohm	0.169	
Winding inductance	L _{12,min}	mH	5.01	
Leakage capacitance of the component	C _{ab}	nF	8.7	
Thermal time constant of winding	T _{th,W}	s	128.6	
Thermal time constant of motor	T _{th,M}	min	49.5	
Mass	m _{mot}	kg	55	62
Holding brake				
Holding torque	M ₄	Nm	0	90.00
Rated voltage	U _N	V	0	24
Rated current	I _N	A	0	1.50
Maximum connection time	t ₁	ms	0	65
Maximum disconnection time	t ₂	ms	0	250

1) For tolerance details refer to [chapter 6.4 Tolerances](#) Latest amendment: 2019-07-02

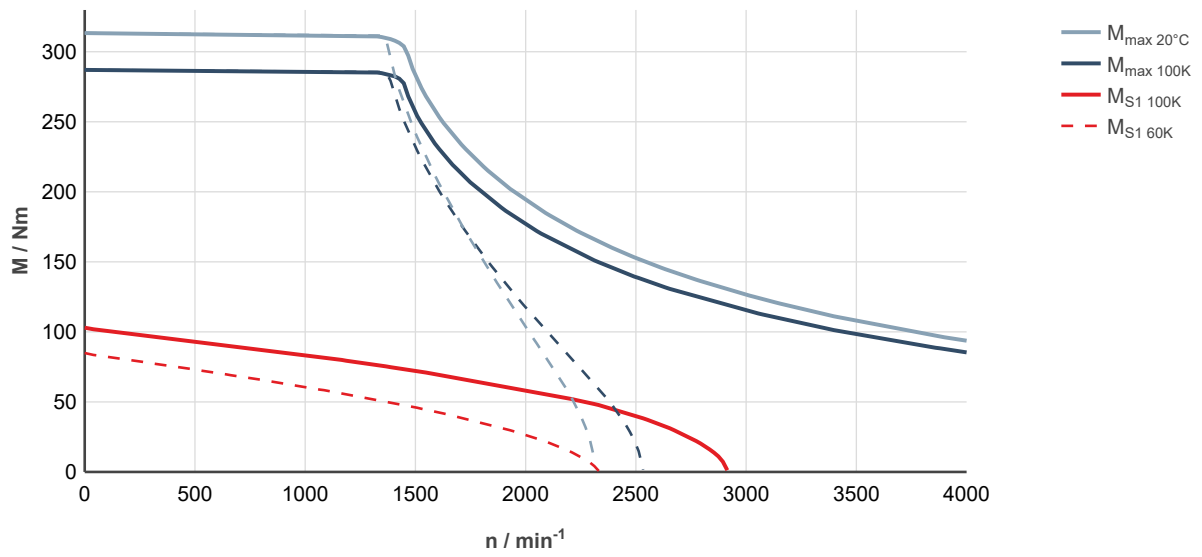

Fig. 220: MS2N10-F0BHN-___0-___-_, ctrlX DRIVE, uncontrolled supply 3 × AC 400 V

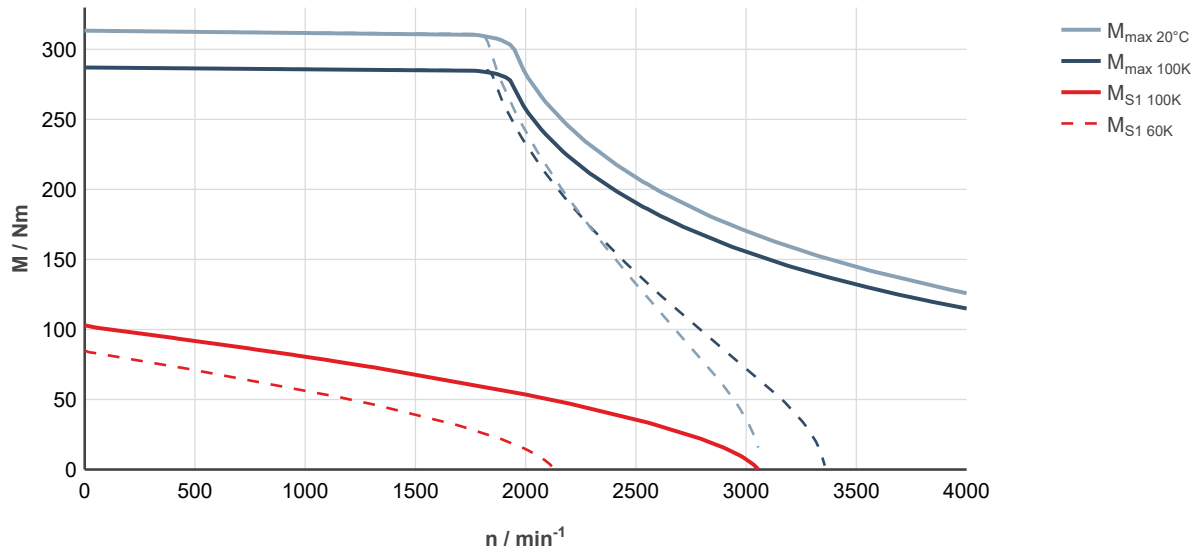

Fig. 221: MS2N10-F0BHN-___0-___-_, ctrlX DRIVE, controlled supply 3 × AC 400 ... 480 V

MS2N10-F1BDN

Designation	Symbol	Unit	MS2N10-F1BDN-__0-_N	MS2N10-F1BDN-__3-_N
Standstill torque - 60K ¹⁾	M _{0 60K}	Nm	79.5	
Standstill current - 60K	I _{0 60K}	A	15.9	
Standstill torque - 100K ¹⁾	M _{0 100K}	Nm	96.5	
Standstill current - 100K	I _{0 100K}	A	19.5	
Moment of inertia of rotor ¹⁾	J _{rot}	kg*m ²	0.0329	0.0356
Rated speed - 100K	n _{N 100K}	1/min	1000	
Rated torque - 100K ¹⁾	M _{N 100K}	Nm	81.9	
Rated current - 100K	I _{N 100K}	A	16.8	
Rated power - 100K ¹⁾	P _{N 100K}	kW	8.6	
Maximum torque 20 °C (cold) ¹⁾	M _{max 20°C}	Nm	360	
Maximum torque 100K (warm) ¹⁾	M _{max 100K}	Nm	330	
Maximum current	I _{max(rms)}	A	81.0	
Maximum speed (electrical)	n _{max el}	1/min	2000	
Maximum speed (mechanical)	n _{max mech}	1/min	6000	
Number of pole pairs	p		5	
Torque constant at 20 °C ¹⁾	K _m	Nm/A	5.36	
Voltage constant at 20 °C ¹⁾	K _E	V/1000 min ⁻¹	325.5	
Winding resistance at 20 °C	R ₁₂	Ohm	0.678	
Winding inductance	L _{12,min}	mH	14.6	
Leakage capacitance of the component	C _{ab}	nF	6.8	
Thermal time constant of winding	T _{th,W}	s	102	
Thermal time constant of motor	T _{th,M}	min	49.5	
Mass	m _{mot}	kg	59.0	66
Holding brake				
Holding torque	M ₄	Nm	0	90.00
Rated voltage	U _N	V	0	24
Rated current	I _N	A	0	1.50
Maximum connection time	t ₁	ms	0	65
Maximum disconnection time	t ₂	ms	0	250

1) For tolerance details refer to [chapter 6.4 Tolerances](#)

Latest amendment: 2019-07-02

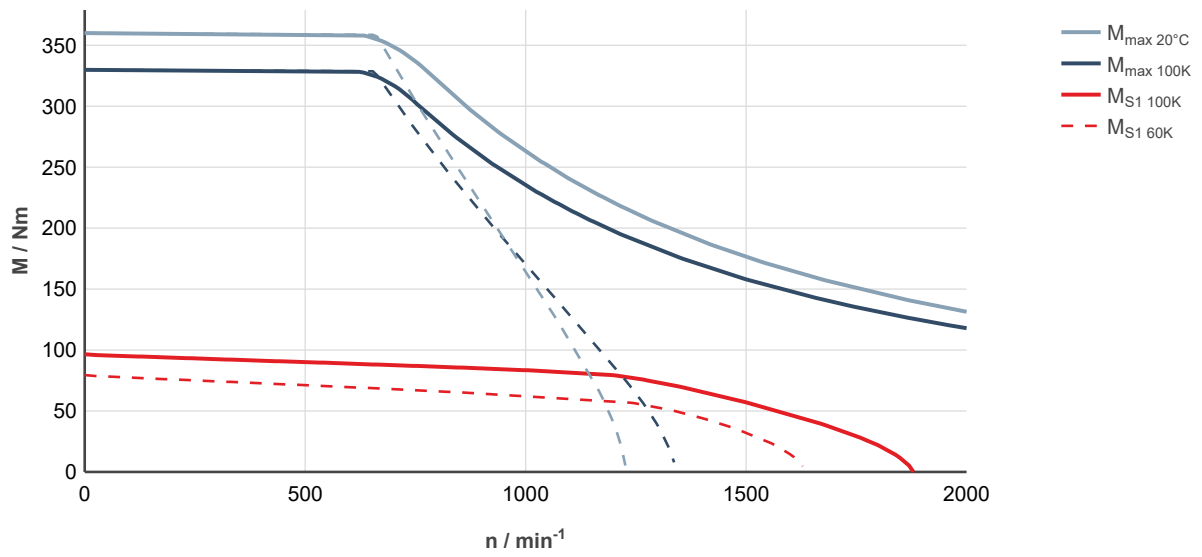

Fig. 222: MS2N10-F1BDN-___0-___-_, ctrlX DRIVE, uncontrolled supply 3 × AC 400 V

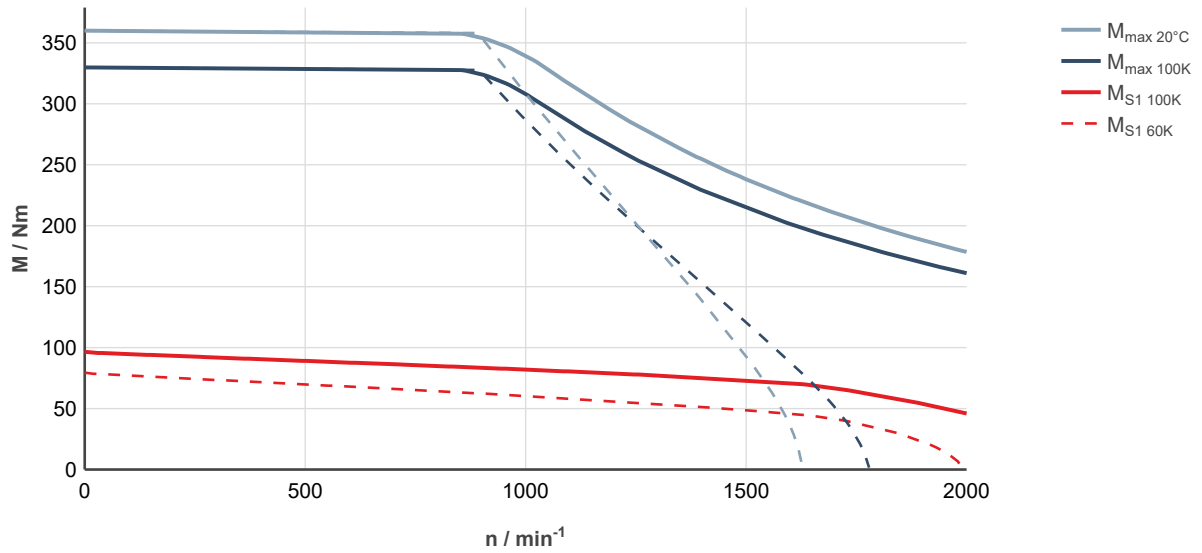

Fig. 223: MS2N10-F1BDN-___0-___-_, ctrlX DRIVE, controlled supply 3 × AC 400 ... 480 V

MS2N10-F1BHN

Designation	Symbol	Unit	MS2N10-F1BHN-__0-_N	MS2N10-F1BHN-__3-_N
Standstill torque - 60K ¹⁾	M _{0 60K}	Nm	79.5	
Standstill current - 60K	I _{0 60K}	A	31.8	
Standstill torque - 100K ¹⁾	M _{0 100K}	Nm	96.5	
Standstill current - 100K	I _{0 100K}	A	38.9	
Moment of inertia of rotor ¹⁾	J _{rot}	kg*m ²	0.0329	0.0356
Rated speed - 100K	n _{N 100K}	1/min	2000	
Rated torque - 100K ¹⁾	M _{N 100K}	Nm	44.4	
Rated current - 100K	I _{N 100K}	A	18.9	
Rated power - 100K ¹⁾	P _{N 100K}	kW	9.3	
Maximum torque 20 °C (cold) ¹⁾	M _{max 20°C}	Nm	360	
Maximum torque 100K (warm) ¹⁾	M _{max 100K}	Nm	330	
Maximum current	I _{max(rms)}	A	162	
Maximum speed (electrical)	n _{max el}	1/min	4000	
Maximum speed (mechanical)	n _{max mech}	1/min	6000	
Number of pole pairs	p		5	
Torque constant at 20 °C ¹⁾	K _m	Nm/A	2.7	
Voltage constant at 20 °C ¹⁾	K _E	V/1000 min ⁻¹	163.9	
Winding resistance at 20 °C	R ₁₂	Ohm	0.174	
Winding inductance	L _{12,min}	mH	3.61	
Leakage capacitance of the component	C _{ab}	nF	6.70	
Thermal time constant of winding	T _{th,W}	s	102	
Thermal time constant of motor	T _{th,M}	min	49.5	
Mass	m _{mot}	kg	59.0	66
Holding brake				
Holding torque	M ₄	Nm	0	90.00
Rated voltage	U _N	V	0	24
Rated current	I _N	A	0	1.50
Maximum connection time	t ₁	ms	0	65
Maximum disconnection time	t ₂	ms	0	250

1) For tolerance details refer to [chapter 6.4 Tolerances](#) Latest amendment: 2019-07-02

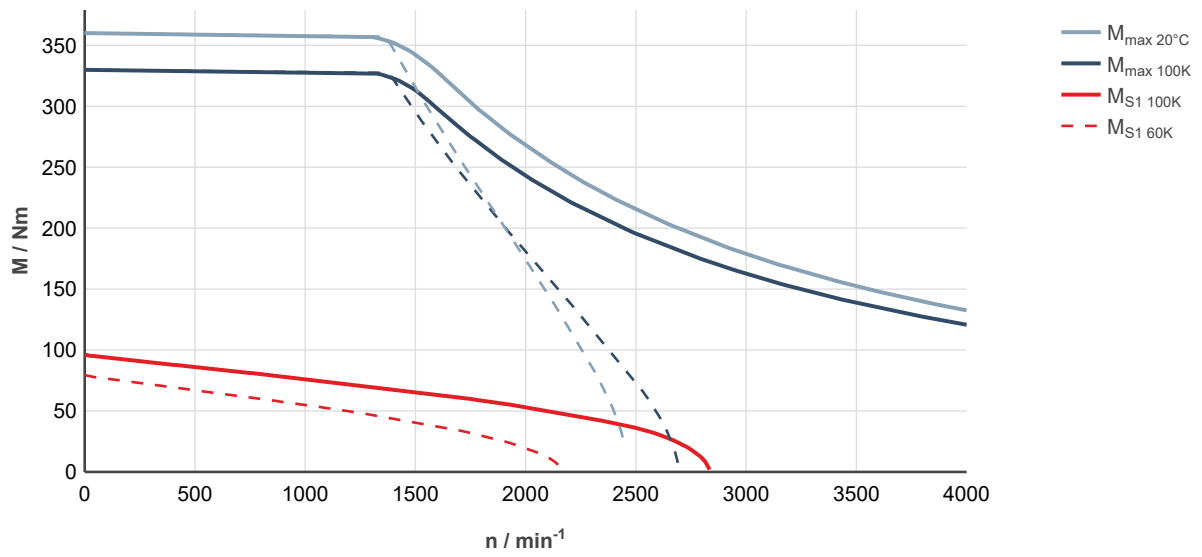

Fig. 224: MS2N10-F1BHN-___0-___-_, ctrlX DRIVE, uncontrolled supply 3 × AC 400 V

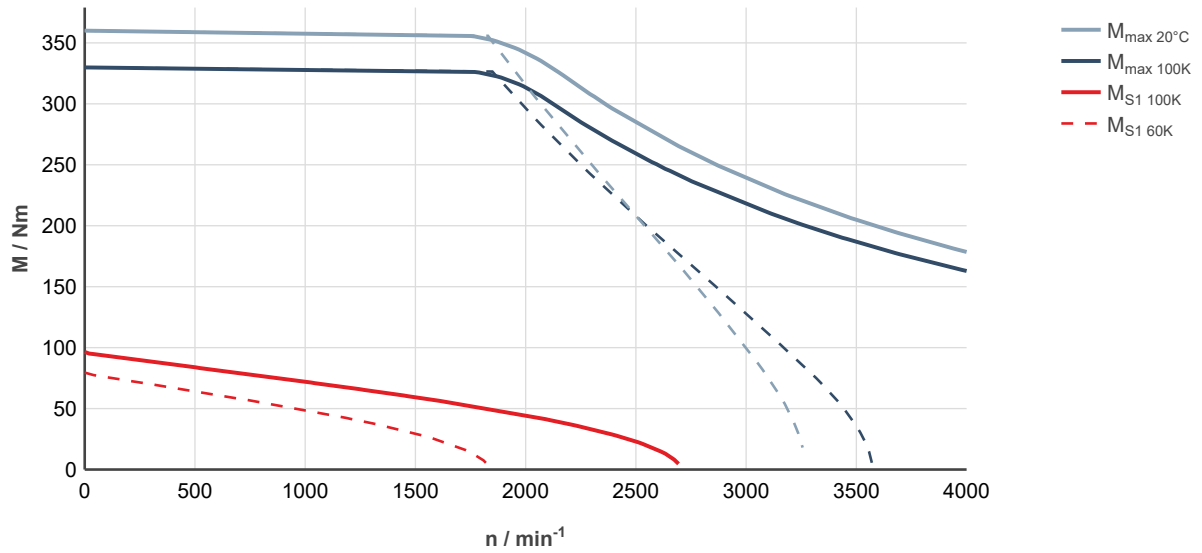

Fig. 225: MS2N10-F1BHN-___0-___-_, ctrlX DRIVE, controlled supply 3 × AC 400 ... 480 V

MS2N10-R0BQN

Designation	Symbol	Unit	MS2N10-R0BQN-__0-_N	MS2N10-R0BQN-__3-_N
Standstill torque - 60K ¹⁾	M _{0 60K}	Nm	74.5	
Standstill current - 60K	I _{0 60K}	A	58.7	
Standstill torque - 100K ¹⁾	M _{0 100K}	Nm	88.0	
Standstill current - 100K	I _{0 100K}	A	69.8	
Moment of inertia of rotor ¹⁾	J _{rot}	kg*m ²	0.0147	In preparation
Rated speed - 100K	n _{N 100K}	1/min	1300	
Rated torque - 100K ¹⁾	M _{N 100K}	Nm	40.8	
Rated current - 100K	I _{N 100K}	A	34.2	
Rated power - 100K ¹⁾	P _{N 100K}	kW	5.55	
Maximum torque 20 °C (cold) ¹⁾	M _{max 20°C}	Nm	355	
Maximum torque 100K (warm) ¹⁾	M _{max 100K}	Nm	325	
Maximum current	I _{max(rms)}	A	330	
Maximum speed (electrical)	n _{max el}	1/min	6000	
Maximum speed (mechanical)	n _{max mech}	1/min	6000	
Number of pole pairs	p		5	
Torque constant at 20 °C ¹⁾	K _m	Nm/A	1.37	
Voltage constant at 20 °C ¹⁾	K _E	V/1000 min ⁻¹	81.8	
Winding resistance at 20 °C	R ₁₂	Ohm	0.05	
Winding inductance	L _{12,min}	mH	0.765	
Leakage capacitance of the component	C _{ab}	nF	13.5	
Thermal time constant of winding	T _{th,W}	s	128.6	
Thermal time constant of motor	T _{th,M}	min	49.5	
Mass	m _{mot}	kg	56.0	In preparation
Holding brake				
Holding torque	M ₄	Nm	0	In preparation
Rated voltage	U _N	V	0	In preparation
Rated current	I _N	A	0	In preparation
Maximum connection time	t ₁	ms	0	In preparation
Maximum disconnection time	t ₂	ms	0	In preparation
1) For tolerance details refer to chapter 6.4 Tolerances			Latest amendment: 2020-11-25	

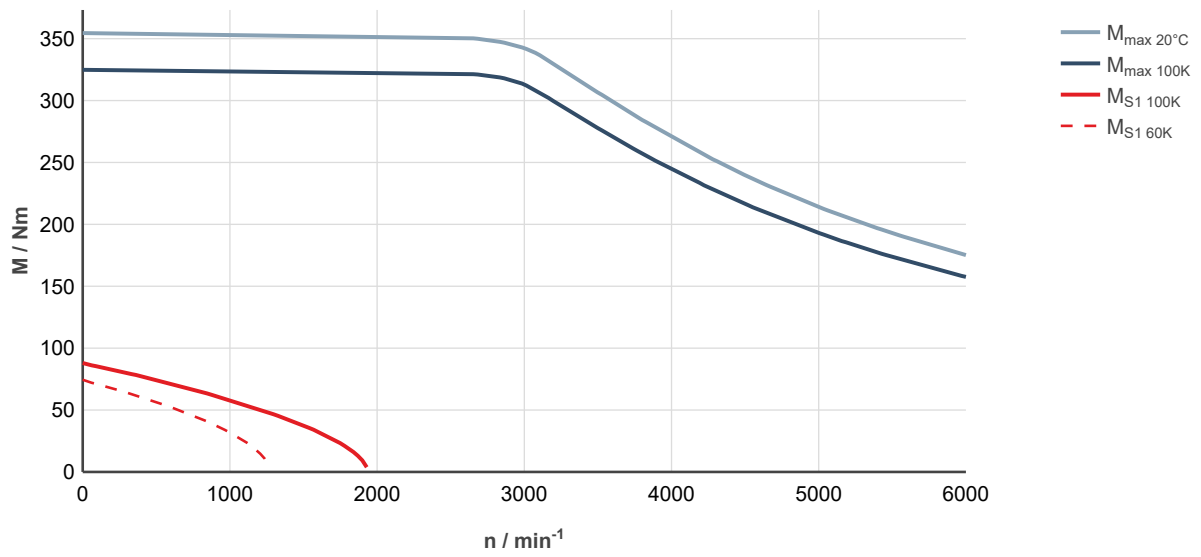

Fig. 226: MS2N10-R0BQN-___0-N___-, ctrlX DRIVE, uncontrolled supply 3 × AC 400 V

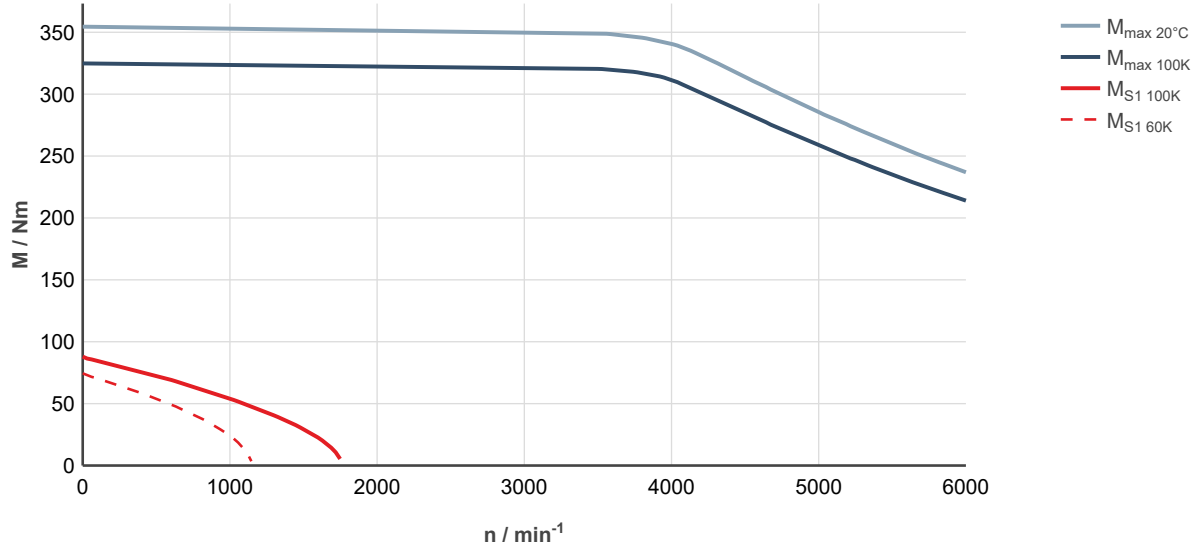

Fig. 227: MS2N10-R0BQN-___0-N___-, ctrlX DRIVE, controlled supply 3 x AC 400 ... 480 V

7.6.2 Forced ventilation

MS2N10-C0BHA/B

Designation	Symbol	Unit	MS2N10- C0BHA-__0- _N	MS2N10- C0BHA-__2- _N	MS2N10- C0BHB-__0- _N	MS2N10- C0BHB-__2- _N
Standstill torque - 100K ¹⁾	M _{0 100K}	Nm	43.2			
Standstill current - 100K	I _{0 100K}	A	18.8			
Moment of inertia of rotor ¹⁾	J _{rot}	kg*m ²	0.0048	0.00627	0.0048	0.00627
Rated speed - 100K	n _{N 100K}	1/min	1820			
Rated torque - 100K ¹⁾	M _{N 100K}	Nm	36.3			
Rated current - 100K	I _{N 100K}	A	15.9			
Rated power - 100K ¹⁾	P _{N 100K}	kW	6.9			
Maximum torque 20 °C (cold) ¹⁾	M _{max 20°C}	Nm	76.8			
Maximum torque 100K (warm) ¹⁾	M _{max 100K}	Nm	70.5			
Maximum current	I _{max(rms)}	A	38.5			
Maximum speed (electrical)	n _{max el}	1/min	4000			
Maximum speed (mechanical)	n _{max mech}	1/min	6000			
Number of pole pairs	p		5			
Torque constant at 20 °C ¹⁾	K _m	Nm/A	2.60			
Voltage constant at 20 °C ¹⁾	K _E	V/1000 min ⁻¹	157.8			
Winding resistance at 20 °C	R ₁₂	Ohm	0.74			
Winding inductance	L _{12_min}	mH	18.7			
Leakage capacitance of the component	C _{ab}	nF	1.9			
Thermal time constant of winding	T _{th_w}	s	81.2			
Thermal time constant of motor	T _{th_M}	min	10.4			
Mass	m _{mot}	kg	24.5	29.5	24.5	29.5
Holding brake						
Holding torque	M ₄	Nm	0	53.00	0	53.00
Rated voltage	U _N	V	0	24	0	24
Rated current	I _N	A	0	1.00	0	1.00
Maximum connection time	t ₁	ms	0	70	0	70
Maximum disconnection time	t ₂	ms	0	220	0	220
Fan data						
Rated voltage	U _N	V	230		115	
Rated current	I _N	A	0.26/0.23		0.46	
Frequency	f _N	Hz	50/60		60	
1) For tolerance details refer to chapter 6.4 Tolerances			Latest amendment: 2019-07-02			

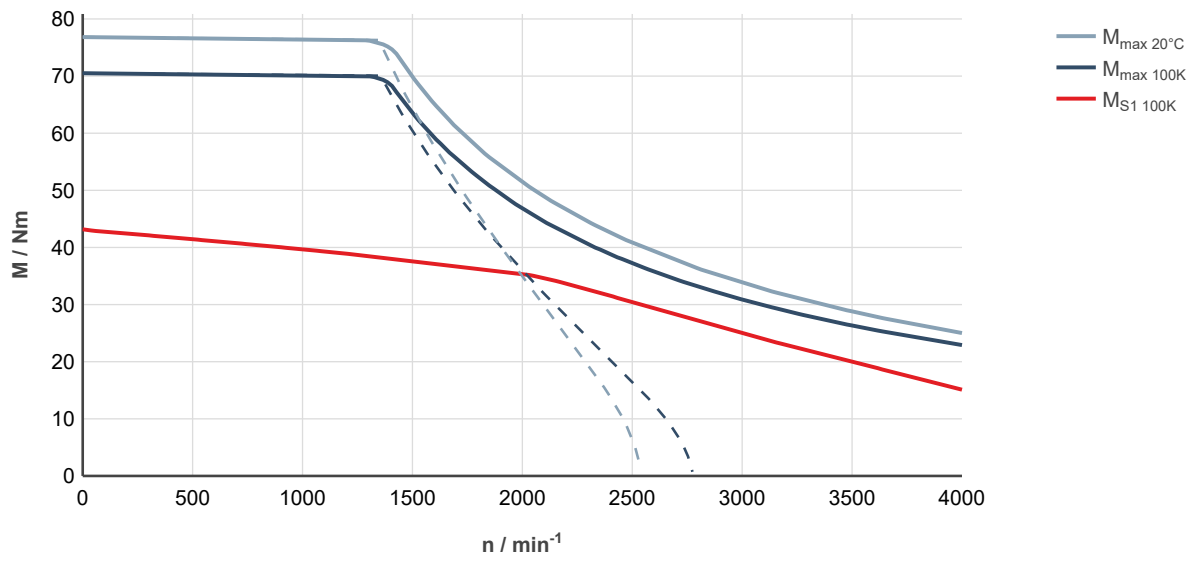

Fig. 228: MS2N10-C0BHA-___0-___-_, ctrlX DRIVE, uncontrolled supply 3 × AC 400 V

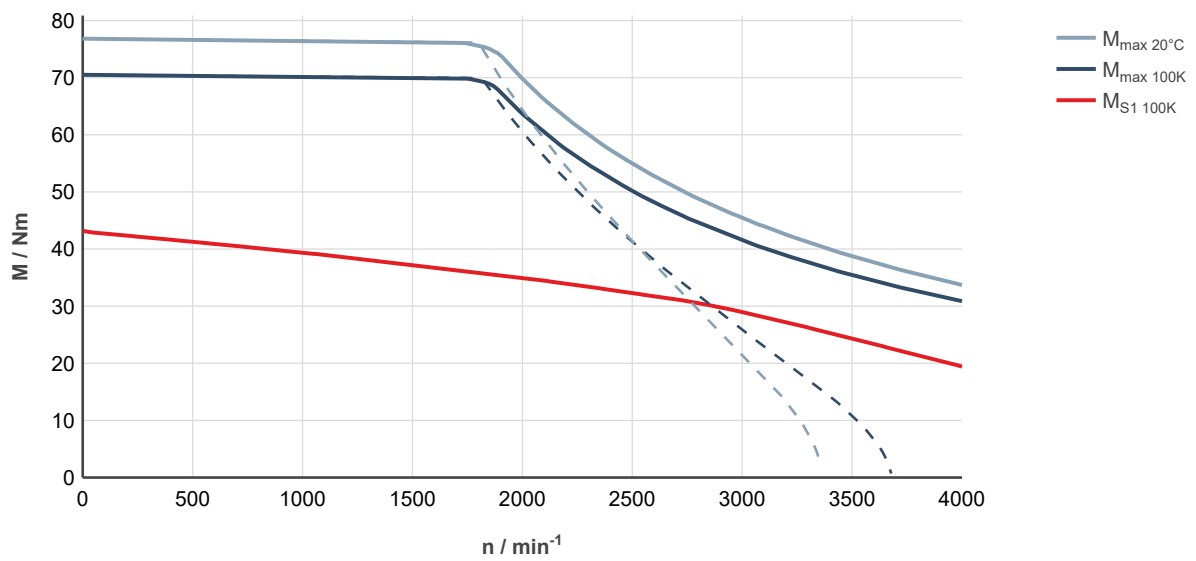

Fig. 229: MS2N10-C0BHA-___0-___-_, ctrlX DRIVE, controlled supply 3 × AC 400 ... 480 V

MS2N10-C0BNA/B

Designation	Symbol	Unit	MS2N10- C0BNA-__0- _N	MS2N10- C0BNA-__2- _N	MS2N10- C0BNB-__0- _N	MS2N10- C0BNB-__2- _N
Standstill torque - 100K ¹⁾	M _{0 100K}	Nm	43.2			
Standstill current - 100K	I _{0 100K}	A	25.1			
Moment of inertia of rotor ¹⁾	J _{rot}	kg*m ²	0.0048	0.00627	0.0048	0.00627
Rated speed - 100K	n _{N 100K}	1/min	2610			
Rated torque - 100K ¹⁾	M _{N 100K}	Nm	31.7			
Rated current - 100K	I _{N 100K}	A	18.5			
Rated power - 100K ¹⁾	P _{N 100K}	kW	8.65			
Maximum torque 20 °C (cold) ¹⁾	M _{max 20°C}	Nm	76.8			
Maximum torque 100K (warm) ¹⁾	M _{max 100K}	Nm	70.5			
Maximum current	I _{max(rms)}	A	51.3			
Maximum speed (electrical)	n _{max el}	1/min	6000			
Maximum speed (mechanical)	n _{max mech}	1/min	6000			
Number of pole pairs	p		5			
Torque constant at 20 °C ¹⁾	K _m	Nm/A	1.95			
Voltage constant at 20 °C ¹⁾	K _E	V/1000 min ⁻¹	118.4			
Winding resistance at 20 °C	R ₁₂	Ohm	0.441			
Winding inductance	L _{12_min}	mH	10.67			
Leakage capacitance of the component	C _{ab}	nF	1.97			
Thermal time constant of winding	T _{th_W}	s	81.2			
Thermal time constant of motor	T _{th_M}	min	10.4			
Mass	m _{mot}	kg	24.5	29.5	24.5	29.5
Holding brake						
Holding torque	M ₄	Nm	0	53.00	0	53.00
Rated voltage	U _N	V	0	24	0	24
Rated current	I _N	A	0	1.00	0	1.00
Maximum connection time	t ₁	ms	0	70	0	70
Maximum disconnection time	t ₂	ms	0	220	0	220
Fan data						
Rated voltage	U _N	V	230		115	
Rated current	I _N	A	0.26/0.23		0.46	
Frequency	f _N	Hz	50/60		60	
1) For tolerance details refer to chapter 6.4 Tolerances			Latest amendment: 2019-07-02			

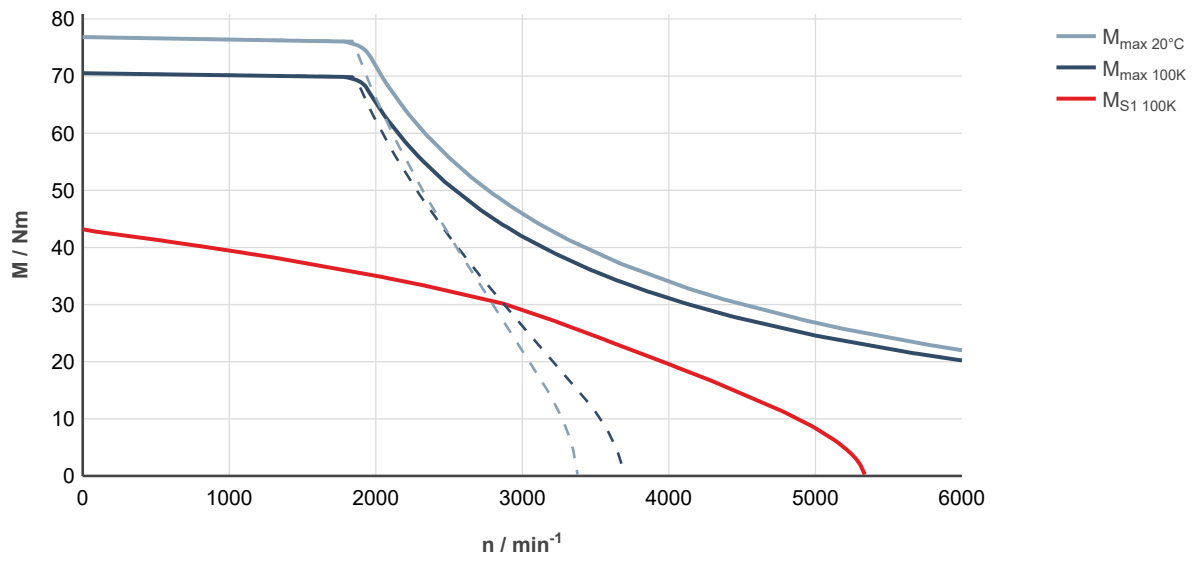

Fig. 230: MS2N10-C0BNA-___0-___-_, ctrlX DRIVE, uncontrolled supply 3 × AC 400 V

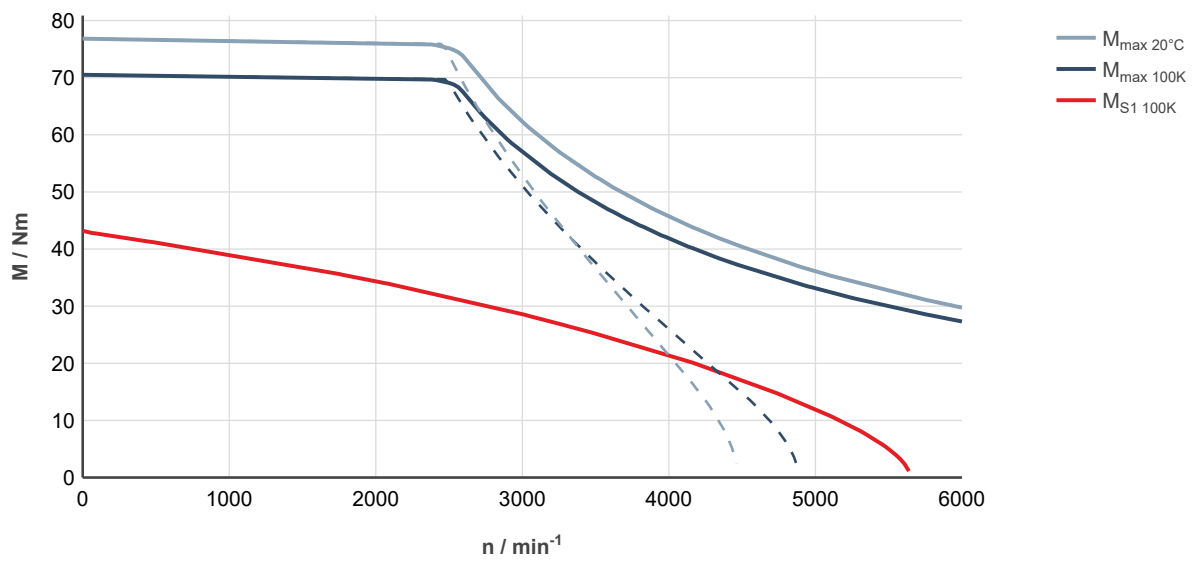

Fig. 231: MS2N10-C0BNA-___0-___-_, ctrlX DRIVE, controlled supply 3 × AC 400 ... 480 V

MS2N10-C1BHA/B

Designation	Symbol	Unit	MS2N10- C1BHA-__0- _N	MS2N10- C1BHA-__2- _N	MS2N10- C1BHB-__0- _N	MS2N10- C1BHB-__2- _N
Standstill torque - 100K ¹⁾	M _{0 100K}	Nm	40.0			
Standstill current - 100K	I _{0 100K}	A	16.7			
Moment of inertia of rotor ¹⁾	J _{rot}	kg*m ²	0.0092	0.01067	0.0092	0.01067
Rated speed - 100K	n _{N 100K}	1/min	2000			
Rated torque - 100K ¹⁾	M _{N 100K}	Nm	33.3			
Rated current - 100K	I _{N 100K}	A	14.1			
Rated power - 100K ¹⁾	P _{N 100K}	kW	6.95			
Maximum torque 20 °C (cold) ¹⁾	M _{max 20°C}	Nm	86.5			
Maximum torque 100K (warm) ¹⁾	M _{max 100K}	Nm	79.4			
Maximum current	I _{max(rms)}	A	40.9			
Maximum speed (electrical)	n _{max el}	1/min	4000			
Maximum speed (mechanical)	n _{max mech}	1/min	6000			
Number of pole pairs	p		5			
Torque constant at 20 °C ¹⁾	K _m	Nm/A	2.63			
Voltage constant at 20 °C ¹⁾	K _E	V/1000 min ⁻¹	160			
Winding resistance at 20 °C	R ₁₂	Ohm	0.96			
Winding inductance	L _{12_min}	mH	15.23			
Leakage capacitance of the component	C _{ab}	nF	1.8			
Thermal time constant of winding	T _{th_W}	s	68.5			
Thermal time constant of motor	T _{th_M}	min	10.4			
Mass	m _{mot}	kg	25	30	25	30
Holding brake						
Holding torque	M ₄	Nm	0	53.00	0	53.00
Rated voltage	U _N	V	0	24	0	24
Rated current	I _N	A	0	1.00	0	1.00
Maximum connection time	t ₁	ms	0	70	0	70
Maximum disconnection time	t ₂	ms	0	220	0	220
Fan data						
Rated voltage	U _N	V	230		115	
Rated current	I _N	A	0.26/0.23		0.46	
Frequency	f _N	Hz	50/60		60	
1) For tolerance details refer to chapter 6.4 Tolerances			Latest amendment: 2020-06-03			

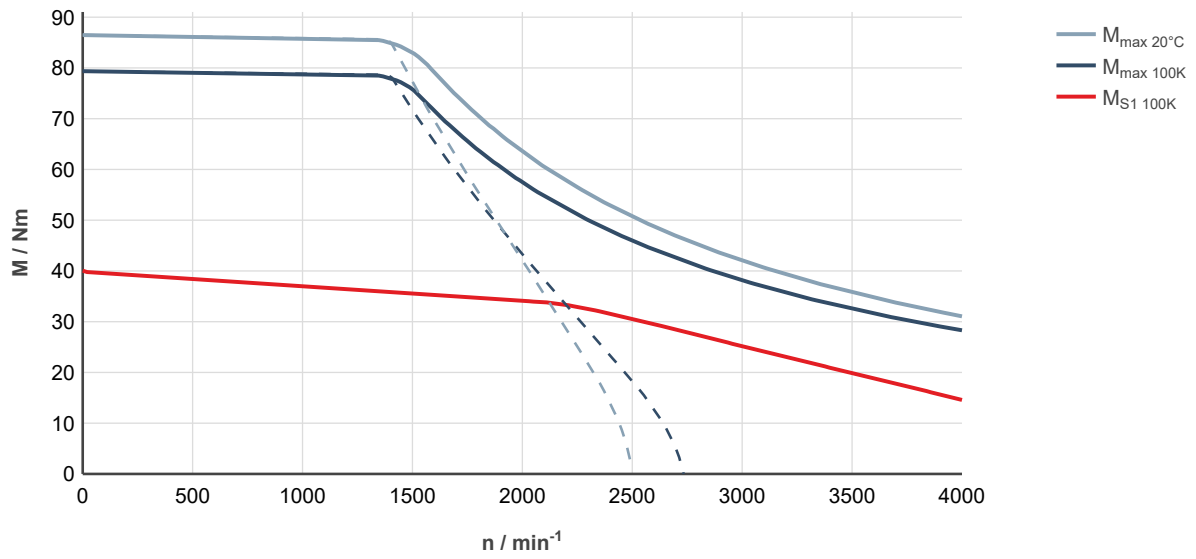

Fig. 232: MS2N10-C1BHA-___0-___-_, ctrIX DRIVE, uncontrolled supply 3 x AC 400 V

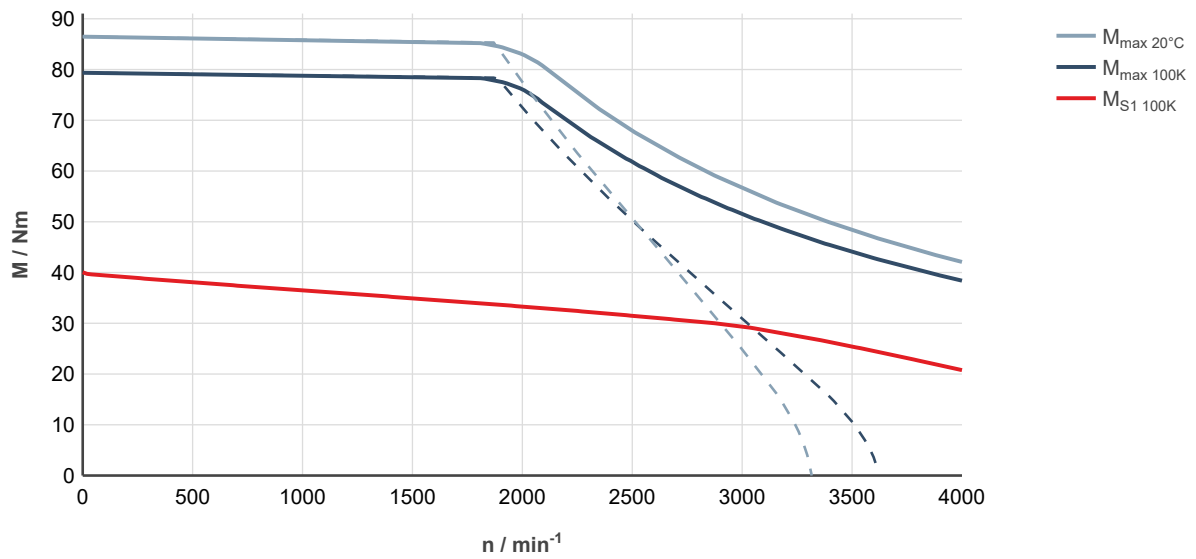

Fig. 233: MS2N10-C1BHA-___0-___-_, ctrIX DRIVE, controlled supply 3 x AC 400 ... 480 V

MS2N10-C1BNA/B

Designation	Symbol	Unit	MS2N10- C1BNA-__0- _N	MS2N10- C1BNA-__2- _N	MS2N10- C1BNB-__0- _N	MS2N10- C1BNB-__2- _N
Standstill torque - 100K ¹⁾	M _{0 100K}	Nm	40.0			
Standstill current - 100K	I _{0 100K}	A	24.7			
Moment of inertia of rotor ¹⁾	J _{rot}	kg*m ²	0.0092	0.01067	0.0092	0.01067
Rated speed - 100K	n _{N 100K}	1/min	3000			
Rated torque - 100K ¹⁾	M _{N 100K}	Nm	25.8			
Rated current - 100K	I _{N 100K}	A	16.3			
Rated power - 100K ¹⁾	P _{N 100K}	kW	8.1			
Maximum torque 20 °C (cold) ¹⁾	M _{max 20°C}	Nm	86.5			
Maximum torque 100K (warm) ¹⁾	M _{max 100K}	Nm	79.4			
Maximum current	I _{max(rms)}	A	60.8			
Maximum speed (electrical)	n _{max el}	1/min	6000			
Maximum speed (mechanical)	n _{max mech}	1/min	6000			
Number of pole pairs	p		5			
Torque constant at 20 °C ¹⁾	K _m	Nm/A	1.78			
Voltage constant at 20 °C ¹⁾	K _E	V/1000 min ⁻¹	107.9			
Winding resistance at 20 °C	R ₁₂	Ohm	0.439			
Winding inductance	L _{12_min}	mH	6.6			
Leakage capacitance of the component	C _{ab}	nF	1.52			
Thermal time constant of winding	T _{th_W}	s	68.5			
Thermal time constant of motor	T _{th_M}	min	10.4			
Mass	m _{mot}	kg	25	30	25	30
Holding brake						
Holding torque	M ₄	Nm	0	53.00	0	53.00
Rated voltage	U _N	V	0	24	0	24
Rated current	I _N	A	0	1.00	0	1.00
Maximum connection time	t ₁	ms	0	70	0	70
Maximum disconnection time	t ₂	ms	0	220	0	220
Fan data						
Rated voltage	U _N	V	230		115	
Rated current	I _N	A	0.26/0.23		0.46	
Frequency	f _N	Hz	50/60		60	
1) For tolerance details refer to chapter 6.4 Tolerances			Latest amendment: 2019-07-02			

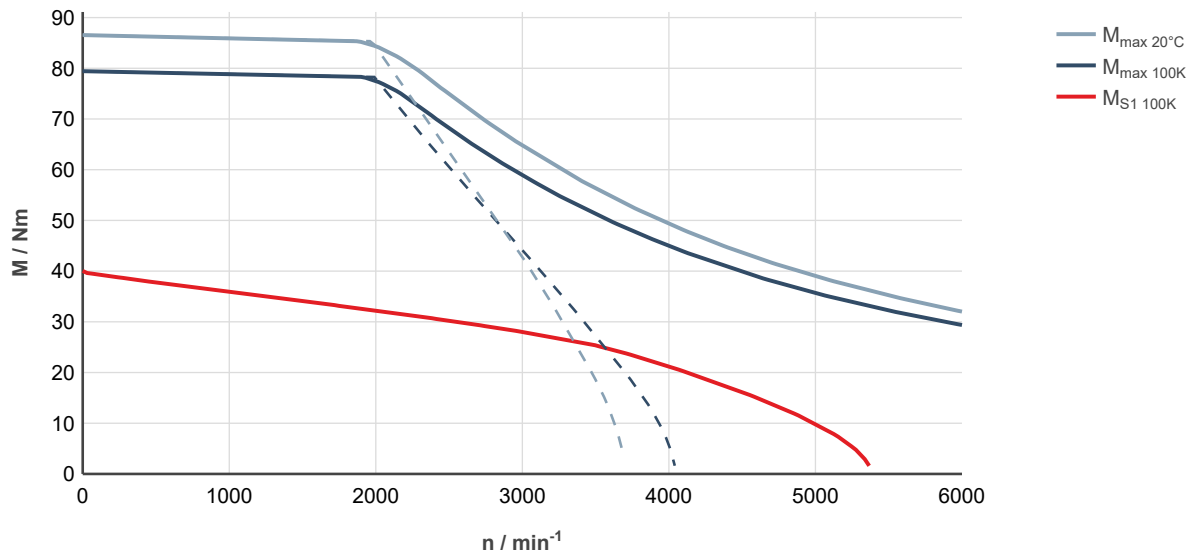

Fig. 234: MS2N10-C1BNA-___0-___-_, ctrlX DRIVE, uncontrolled supply 3 × AC 400 V

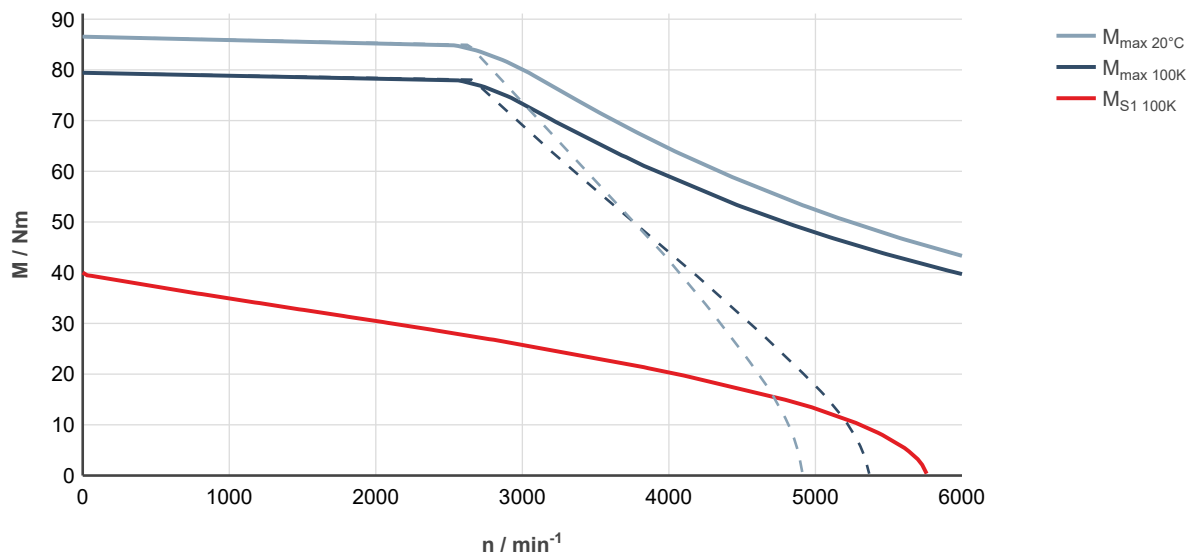

Fig. 235: MS2N10-C1BNA-___0-___-_, ctrlX DRIVE, controlled supply 3 × AC 400 ... 480 V

MS2N10-D0BHA/B

Designation	Symbol	Unit	MS2N10- D0BHA-__0- _N	MS2N10- D0BHA-__2- _N	MS2N10- D0BHB-__0- _N	MS2N10- D0BHB-__2- _N
Standstill torque - 100K ¹⁾	M _{0 100K}	Nm	82.4			
Standstill current - 100K	I _{0 100K}	A	32.4			
Moment of inertia of rotor ¹⁾	J _{rot}	kg*m ²	0.0081	0.00957	0.0081	0.00957
Rated speed - 100K	n _{N 100K}	1/min	1800			
Rated torque - 100K ¹⁾	M _{N 100K}	Nm	67.4			
Rated current - 100K	I _{N 100K}	A	26.6			
Rated power - 100K ¹⁾	P _{N 100K}	kW	12.7			
Maximum torque 20 °C (cold) ¹⁾	M _{max 20°C}	Nm	155			
Maximum torque 100K (warm) ¹⁾	M _{max 100K}	Nm	142			
Maximum current	I _{max(rms)}	A	70			
Maximum speed (electrical)	n _{max el}	1/min	4000			
Maximum speed (mechanical)	n _{max mech}	1/min	6000			
Number of pole pairs	p		5			
Torque constant at 20 °C ¹⁾	K _m	Nm/A	2.86			
Voltage constant at 20 °C ¹⁾	K _E	V/1000 min ⁻¹	173.5			
Winding resistance at 20 °C	R ₁₂	Ohm	0.386			
Winding inductance	L _{12_min}	mH	10.3			
Leakage capacitance of the component	C _{ab}	nF	3.15			
Thermal time constant of winding	T _{th_W}	s	90.0			
Thermal time constant of motor	T _{th_M}	min	11.6			
Mass	m _{mot}	kg	35	40	35	40
Holding brake						
Holding torque	M ₄	Nm	0	53.00	0	53.00
Rated voltage	U _N	V	0	24	0	24
Rated current	I _N	A	0	1.00	0	1.00
Maximum connection time	t ₁	ms	0	70	0	70
Maximum disconnection time	t ₂	ms	0	220	0	220
Fan data						
Rated voltage	U _N	V	230		115	
Rated current	I _N	A	0.26/0.23		0.46	
Frequency	f _N	Hz	50/60		60	
1) For tolerance details refer to chapter 6.4 Tolerances			Latest amendment: 2019-07-02			

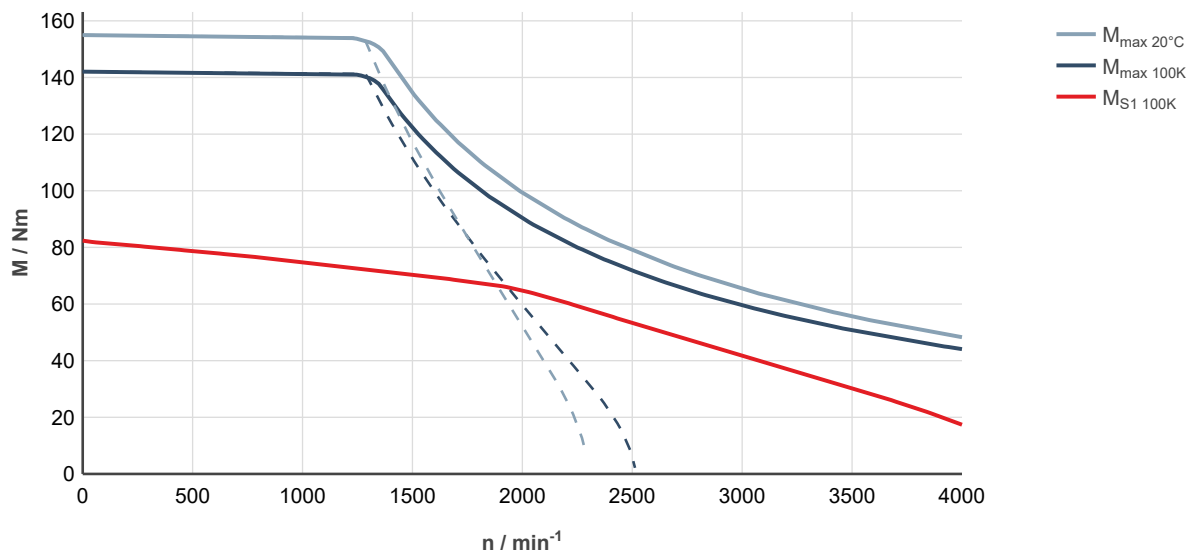

Fig. 236: MS2N10-D0BHA-___0-___-_, ctrlX DRIVE, uncontrolled supply 3 × AC 400 V

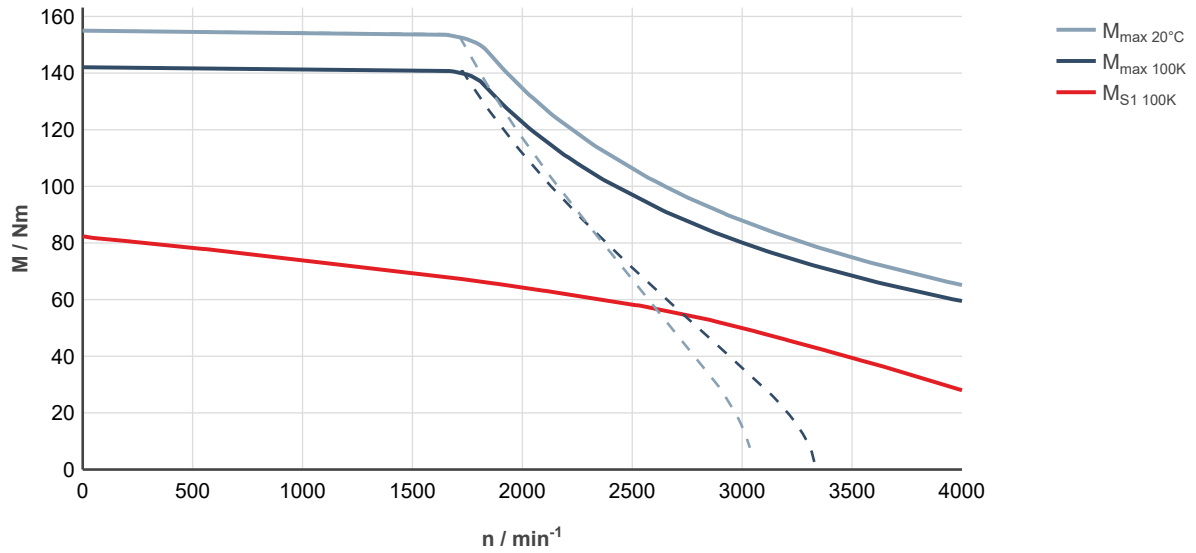

Fig. 237: MS2N10-D0BHA-___0-___-_, ctrlX DRIVE, controlled supply 3 × AC 400 ... 480 V

MS2N10-D0BNA/B

Designation	Symbol	Unit	MS2N10- D0BNA-__0- _N	MS2N10- D0BNA-__2- _N	MS2N10- D0BNB-__0- _N	MS2N10- D0BNB-__2- _N
Standstill torque - 100K ¹⁾	M _{0 100K}	Nm	82.4			
Standstill current - 100K	I _{0 100K}	A	48			
Moment of inertia of rotor ¹⁾	J _{rot}	kg*m ²	0.0081	0.00957	0.0081	0.00957
Rated speed - 100K	n _{N 100K}	1/min	2870			
Rated torque - 100K ¹⁾	M _{N 100K}	Nm	48.7			
Rated current - 100K	I _{N 100K}	A	28.5			
Rated power - 100K ¹⁾	P _{N 100K}	kW	14.65			
Maximum torque 20 °C (cold) ¹⁾	M _{max 20°C}	Nm	155			
Maximum torque 100K (warm) ¹⁾	M _{max 100K}	Nm	142			
Maximum current	I _{max(rms)}	A	102.5			
Maximum speed (electrical)	n _{max el}	1/min	6000			
Maximum speed (mechanical)	n _{max mech}	1/min	6000			
Number of pole pairs	p		5			
Torque constant at 20 °C ¹⁾	K _m	Nm/A	1.95			
Voltage constant at 20 °C ¹⁾	K _E	V/1000 min ⁻¹	118.5			
Winding resistance at 20 °C	R ₁₂	Ohm	0.18			
Winding inductance	L _{12_min}	mH	5.05			
Leakage capacitance of the component	C _{ab}	nF	4.1			
Thermal time constant of winding	T _{th_W}	s	90.0			
Thermal time constant of motor	T _{th_M}	min	11.6			
Mass	m _{mot}	kg	35	40	35	40
Holding brake						
Holding torque	M ₄	Nm	0	53.00	0	53.00
Rated voltage	U _N	V	0	24	0	24
Rated current	I _N	A	0	1.00	0	1.00
Maximum connection time	t ₁	ms	0	70	0	70
Maximum disconnection time	t ₂	ms	0	220	0	220
Fan data						
Rated voltage	U _N	V	230		115	
Rated current	I _N	A	0.26/0.23		0.46	
Frequency	f _N	Hz	50/60		60	
1) For tolerance details refer to chapter 6.4 Tolerances			Latest amendment: 2019-07-02			

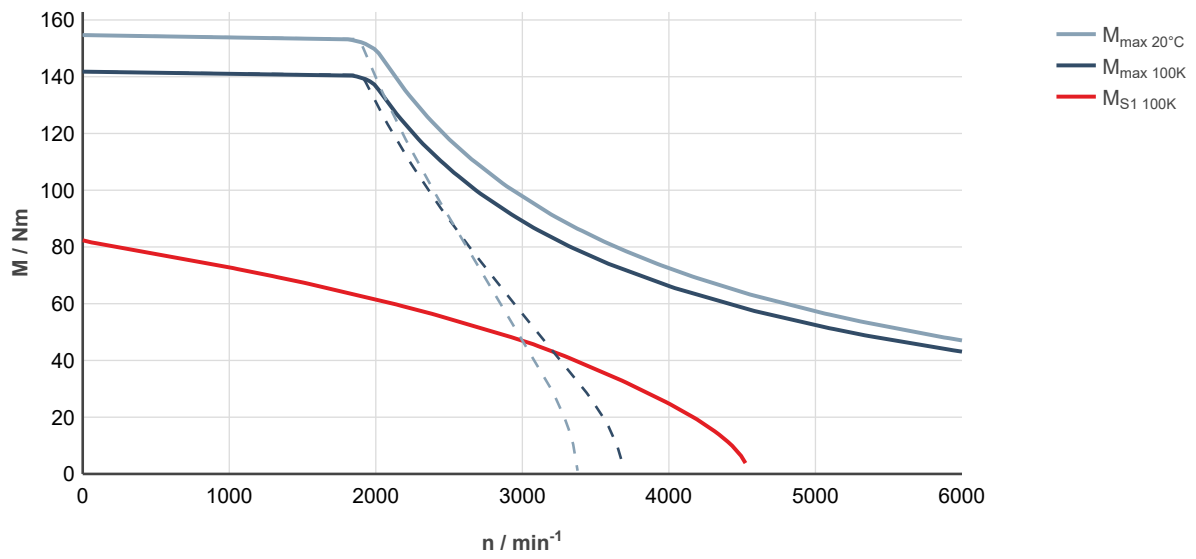

Fig. 238: MS2N10-D0BNA-___0-___-_, ctrlX DRIVE, uncontrolled supply 3 × AC 400 V

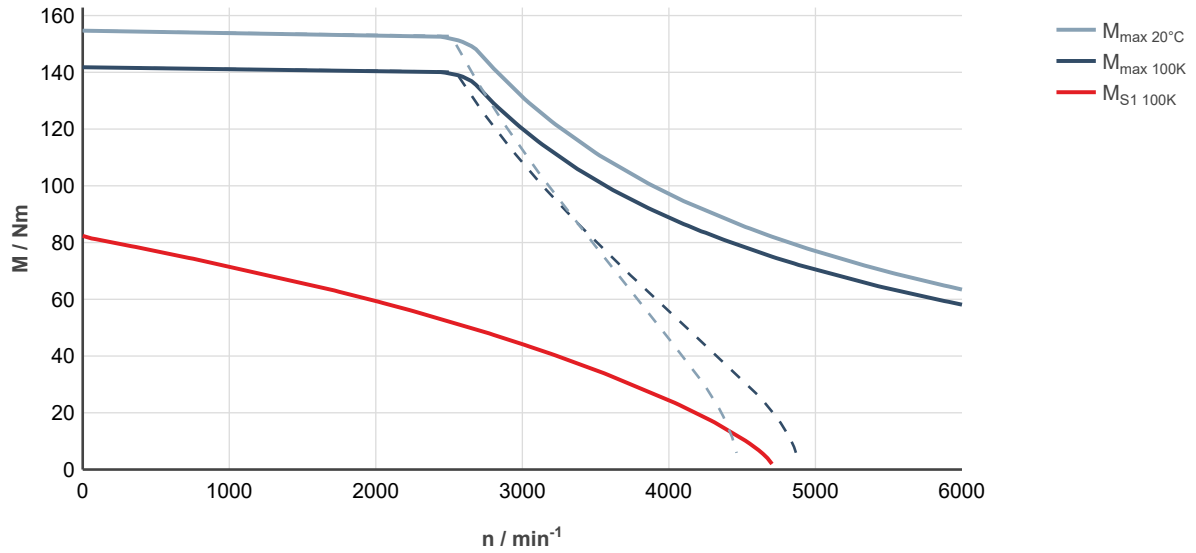

Fig. 239: MS2N10-D0BNA-___0-___-_, ctrlX DRIVE, controlled supply 3 × AC 400 ... 480 V

MS2N10-D1BFA/B

Designation	Symbol	Unit	MS2N10- D1BFA-__0- _N	MS2N10- D1BFA-__2- _N	MS2N10- D1BFB-__0- _N	MS2N10- D1BFB-__2- _N
Standstill torque - 100K ¹⁾	M _{0 100K}	Nm	78.0			
Standstill current - 100K	I _{0 100K}	A	24.2			
Moment of inertia of rotor ¹⁾	J _{rot}	kg*m ²	0.0171	0.01857	0.0171	0.01857
Rated speed - 100K	n _{N 100K}	1/min	1500			
Rated torque - 100K ¹⁾	M _{N 100K}	Nm	66.1			
Rated current - 100K	I _{N 100K}	A	20.8			
Rated power - 100K ¹⁾	P _{N 100K}	kW	10.4			
Maximum torque 20 °C (cold) ¹⁾	M _{max 20°C}	Nm	174			
Maximum torque 100K (warm) ¹⁾	M _{max 100K}	Nm	160			
Maximum current	I _{max(rms)}	A	60.7			
Maximum speed (electrical)	n _{max el}	1/min	3000			
Maximum speed (mechanical)	n _{max mech}	1/min	6000			
Number of pole pairs	p		5			
Torque constant at 20 °C ¹⁾	K _m	Nm/A	3.53			
Voltage constant at 20 °C ¹⁾	K _E	V/1000 min ⁻¹	214.5			
Winding resistance at 20 °C	R ₁₂	Ohm	0.70			
Winding inductance	L _{12_min}	mH	12.2			
Leakage capacitance of the component	C _{ab}	nF	3.3			
Thermal time constant of winding	T _{th_W}	s	74.2			
Thermal time constant of motor	T _{th_M}	min	11.6			
Mass	m _{mot}	kg	37	42	37	42
Holding brake						
Holding torque	M ₄	Nm	0	53.00	0	53.00
Rated voltage	U _N	V	0	24	0	24
Rated current	I _N	A	0	1.00	0	1.00
Maximum connection time	t ₁	ms	0	70	0	70
Maximum disconnection time	t ₂	ms	0	220	0	220
Fan data						
Rated voltage	U _N	V	230		115	
Rated current	I _N	A	0.26/0.23		0.46	
Frequency	f _N	Hz	50/60		60	
1) For tolerance details refer to chapter 6.4 Tolerances			Latest amendment: 2019-07-02			

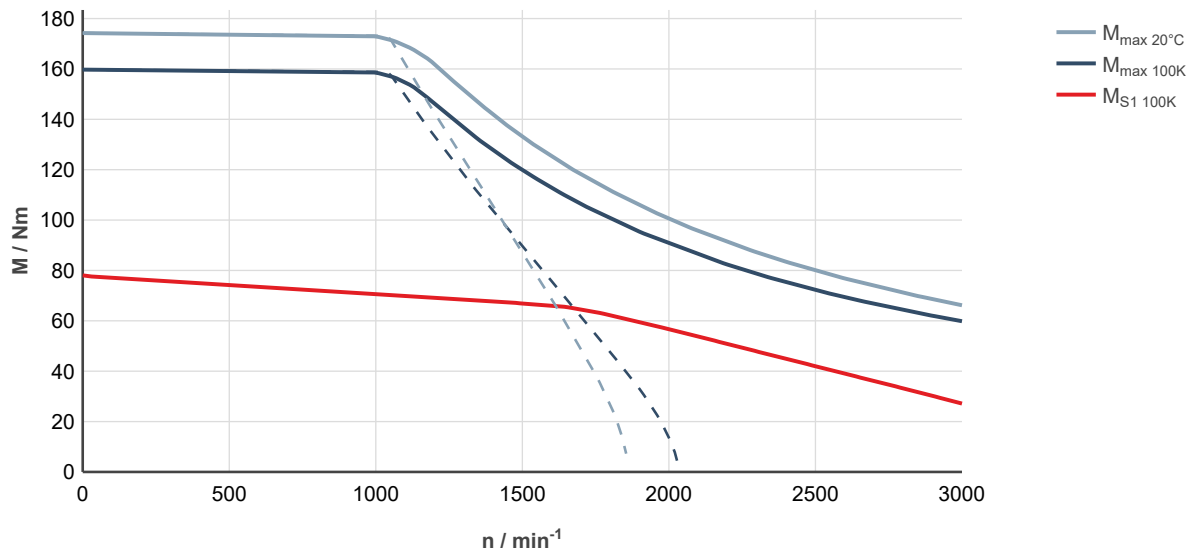

Fig. 240: MS2N10-D1BFA-___0-___-__, ctrlX DRIVE, uncontrolled supply 3 × AC 400 V

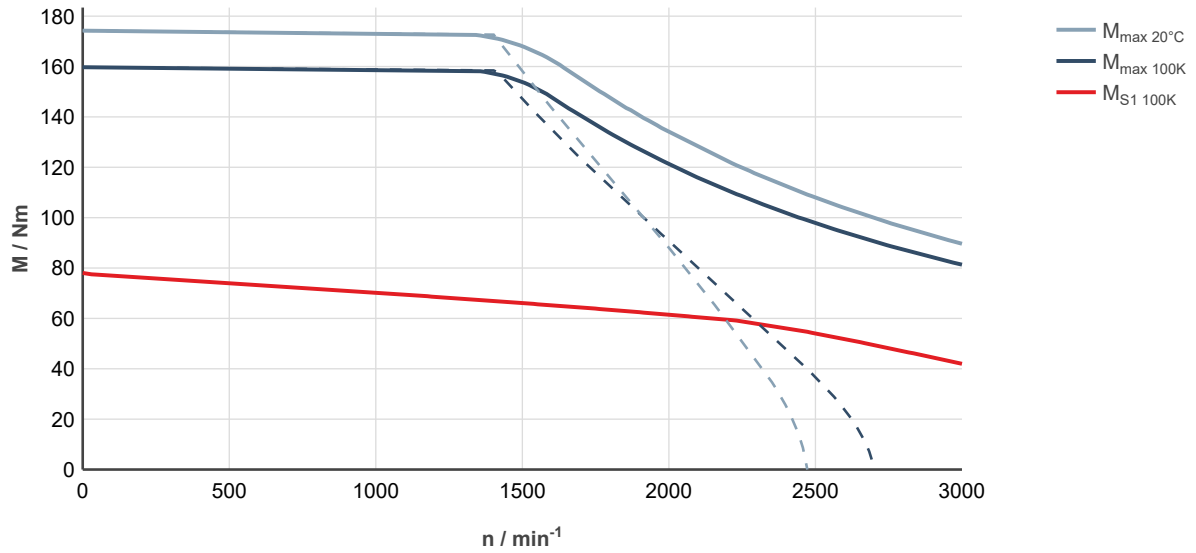

Fig. 241: MS2N10-D1BFA-___0-___-__, ctrlX DRIVE, controlled supply 3 × AC 400 ... 480 V

MS2N10-D1BNA/B

Designation	Symbol	Unit	MS2N10- D1BNA-__0- _N	MS2N10- D1BNA-__2- _N	MS2N10- D1BNB-__0- _N	MS2N10- D1BNB-__2- _N
Standstill torque - 100K ¹⁾	M _{0 100K}	Nm	78.0			
Standstill current - 100K	I _{0 100K}	A	48.5			
Moment of inertia of rotor ¹⁾	J _{rot}	kg*m ²	0.0171	0.01857	0.0171	0.01857
Rated speed - 100K	n _{N 100K}	1/min	3000			
Rated torque - 100K ¹⁾	M _{N 100K}	Nm	42.1			
Rated current - 100K	I _{N 100K}	A	27.0			
Rated power - 100K ¹⁾	P _{N 100K}	kW	13.2			
Maximum torque 20 °C (cold) ¹⁾	M _{max 20°C}	Nm	174			
Maximum torque 100K (warm) ¹⁾	M _{max 100K}	Nm	160			
Maximum current	I _{max(rms)}	A	121.5			
Maximum speed (electrical)	n _{max el}	1/min	6000			
Maximum speed (mechanical)	n _{max mech}	1/min	6000			
Number of pole pairs	p		5			
Torque constant at 20 °C ¹⁾	K _m	Nm/A	1.76			
Voltage constant at 20 °C ¹⁾	K _E	V/1000 min ⁻¹	107.6			
Winding resistance at 20 °C	R ₁₂	Ohm	0.178			
Winding inductance	L _{12_min}	mH	3.23			
Leakage capacitance of the component	C _{ab}	nF	3.33			
Thermal time constant of winding	T _{th_W}	s	74.2			
Thermal time constant of motor	T _{th_M}	min	11.6			
Mass	m _{mot}	kg	37	42	37	42
Holding brake						
Holding torque	M ₄	Nm	0	53.00	0	53.00
Rated voltage	U _N	V	0	24	0	24
Rated current	I _N	A	0	1.00	0	1.00
Maximum connection time	t ₁	ms	0	70	0	70
Maximum disconnection time	t ₂	ms	0	220	0	220
Fan data						
Rated voltage	U _N	V	230		115	
Rated current	I _N	A	0.26/0.23		0.46	
Frequency	f _N	Hz	50/60		60	
1) For tolerance details refer to chapter 6.4 Tolerances			Latest amendment: 2019-07-02			

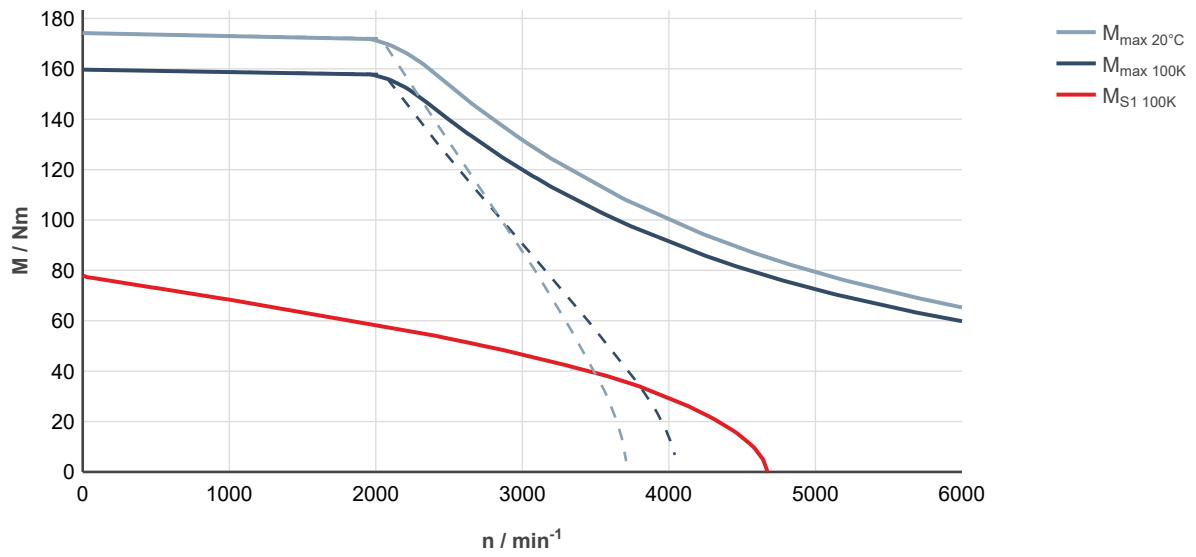

Fig. 242: MS2N10-D1BNA-___0-___-_, ctrlX DRIVE, uncontrolled supply 3 × AC 400 V

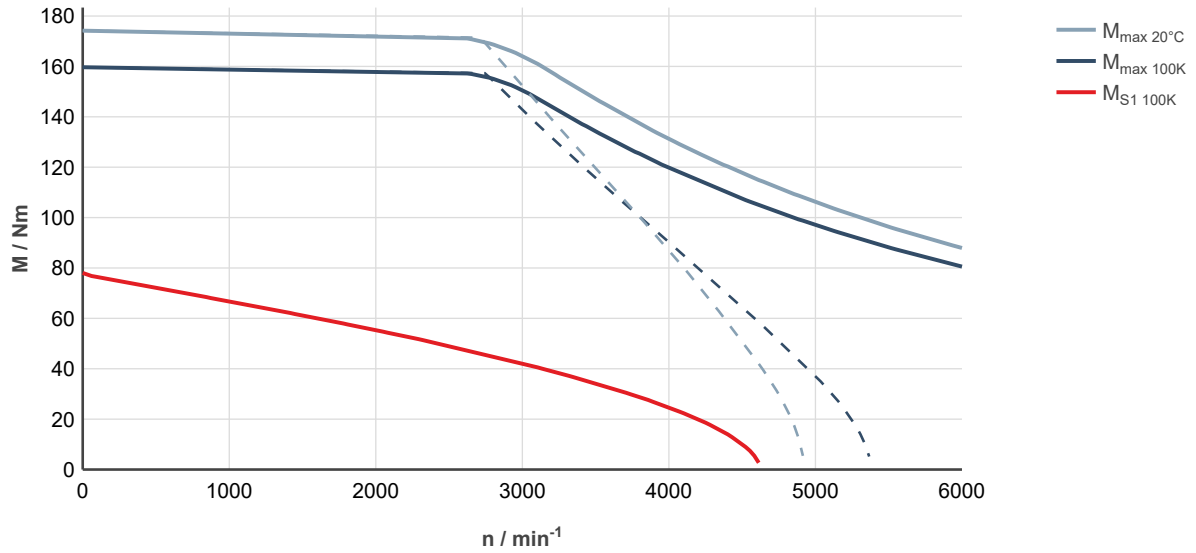

Fig. 243: MS2N10-D1BNA-___0-___-_, ctrlX DRIVE, controlled supply 3 × AC 400 ... 480 V

MS2N10-E0BHA/B

Designation	Symbol	Unit	MS2N10- E0BHA-__0- _N	MS2N10- E0BHA-__3- _N	MS2N10- E0BHB-__0- _N	MS2N10- E0BHB-__3- _N
Standstill torque - 100K ¹⁾	M _{0 100K}	Nm	119			
Standstill current - 100K	I _{0 100K}	A	46.1			
Moment of inertia of rotor ¹⁾	J _{rot}	kg*m ²	0.0114	0.0141	0.0114	0.0141
Rated speed - 100K	n _{N 100K}	1/min	1800			
Rated torque - 100K ¹⁾	M _{N 100K}	Nm	96			
Rated current - 100K	I _{N 100K}	A	37.4			
Rated power - 100K ¹⁾	P _{N 100K}	kW	18.1			
Maximum torque 20 °C (cold) ¹⁾	M _{max 20°C}	Nm	234			
Maximum torque 100K (warm) ¹⁾	M _{max 100K}	Nm	214			
Maximum current	I _{max(rms)}	A	102.5			
Maximum speed (electrical)	n _{max el}	1/min	4000			
Maximum speed (mechanical)	n _{max mech}	1/min	6000			
Number of pole pairs	p		5			
Torque constant at 20 °C ¹⁾	K _m	Nm/A	2.9			
Voltage constant at 20 °C ¹⁾	K _E	V/1000 min ⁻¹	176.4			
Winding resistance at 20 °C	R ₁₂	Ohm	0.244			
Winding inductance	L _{12_min}	mH	7.43			
Leakage capacitance of the component	C _{ab}	nF	6.2			
Thermal time constant of winding	T _{th_W}	s	97.5			
Thermal time constant of motor	T _{th_M}	min	12.5			
Mass	m _{mot}	kg	46	53	46	53
Holding brake						
Holding torque	M ₄	Nm	0	90.00	0	90.00
Rated voltage	U _N	V	0	24	0	24
Rated current	I _N	A	0	1.50	0	1.50
Maximum connection time	t ₁	ms	0	65	0	65
Maximum disconnection time	t ₂	ms	0	250	0	250
Fan data						
Rated voltage	U _N	V	230		115	
Rated current	I _N	A	0.26/0.23		0.46	
Frequency	f _N	Hz	50/60		60	
1) For tolerance details refer to chapter 6.4 Tolerances			Latest amendment: 2019-07-02			

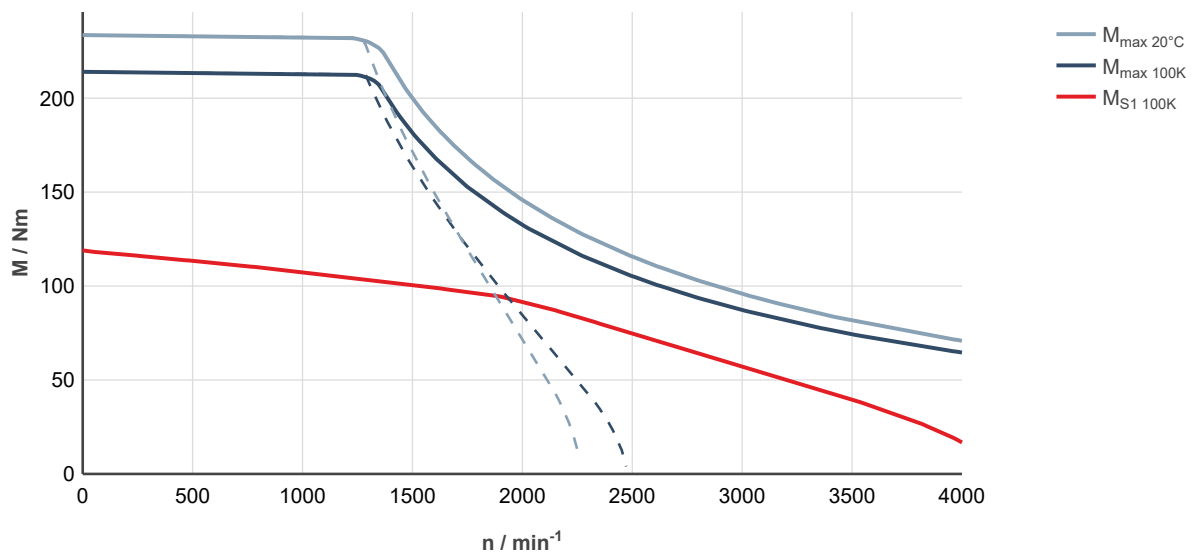

Fig. 244: MS2N10-E0BHA-___0-___-_, ctrlX DRIVE, uncontrolled supply 3 × AC 400 V

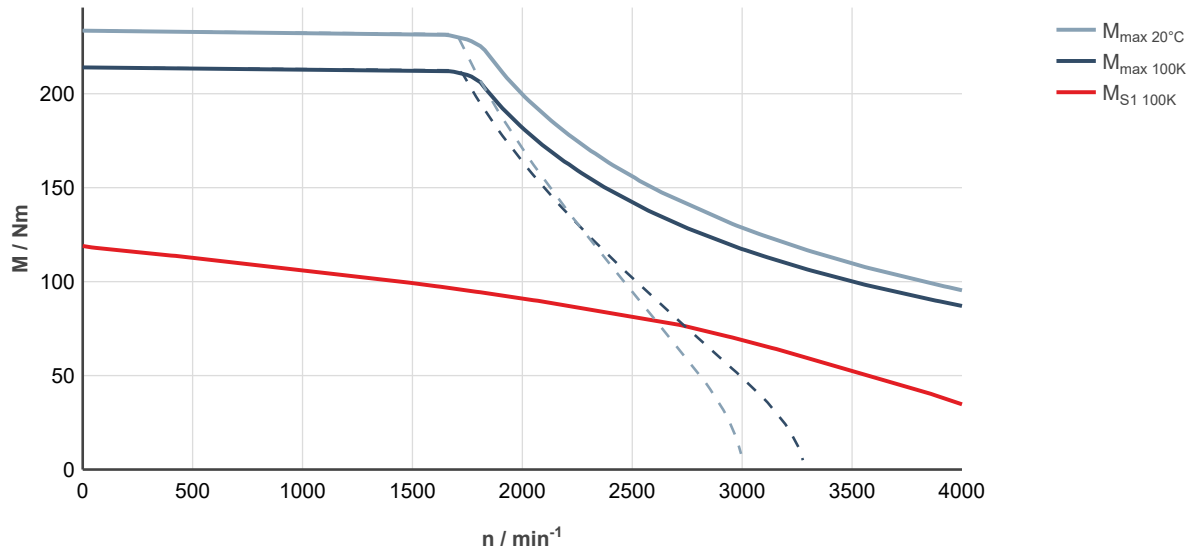

Fig. 245: MS2N10-E0BHA-___0-___-_, ctrlX DRIVE, controlled supply 3 × AC 400 ... 480 V

MS2N10-E0BNA/B

Designation	Symbol	Unit	MS2N10- E0BNA-__0- _N			
			MS2N10- E0BNA-__3- _N	MS2N10- E0BNA-__3- _N	MS2N10- E0BNA-__0- _N	MS2N10- E0BNA-__3- _N
Standstill torque - 100K ¹⁾	M _{0 100K}	Nm	119			
Standstill current - 100K	I _{0 100K}	A	62.9			
Moment of inertia of rotor ¹⁾	J _{rot}	kg*m ²	0.0114	0.0141	0.0114	0.0141
Rated speed - 100K	n _{N 100K}	1/min	2660			
Rated torque - 100K ¹⁾	M _{N 100K}	Nm	69.9			
Rated current - 100K	I _{N 100K}	A	37.4			
Rated power - 100K ¹⁾	P _{N 100K}	kW	19.5			
Maximum torque 20 °C (cold) ¹⁾	M _{max 20°C}	Nm	234			
Maximum torque 100K (warm) ¹⁾	M _{max 100K}	Nm	214			
Maximum current	I _{max(rms)}	A	140			
Maximum speed (electrical)	n _{max el}	1/min	6000			
Maximum speed (mechanical)	n _{max mech}	1/min	6000			
Number of pole pairs	p		5			
Torque constant at 20 °C ¹⁾	K _m	Nm/A	2.1			
Voltage constant at 20 °C ¹⁾	K _E	V/1000 min ⁻¹	128.5			
Winding resistance at 20 °C	R ₁₂	Ohm	0.133			
Winding inductance	L _{12_min}	mH	4.00			
Leakage capacitance of the component	C _{ab}	nF	6.2			
Thermal time constant of winding	T _{th_W}	s	97.5			
Thermal time constant of motor	T _{th_M}	min	12.5			
Mass	m _{mot}	kg	46	53	46	53
Holding brake						
Holding torque	M ₄	Nm	0	90.00	0	90.00
Rated voltage	U _N	V	0	24	0	24
Rated current	I _N	A	0	1.50	0	1.50
Maximum connection time	t ₁	ms	0	65	0	65
Maximum disconnection time	t ₂	ms	0	250	0	250
Fan data						
Rated voltage	U _N	V	230		115	
Rated current	I _N	A	0.26/0.23		0.46	
Frequency	f _N	Hz	50/60		60	
1) For tolerance details refer to chapter 6.4 Tolerances			Latest amendment: 2020-06-03			

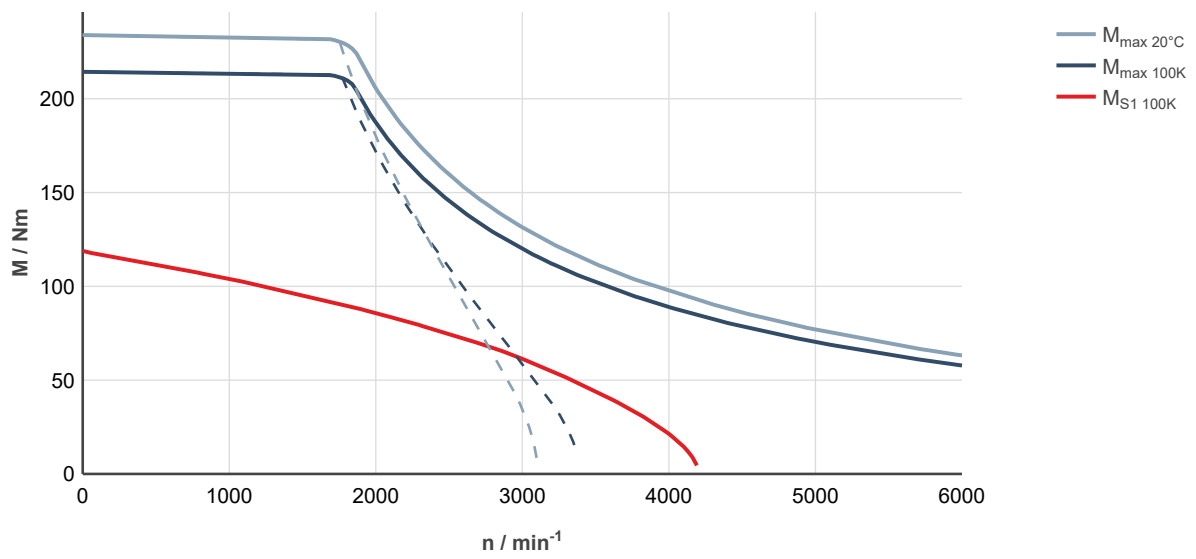

Fig. 246: MS2N10-E0BNA-___0-___-__, ctrlX DRIVE, uncontrolled supply 3 × AC 400 V

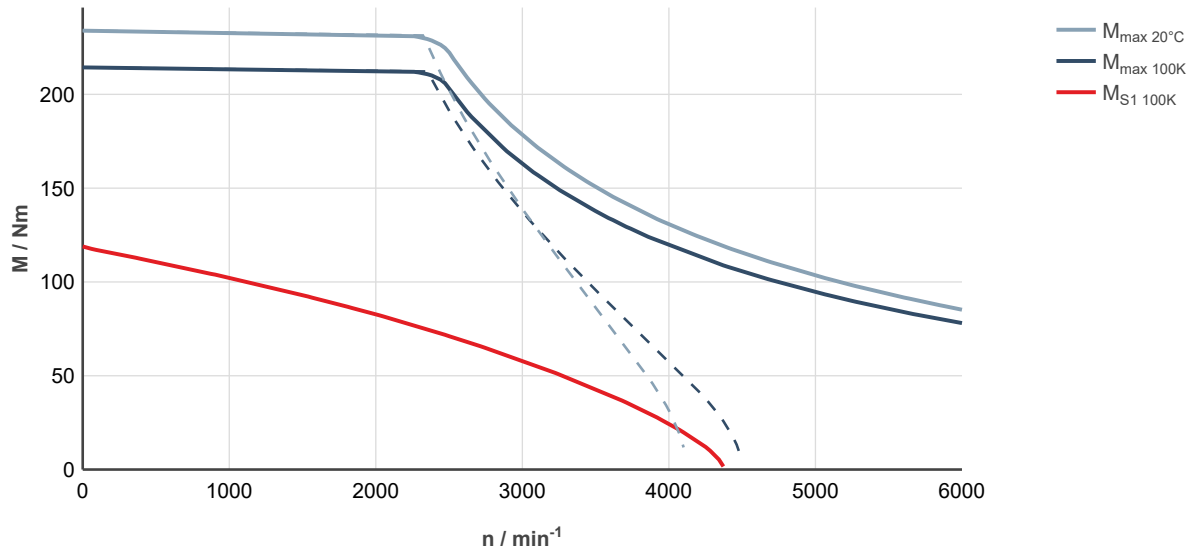

Fig. 247: MS2N10-E0BNA-___0-___-__, ctrlX DRIVE, controlled supply 3 × AC 400 ... 480 V

MS2N10-E1BFA/B

Designation	Symbol	Unit	MS2N10- E1BFA-__0- _N	MS2N10- E1BFA-__3- _N	MS2N10- E1BFB-__0- _N	MS2N10- E1BFB-__3- _N
Standstill torque - 100K ¹⁾	M _{0 100K}	Nm	113.0			
Standstill current - 100K	I _{0 100K}	A	30.8			
Moment of inertia of rotor ¹⁾	J _{rot}	kg*m ²	0.025	0.0277	0.025	0.0277
Rated speed - 100K	n _{N 100K}	1/min	1350			
Rated torque - 100K ¹⁾	M _{N 100K}	Nm	96.9			
Rated current - 100K	I _{N 100K}	A	26.8			
Rated power - 100K ¹⁾	P _{N 100K}	kW	13.7			
Maximum torque 20 °C (cold) ¹⁾	M _{max 20°C}	Nm	266			
Maximum torque 100K (warm) ¹⁾	M _{max 100K}	Nm	244			
Maximum current	I _{max(rms)}	A	81			
Maximum speed (electrical)	n _{max el}	1/min	3000			
Maximum speed (mechanical)	n _{max mech}	1/min	6000			
Number of pole pairs	p		5			
Torque constant at 20 °C ¹⁾	K _m	Nm/A	4.0			
Voltage constant at 20 °C ¹⁾	K _E	V/1000 min ⁻¹	243			
Winding resistance at 20 °C	R ₁₂	Ohm	0.53			
Winding inductance	L _{12_min}	mH	10.0			
Leakage capacitance of the component	C _{ab}	nF	5.12			
Thermal time constant of winding	T _{th_W}	s	79.5			
Thermal time constant of motor	T _{th_M}	min	12.5			
Mass	m _{mot}	kg	48	55	48	55
Holding brake						
Holding torque	M ₄	Nm	0	90.00	0	90.00
Rated voltage	U _N	V	0	24	0	24
Rated current	I _N	A	0	1.50	0	1.50
Maximum connection time	t ₁	ms	0	65	0	65
Maximum disconnection time	t ₂	ms	0	250	0	250
Fan data						
Rated voltage	U _N	V	230		115	
Rated current	I _N	A	0.26/0.23		0.46	
Frequency	f _N	Hz	50/60		60	
1) For tolerance details refer to chapter 6.4 Tolerances			Latest amendment: 2019-07-02			

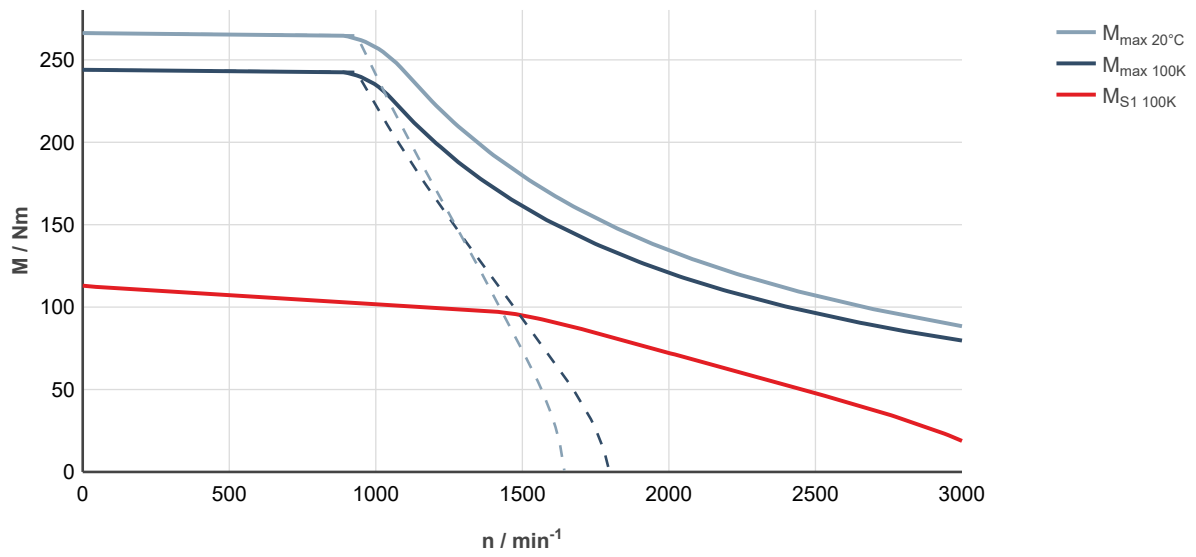

Fig. 248: MS2N10-E1BFA-___0-___-__, ctrlX DRIVE, uncontrolled supply 3 × AC 400 V

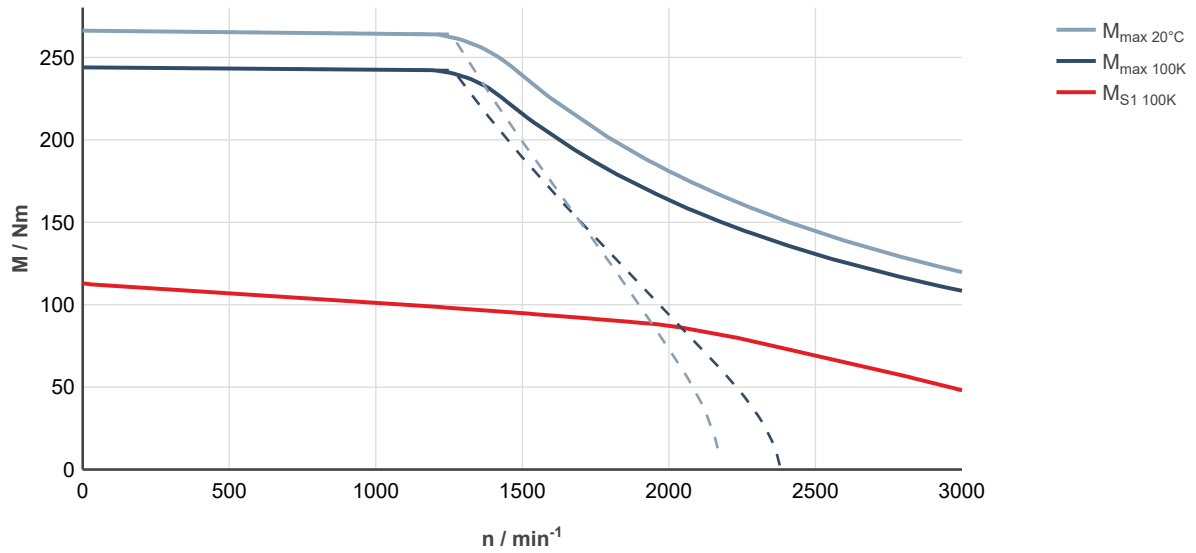

Fig. 249: MS2N10-E1BFA-___0-___-__, ctrlX DRIVE, controlled supply 3 × AC 400 ... 480 V

MS2N10-E1BNA/B

Designation	Symbol	Unit	MS2N10- E1BNA-__0- _N			
			MS2N10- E1BNA-__3- _N	MS2N10- E1BNA-__3- _N	MS2N10- E1BNB-__0- _N	MS2N10- E1BNB-__3- _N
Standstill torque - 100K ¹⁾	M _{0 100K}	Nm	113			
Standstill current - 100K	I _{0 100K}	A	61.7			
Moment of inertia of rotor ¹⁾	J _{rot}	kg*m ²	0.025	0.0277	0.025	0.0277
Rated speed - 100K	n _{N 100K}	1/min	2950			
Rated torque - 100K ¹⁾	M _{N 100K}	Nm	59.7			
Rated current - 100K	I _{N 100K}	A	33.9			
Rated power - 100K ¹⁾	P _{N 100K}	kW	18.5			
Maximum torque 20 °C (cold) ¹⁾	M _{max 20°C}	Nm	266			
Maximum torque 100K (warm) ¹⁾	M _{max 100K}	Nm	244			
Maximum current	I _{max(rms)}	A	162			
Maximum speed (electrical)	n _{max el}	1/min	6000			
Maximum speed (mechanical)	n _{max mech}	1/min	6000			
Number of pole pairs	p		5			
Torque constant at 20 °C ¹⁾	K _m	Nm/A	2.0			
Voltage constant at 20 °C ¹⁾	K _E	V/1000 min ⁻¹	121.6			
Winding resistance at 20 °C	R ₁₂	Ohm	0.137			
Winding inductance	L _{12_min}	mH	2.87			
Leakage capacitance of the component	C _{ab}	nF	5.0			
Thermal time constant of winding	T _{th_W}	s	79.5			
Thermal time constant of motor	T _{th_M}	min	12.5			
Mass	m _{mot}	kg	48	55	48	55
Holding brake						
Holding torque	M ₄	Nm	0	90.00	0	90.00
Rated voltage	U _N	V	0	24	0	24
Rated current	I _N	A	0	1.50	0	1.50
Maximum connection time	t ₁	ms	0	65	0	65
Maximum disconnection time	t ₂	ms	0	250	0	250
Fan data						
Rated voltage	U _N	V	230		115	
Rated current	I _N	A	0.26/0.23		0.46	
Frequency	f _N	Hz	50/60		60	
1) For tolerance details refer to chapter 6.4 Tolerances			Latest amendment: 2019-07-02			

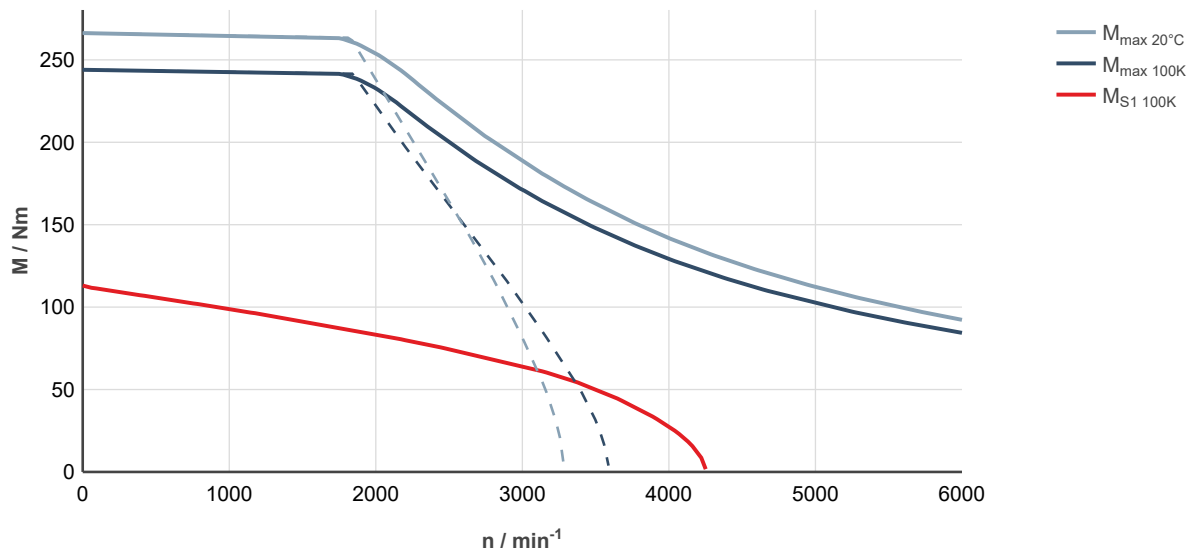

Fig. 250: MS2N10-E1BNA-___0-___-_, ctrIX DRIVE, uncontrolled supply 3 × AC 400 V

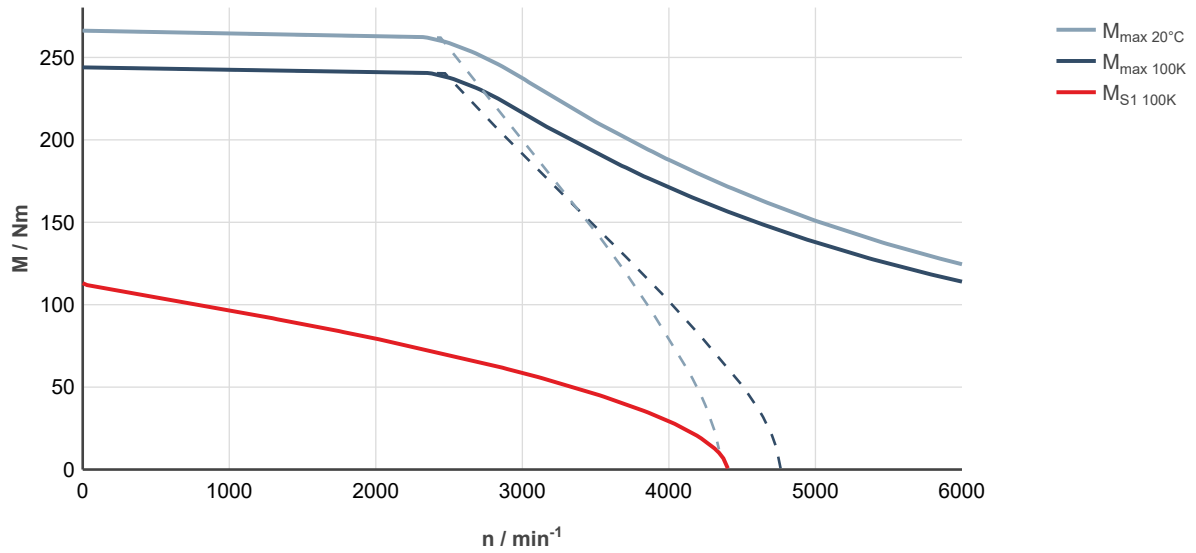

Fig. 251: MS2N10-E1BNA-___0-___-_, ctrIX DRIVE, controlled supply 3 × AC 400 ... 480 V

MS2N10-F0BDA/B

Designation	Symbol	Unit	MS2N10- F0BDA-__0- _N	MS2N10- F0BDA-__3- _N	MS2N10- F0BDB-__0- _N	MS2N10- F0BDB-__3- _N
Standstill torque - 100K ¹⁾	M _{0 100K}	Nm	148.5			
Standstill current - 100K	I _{0 100K}	A	28.8			
Moment of inertia of rotor ¹⁾	J _{rot}	kg*m ²	0.0147	0.0174	0.0147	0.0174
Rated speed - 100K	n _{N 100K}	1/min	900			
Rated torque - 100K ¹⁾	M _{N 100K}	Nm	138			
Rated current - 100K	I _{N 100K}	A	26.9			
Rated power - 100K ¹⁾	P _{N 100K}	kW	13.0			
Maximum torque 20 °C (cold) ¹⁾	M _{max 20°C}	Nm	313			
Maximum torque 100K (warm) ¹⁾	M _{max 100K}	Nm	287			
Maximum current	I _{max(rms)}	A	70			
Maximum speed (electrical)	n _{max el}	1/min	2000			
Maximum speed (mechanical)	n _{max mech}	1/min	6000			
Number of pole pairs	p		5			
Torque constant at 20 °C ¹⁾	K _m	Nm/A	5.76			
Voltage constant at 20 °C ¹⁾	K _E	V/1000 min ⁻¹	350			
Winding resistance at 20 °C	R ₁₂	Ohm	0.667			
Winding inductance	L _{12_min}	mH	20.05			
Leakage capacitance of the component	C _{ab}	nF	7.75			
Thermal time constant of winding	T _{th_W}	s	101.2			
Thermal time constant of motor	T _{th_M}	min	13.2			
Mass	m _{mot}	kg	56	63	56	63
Holding brake						
Holding torque	M ₄	Nm	0	90.00	0	90.00
Rated voltage	U _N	V	0	24	0	24
Rated current	I _N	A	0	1.50	0	1.50
Maximum connection time	t ₁	ms	0	65	0	65
Maximum disconnection time	t ₂	ms	0	250	0	250
Fan data						
Rated voltage	U _N	V	230		115	
Rated current	I _N	A	0.26/0.23		0.46	
Frequency	f _N	Hz	50/60		60	
1) For tolerance details refer to chapter 6.4 Tolerances			Latest amendment: 2019-07-02			

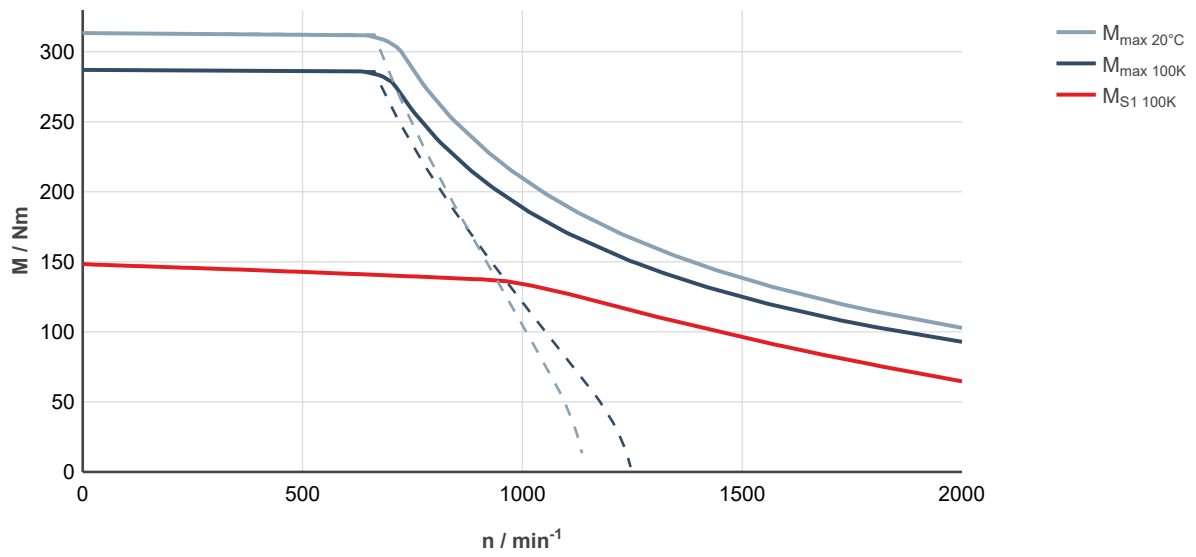

Fig. 252: MS2N10-F0BDA-___0-___-_, ctrlX DRIVE, uncontrolled supply 3 × AC 400 V

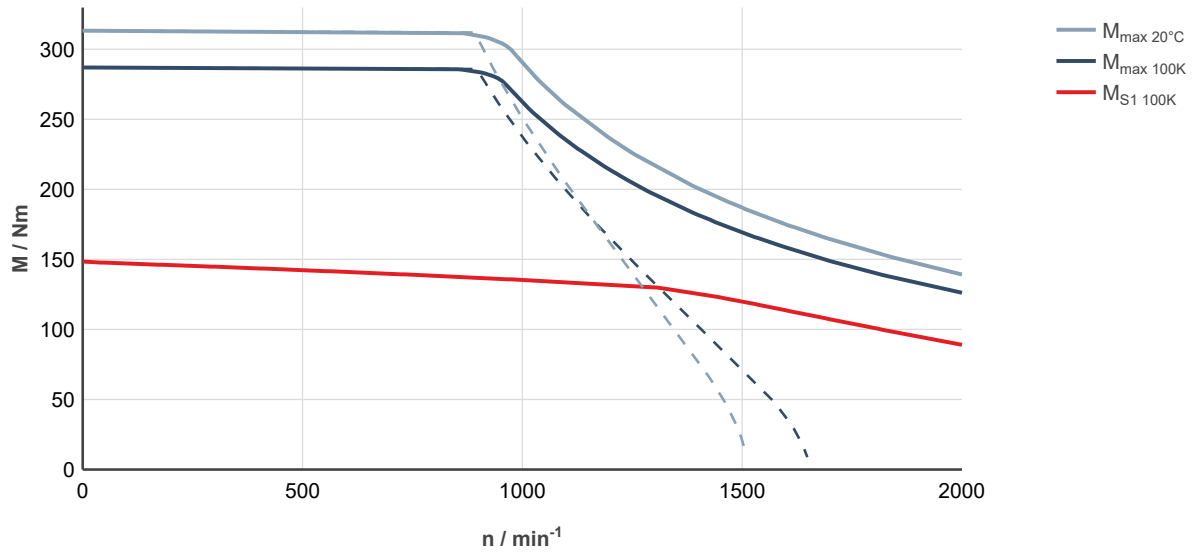

Fig. 253: MS2N10-F0BDA-___0-___-_, ctrlX DRIVE, controlled supply 3 × AC 400 ... 480 V

MS2N10-FOBHA/B

Designation	Symbol	Unit	MS2N10- FOBHA-__0- _N	MS2N10- FOBHA-__3- _N	MS2N10- FOBHB-__0- _N	MS2N10- FOBHB-__3- _N
Standstill torque - 100K ¹⁾	$M_{0\ 100K}$	Nm	148.5			
Standstill current - 100K	$I_{0\ 100K}$	A	58.6			
Moment of inertia of rotor ¹⁾	J_{rot}	kg*m ²	0.0147	0.0174	0.0147	0.0174
Rated speed - 100K	$n_{N\ 100K}$	1/min	1950			
Rated torque - 100K ¹⁾	$M_{N\ 100K}$	Nm	109.5			
Rated current - 100K	$I_{N\ 100K}$	A	43.6			
Rated power - 100K ¹⁾	$P_{N\ 100K}$	kW	22.4			
Maximum torque 20 °C (cold) ¹⁾	$M_{max\ 20°C}$	Nm	313			
Maximum torque 100K (warm) ¹⁾	$M_{max\ 100K}$	Nm	287			
Maximum current	$I_{max(rms)}$	A	140			
Maximum speed (electrical)	$n_{max\ el}$	1/min	4000			
Maximum speed (mechanical)	$n_{max\ mech}$	1/min	6000			
Number of pole pairs	p		5			
Torque constant at 20 °C ¹⁾	K_m	Nm/A	2.84			
Voltage constant at 20 °C ¹⁾	K_E	V/1000 min ⁻¹	172.5			
Winding resistance at 20 °C	R_{12}	Ohm	0.169			
Winding inductance	L_{12_min}	mH	5.01			
Leakage capacitance of the component	C_{ab}	nF	8.7			
Thermal time constant of winding	T_{th_W}	s	101.2			
Thermal time constant of motor	T_{th_M}	min	13.2			
Mass	m_{mot}	kg	56	63	56	63
Holding brake						
Holding torque	M_4	Nm	0	90.00	0	90.00
Rated voltage	U_N	V	0	24	0	24
Rated current	I_N	A	0	1.50	0	1.50
Maximum connection time	t_1	ms	0	65	0	65
Maximum disconnection time	t_2	ms	0	250	0	250
Fan data						
Rated voltage	U_N	V	230		115	
Rated current	I_N	A	0.26/0.23		0.46	
Frequency	f_N	Hz	50/60		60	
1) For tolerance details refer to chapter 6.4 Tolerances			Latest amendment: 2019-07-02			

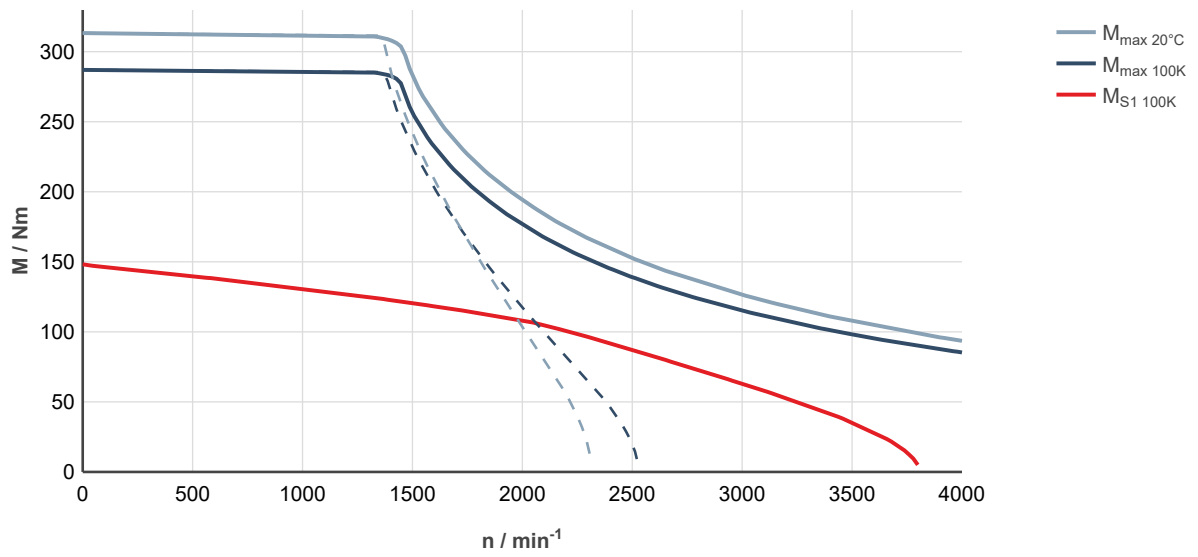

Fig. 254: MS2N10-F0BHA-___0-___-_, ctrIX DRIVE, uncontrolled supply 3 × AC 400 V

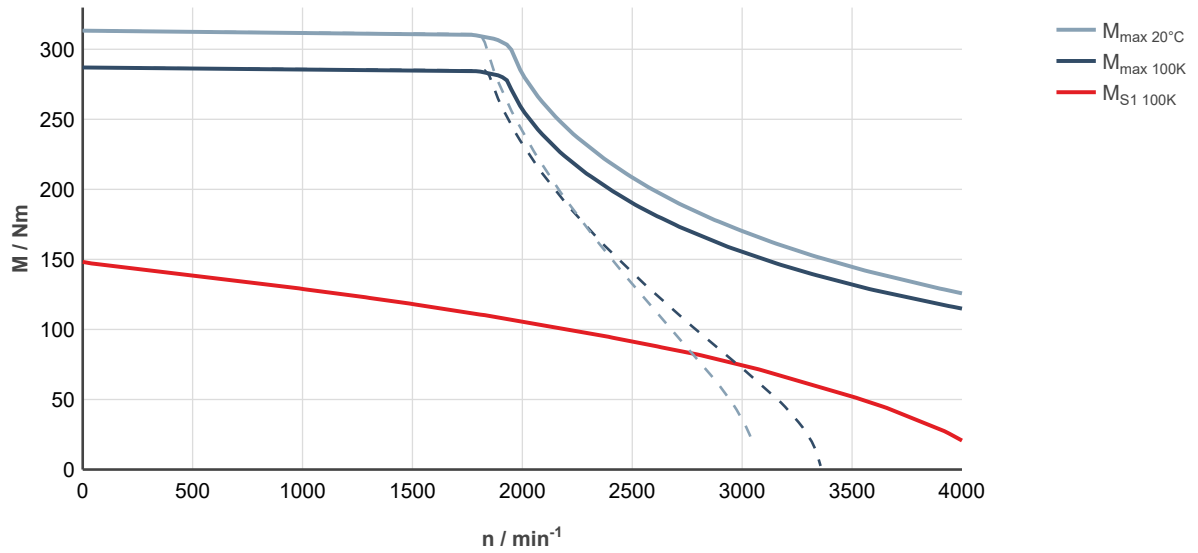

Fig. 255: MS2N10-F0BHA-___0-___-_, ctrIX DRIVE, controlled supply 3 × AC 400 ... 480 V

MS2N10-F1BDA/B

Designation	Symbol	Unit	MS2N10- F1BDA-__0- _N	MS2N10- F1BDA-__3- _N	MS2N10- F1BDB-__0- _N	MS2N10- F1BDB-__3- _N
Standstill torque - 100K ¹⁾	M _{0 100K}	Nm	145			
Standstill current - 100K	I _{0 100K}	A	29.5			
Moment of inertia of rotor ¹⁾	J _{rot}	kg*m ²	0.0329	0.0356	0.0329	0.0356
Rated speed - 100K	n _{N 100K}	1/min	1000			
Rated torque - 100K ¹⁾	M _{N 100K}	Nm	131			
Rated current - 100K	I _{N 100K}	A	26.9			
Rated power - 100K ¹⁾	P _{N 100K}	kW	13.7			
Maximum torque 20 °C (cold) ¹⁾	M _{max 20°C}	Nm	360			
Maximum torque 100K (warm) ¹⁾	M _{max 100K}	Nm	330			
Maximum current	I _{max(rms)}	A	81.0			
Maximum speed (electrical)	n _{max el}	1/min	2000			
Maximum speed (mechanical)	n _{max mech}	1/min	6000			
Number of pole pairs	p		5			
Torque constant at 20 °C ¹⁾	K _m	Nm/A	5.36			
Voltage constant at 20 °C ¹⁾	K _E	V/1000 min ⁻¹	325.5			
Winding resistance at 20 °C	R ₁₂	Ohm	0.678			
Winding inductance	L _{12_min}	mH	14.6			
Leakage capacitance of the component	C _{ab}	nF	6.8			
Thermal time constant of winding	T _{th_W}	s	83.0			
Thermal time constant of motor	T _{th_M}	min	13.2			
Mass	m _{mot}	kg	60	67	60	67
Holding brake						
Holding torque	M ₄	Nm	0	90.00	0	90.00
Rated voltage	U _N	V	0	24	0	24
Rated current	I _N	A	0	1.50	0	1.50
Maximum connection time	t ₁	ms	0	65	0	65
Maximum disconnection time	t ₂	ms	0	250	0	250
Fan data						
Rated voltage	U _N	V	230		115	
Rated current	I _N	A	0.26/0.23		0.46	
Frequency	f _N	Hz	50/60		60	
1) For tolerance details refer to chapter 6.4 Tolerances			Latest amendment: 2019-07-02			

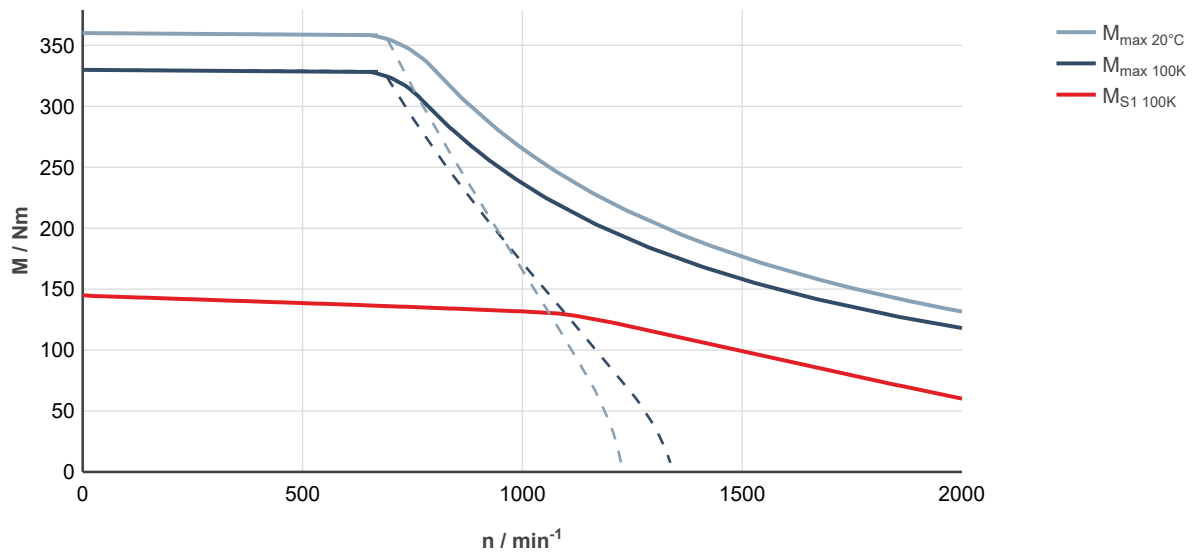

Fig. 256: MS2N10-F1BDA-___0-___-__, ctrlX DRIVE, uncontrolled supply 3 × AC 400 V

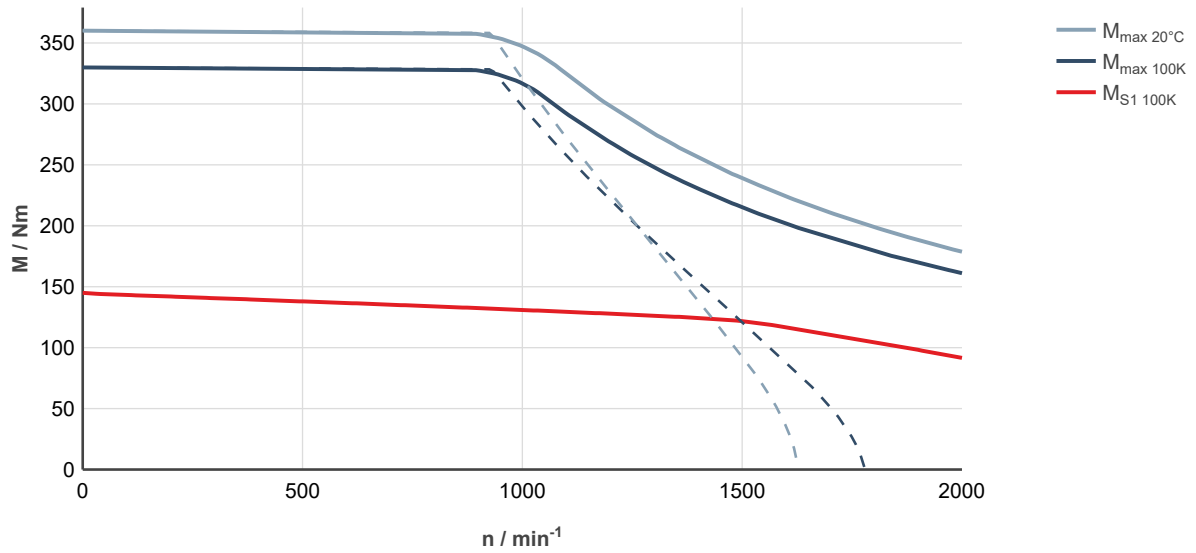

Fig. 257: MS2N10-F1BDA-___0-___-__, ctrlX DRIVE, controlled supply 3 × AC 400 ... 480 V

MS2N10-F1BHA/B

Designation	Symbol	Unit	MS2N10- F1BHA-__0- _N			
			MS2N10- F1BHA-__3- _N	MS2N10- F1BHB-__0- _N	MS2N10- F1BHB-__3- _N	
Standstill torque - 100K ¹⁾	M _{0 100K}	Nm	145			
Standstill current - 100K	I _{0 100K}	A	58.6			
Moment of inertia of rotor ¹⁾	J _{rot}	kg*m ²	0.0329	0.0356	0.0329	0.0356
Rated speed - 100K	n _{N 100K}	1/min	2000			
Rated torque - 100K ¹⁾	M _{N 100K}	Nm	105.5			
Rated current - 100K	I _{N 100K}	A	43.7			
Rated power - 100K ¹⁾	P _{N 100K}	kW	22.1			
Maximum torque 20 °C (cold) ¹⁾	M _{max 20°C}	Nm	360			
Maximum torque 100K (warm) ¹⁾	M _{max 100K}	Nm	330			
Maximum current	I _{max(rms)}	A	162			
Maximum speed (electrical)	n _{max el}	1/min	4000			
Maximum speed (mechanical)	n _{max mech}	1/min	6000			
Number of pole pairs	p		5			
Torque constant at 20 °C ¹⁾	K _m	Nm/A	2.7			
Voltage constant at 20 °C ¹⁾	K _E	V/1000 min ⁻¹	163.9			
Winding resistance at 20 °C	R ₁₂	Ohm	0.174			
Winding inductance	L _{12_min}	mH	3.61			
Leakage capacitance of the component	C _{ab}	nF	6.70			
Thermal time constant of winding	T _{th_W}	s	83.0			
Thermal time constant of motor	T _{th_M}	min	13.2			
Mass	m _{mot}	kg	60	67	60	67
Holding brake						
Holding torque	M ₄	Nm	0	90.00	0	90.00
Rated voltage	U _N	V	0	24	0	24
Rated current	I _N	A	0	1.50	0	1.50
Maximum connection time	t ₁	ms	0	65	0	65
Maximum disconnection time	t ₂	ms	0	250	0	250
Fan data						
Rated voltage	U _N	V	230		115	
Rated current	I _N	A	0.26/0.23		0.46	
Frequency	f _N	Hz	50/60		60	
1) For tolerance details refer to chapter 6.4 Tolerances			Latest amendment: 2019-07-02			

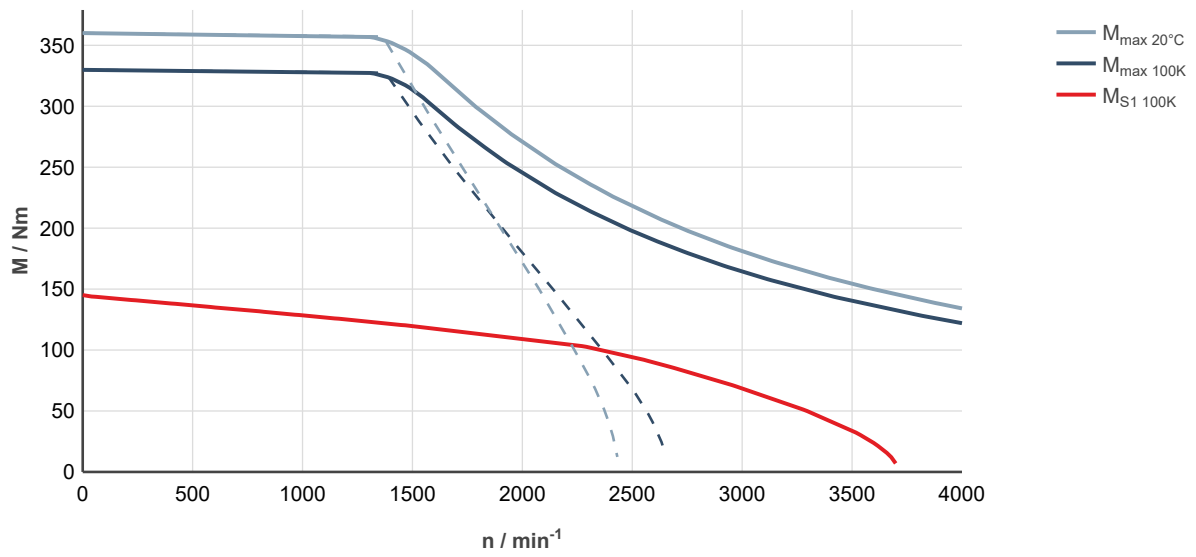

Fig. 258: MS2N10-F1BHA-___0-___-_, ctrIX DRIVE, uncontrolled supply 3 × AC 400 V

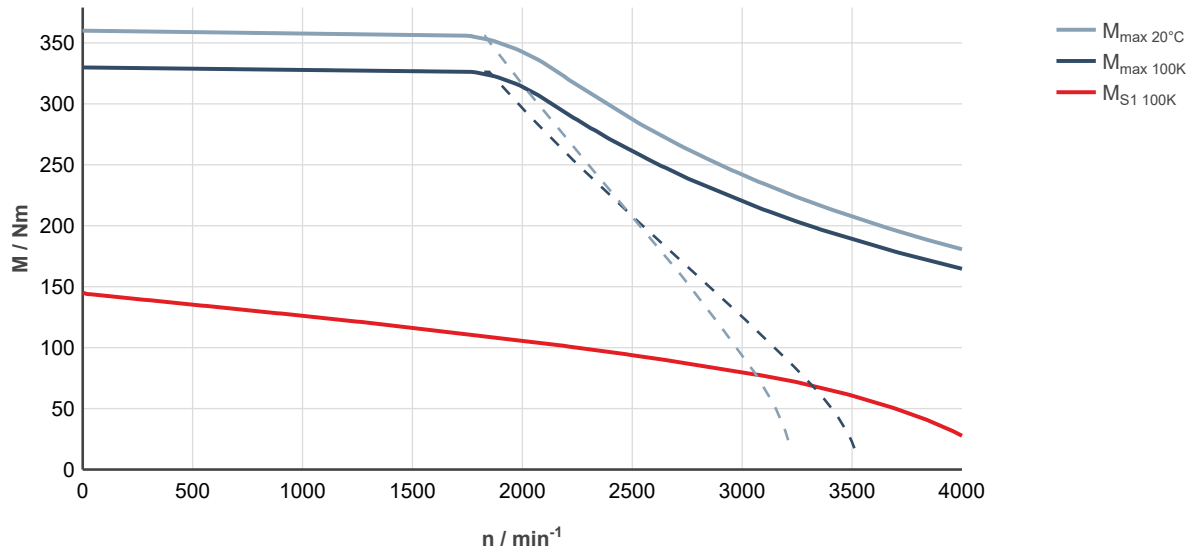

Fig. 259: MS2N10-F1BHA-___0-___-_, ctrIX DRIVE, controlled supply 3 × AC 400 ... 480 V

MS2N10-ROBLA/B

Designation	Symbol	Unit	MS2N10- ROBLA-__0- _N	MS2N10- ROBLA-__3- _N	MS2N10- ROBLB-__0- _N	MS2N10- ROBLB-__3- _N
Standstill torque - 100K ¹⁾	M _{0 100K}	Nm	138			
Standstill current - 100K	I _{0 100K}	A	72.4			
Moment of inertia of rotor ¹⁾	J _{rot}	kg*m ²	0.0147	0.0174	0.0147	0.0174
Rated speed - 100K	n _{N 100K}	1/min	2,500			
Rated torque - 100K ¹⁾	M _{N 100K}	Nm	79.9			
Rated current - 100K	I _{N 100K}	A	43.6			
Rated power - 100K ¹⁾	P _{N 100K}	kW	20.9			
Maximum torque 20 °C (cold) ¹⁾	M _{max 20°C}	Nm	355			
Maximum torque 100K (warm) ¹⁾	M _{max 100K}	Nm	325			
Maximum current	I _{max(eff)}	A	220			
Maximum speed (electrical)	n _{max el}	1/min	5,000			
Maximum speed (mechanical)	n _{max mech}	1/min	6,000			
Number of pole pairs	p		5			
Torque constant at 20 °C ¹⁾	K _m	Nm/A	2.0			
Voltage constant at 20 °C ¹⁾	K _E	V/1000 min ⁻¹	122.7			
Winding resistance at 20 °C	R ₁₂	Ohm	0.113			
Winding inductance	L _{12_min}	mH	2.30			
Leakage capacitance of the component	C _{ab}	nF	13.5			
Thermal time constant of winding	T _{th_W}	s	97.5			
Thermal time constant of motor	T _{th_M}	min	13.2			
Mass	m _{mot}	kg	55.0	62.0	55.0	62.0
Holding brake						
Holding torque	M ₄	Nm	0	90.00	0	90.00
Rated voltage	U _N	V	0	24	0	24
Rated current	I _N	A	0	1.50	0	1.50
Maximum connection time	t ₁	ms	0	65	0	65
Maximum disconnection time	t ₂	ms	0	250	0	250
Fan data						
Rated voltage	U _N	V	230		115	
Rated current	I _N	A	0.26/0.23		0.46	
Frequency	f _N	Hz	50/60		60	
1) For tolerance details refer to chapter 6.4 Tolerances			Latest amendment: 2022-05-04			

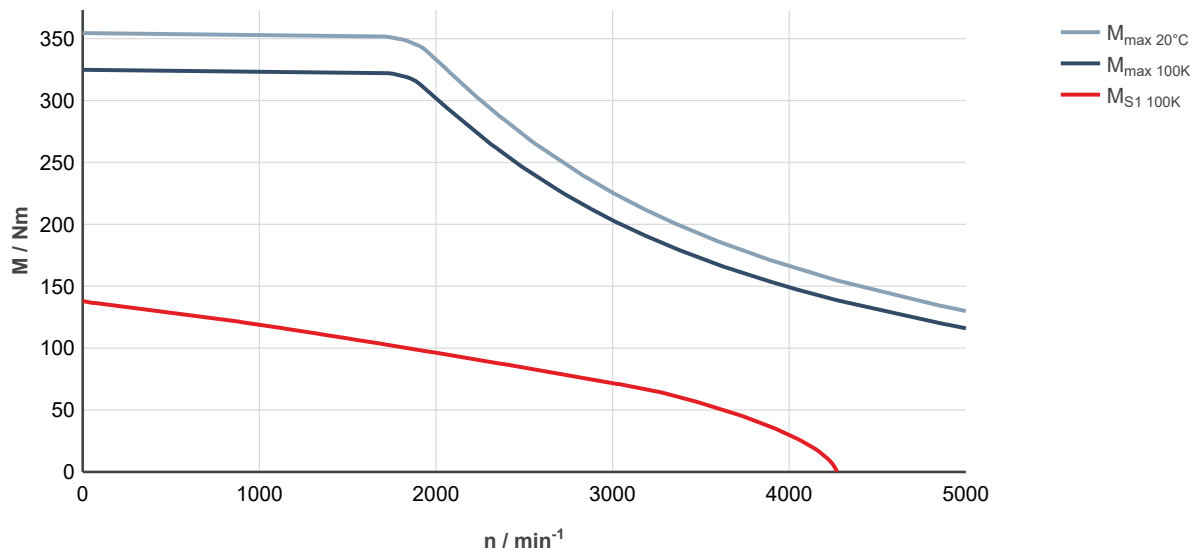

Fig. 260: MS2N10-R0BLA-___0-___-__, ctrlX DRIVE, uncontrolled supply 3 × AC 400 V

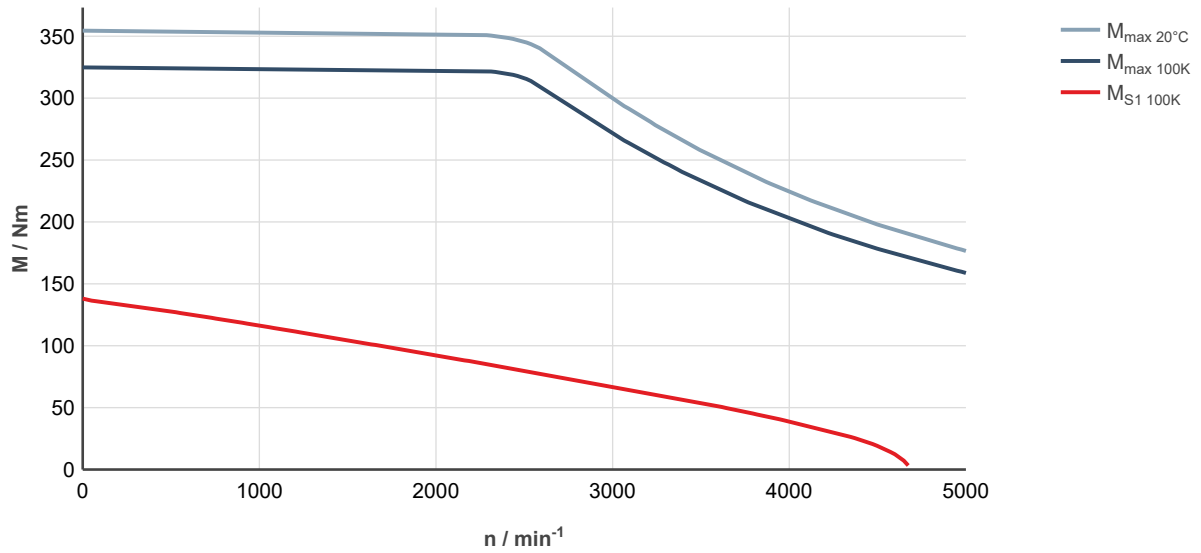

Fig. 261: MS2N10-R0BLA-___-___-__, ctrlX DRIVE, controlled supply 3 x AC 400 ... 480 V

7.6.3 Water cooling

MS2N10-C0BHL

Designation	Symbol	Unit	MS2N10-C0BHL-__0-N	MS2N10-C0BHL-__2-N
Standstill torque - 100K ¹⁾	M _{0 100K}	Nm	51.7	
Standstill current - 100K	I _{0 100K}	A	23.1	
Moment of inertia of rotor ¹⁾	J _{rot}	kg*m ²	0.0048	0.00627
Rated speed - 100K	n _{N 100K}	1/min	1720	
Rated torque - 100K ¹⁾	M _{N 100K}	Nm	44.7	
Rated current - 100K	I _{N 100K}	A	20	
Rated power - 100K ¹⁾	P _{N 100K}	kW	8.05	
Maximum torque 20 °C (cold) ¹⁾	M _{max 20°C}	Nm	76.8	
Maximum torque 100K (warm) ¹⁾	M _{max 100K}	Nm	70.5	
Maximum current	I _{max(eff)}	A	38.5	
Maximum speed (electrical)	n _{max el}	1/min	4,000	
Maximum speed (mechanical)	n _{max mech}	1/min	6,000	
Number of pole pairs	p		5	
Torque constant at 20 °C ¹⁾	K _m	Nm/A	2.60	
Voltage constant at 20 °C ¹⁾	K _E	V/1000 min ⁻¹	157.8	
Winding resistance at 20 °C	R ₁₂	Ohm	0.74	
Winding inductance	L _{12,min}	mH	18.7	
Leakage capacitance of the component	C _{ab}	nF	1.9	
Thermal time constant of winding	T _{th,W}	s	81.2	
Thermal time constant of motor	T _{th,M}	min	5.0	
Mass	m _{mot}	kg	29	34
Holding brake				
Holding torque	M ₄	Nm	0	53.00
Rated voltage	U _N	V	0	24
Rated current	I _N	A	0	1.00
Maximum connection time	t ₁	ms	0	70
Maximum disconnection time	t ₂	ms	0	220
Water cooling				
Power loss	P _V	kW	0.87	
Coolant inlet temperature	T _{in}	°C	10 ... 40	
Permissible coolant temperature increase for P _V	ΔT _{max}	K	8.0	
Required coolant flow for P _V	Q _{min}	l/min	1.56	
Pressure drop at Q _{min}	Δp	bar	0.10	
Maximum permissible inlet pressure	p _{max}	bar	6.0	
Volume of coolant duct	V _{cool}	l	0.15	
Material of coolant duct			Stainless steel	
1) For tolerance details refer to chapter 6.4 Tolerances			Latest amendment: 2019-07-02	

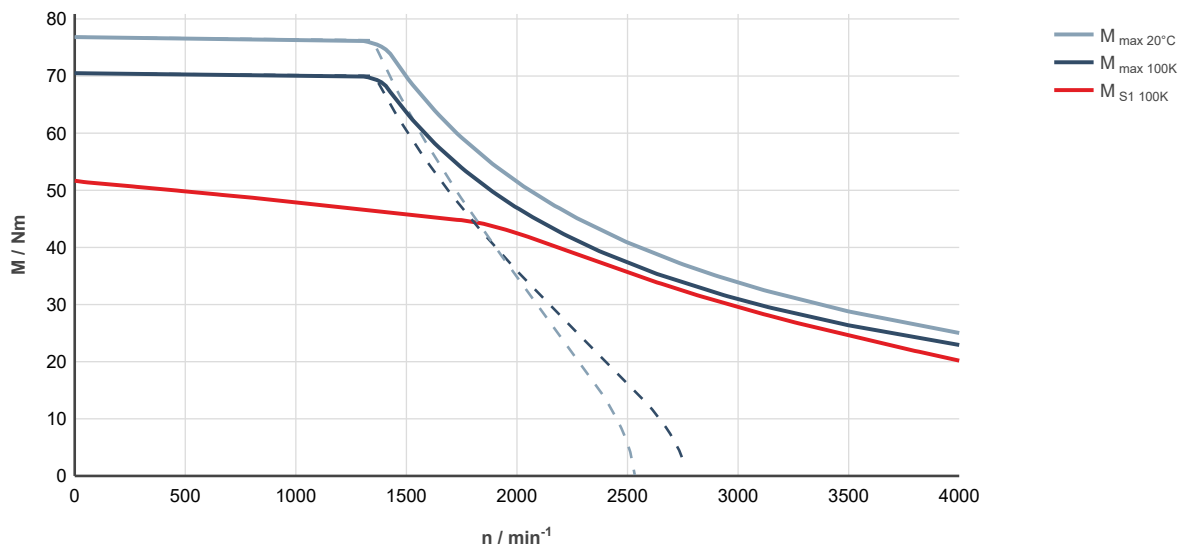

Fig. 262: MS2N10-C0BHL-___0-___-_0, ctrlX DRIVE, uncontrolled supply 3 × AC 400 V

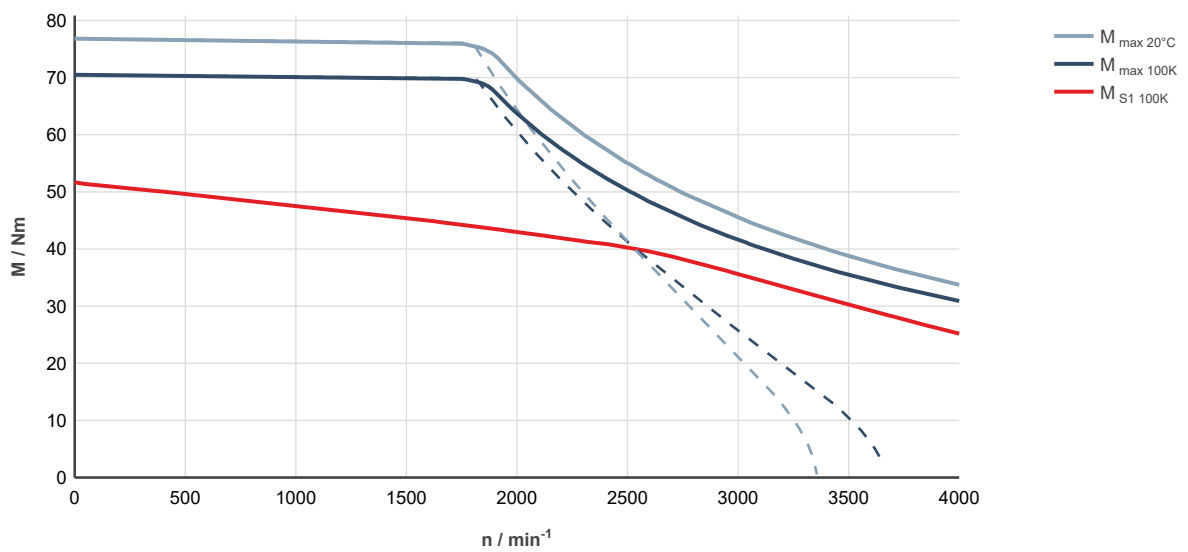

Fig. 263: MS2N10-C0BHL-___0-___-_0, ctrlX DRIVE, controlled supply 3 x AC 400 ... 480 V

MS2N10-C0BNL

Designation	Symbol	Unit	MS2N10-C0BNL-__0-N	MS2N10-C0BNL-__2-N
Standstill torque - 100K ¹⁾	$M_{0\ 100K}$	Nm	51.7	
Standstill current - 100K	$I_{0\ 100K}$	A	30.8	
Moment of inertia of rotor ¹⁾	J_{rot}	kg*m ²	0.0048	0.00627
Rated speed - 100K	$n_{N\ 100K}$	1/min	2310	
Rated torque - 100K ¹⁾	$M_{N\ 100K}$	Nm	40.4	
Rated current - 100K	$I_{N\ 100K}$	A	24.1	
Rated power - 100K ¹⁾	$P_{N\ 100K}$	kW	9.8	
Maximum torque 20 °C (cold) ¹⁾	$M_{max\ 20°C}$	Nm	76.8	
Maximum torque 100K (warm) ¹⁾	$M_{max\ 100K}$	Nm	70.4	
Maximum current	$I_{max(rms)}$	A	51.3	
Maximum speed (electrical)	$n_{max\ el}$	1/min	6000	
Maximum speed (mechanical)	$n_{max\ mech}$	1/min	6000	
Number of pole pairs	p		5	
Torque constant at 20 °C ¹⁾	K_m	Nm/A	1.95	
Voltage constant at 20 °C ¹⁾	K_E	V/1000 min ⁻¹	118.4	
Winding resistance at 20 °C	R_{12}	Ohm	0.441	
Winding inductance	L_{12_min}	mH	10.67	
Leakage capacitance of the component	C_{ab}	nF	1.97	
Thermal time constant of winding	T_{th_W}	s	81.2	
Thermal time constant of motor	T_{th_M}	min	5.0	
Mass	m_{mot}	kg	29	34
Holding brake				
Holding torque	M_4	Nm	0	53.00
Rated voltage	U_N	V	0	24
Rated current	I_N	A	0	1.00
Maximum connection time	t_1	ms	0	70
Maximum disconnection time	t_2	ms	0	220
Water cooling				
Power loss	P_V	kW	0.87	
Coolant inlet temperature	T_{in}	°C	10 ... 40	
Permissible coolant temperature increase for P_V	ΔT_{max}	K	8.0	
Required coolant flow for P_V	Q_{min}	l/min	1.56	
Pressure drop at Q_{min}	Δp	bar	0.10	
Maximum permissible inlet pressure	p_{max}	bar	6.0	
Volume of coolant duct	V_{cool}	l	0.15	
Material of coolant duct			Stainless steel	
1) For tolerance details refer to chapter 6.4 Tolerances			Latest amendment: 2019-07-02	

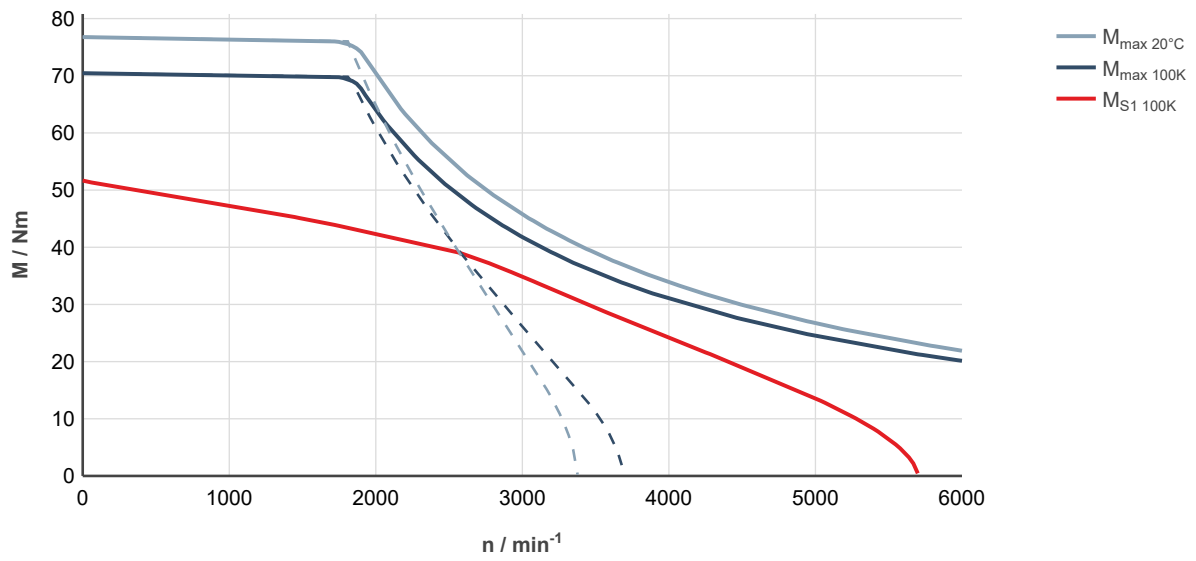

Fig. 264: MS2N10-C0BNL-___0-___-___, ctrIX DRIVE, uncontrolled supply 3 × AC 400 V

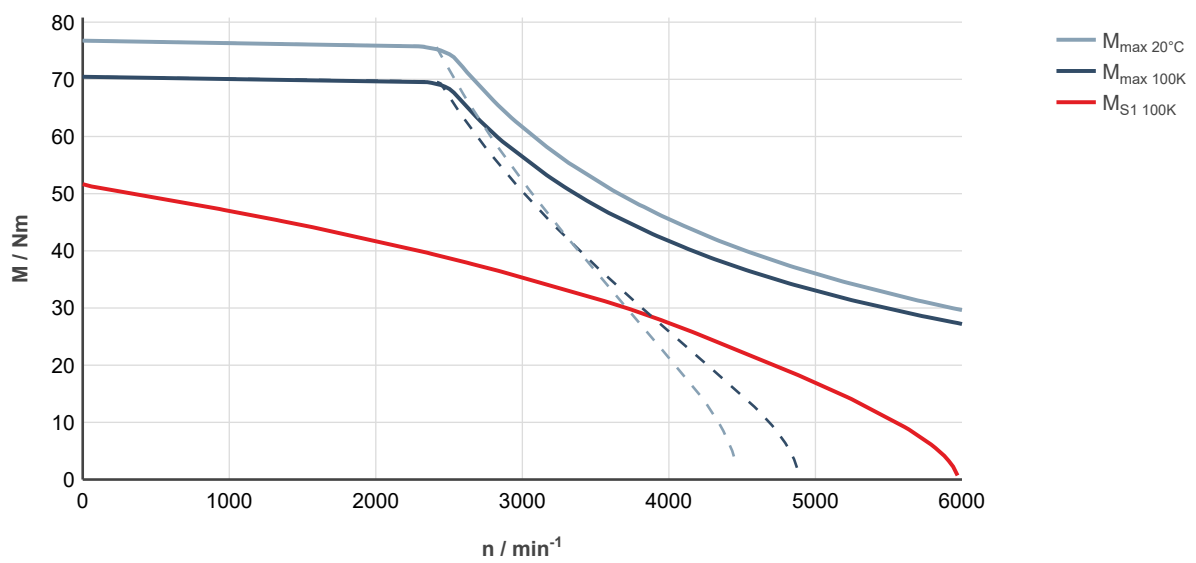

Fig. 265: MS2N10-C0BNL-___0-___-___, ctrIX DRIVE, controlled supply 3 × AC 400 ... 480 V

MS2N10-C1BNL

Designation	Symbol	Unit	MS2N10-C1BNL-__0-N	MS2N10-C1BNL-__2-N
Standstill torque - 100K ¹⁾	$M_{0\ 100K}$	Nm	48.0	
Standstill current - 100K	$I_{0\ 100K}$	A	29.9	
Moment of inertia of rotor ¹⁾	J_{rot}	kg*m ²	0.0092	0.01067
Rated speed - 100K	$n_{N\ 100K}$	1/min	2900	
Rated torque - 100K ¹⁾	$M_{N\ 100K}$	Nm	33.4	
Rated current - 100K	$I_{N\ 100K}$	A	21.2	
Rated power - 100K ¹⁾	$P_{N\ 100K}$	kW	10.15	
Maximum torque 20 °C (cold) ¹⁾	$M_{max\ 20°C}$	Nm	86.5	
Maximum torque 100K (warm) ¹⁾	$M_{max\ 100K}$	Nm	79.4	
Maximum current	$I_{max(rms)}$	A	60.8	
Maximum speed (electrical)	$n_{max\ el}$	1/min	6000	
Maximum speed (mechanical)	$n_{max\ mech}$	1/min	6000	
Number of pole pairs	p		5	
Torque constant at 20 °C ¹⁾	K_m	Nm/A	1.78	
Voltage constant at 20 °C ¹⁾	K_E	V/1000 min ⁻¹	107.9	
Winding resistance at 20 °C	R_{12}	Ohm	0.439	
Winding inductance	L_{12_min}	mH	6.6	
Leakage capacitance of the component	C_{ab}	nF	1.52	
Thermal time constant of winding	T_{th_W}	s	68.5	
Thermal time constant of motor	T_{th_M}	min	5.0	
Mass	m_{mot}	kg	28.0	33
Holding brake				
Holding torque	M_4	Nm	0	53.00
Rated voltage	U_N	V	0	24
Rated current	I_N	A	0	1.00
Maximum connection time	t_1	ms	0	70
Maximum disconnection time	t_2	ms	0	220
Water cooling				
Power loss	P_V	kW	0.82	
Coolant inlet temperature	T_{in}	°C	10 ... 40	
Permissible coolant temperature increase for P_V	ΔT_{max}	K	8.0	
Required coolant flow for P_V	Q_{min}	l/min	1.47	
Pressure drop at Q_{min}	Δp	bar	0.10	
Maximum permissible inlet pressure	p_{max}	bar	6.0	
Volume of coolant duct	V_{cool}	l	0.15	
Material of coolant duct			Stainless steel	
1) For tolerance details refer to chapter 6.4 Tolerances			Latest amendment: 2019-07-02	

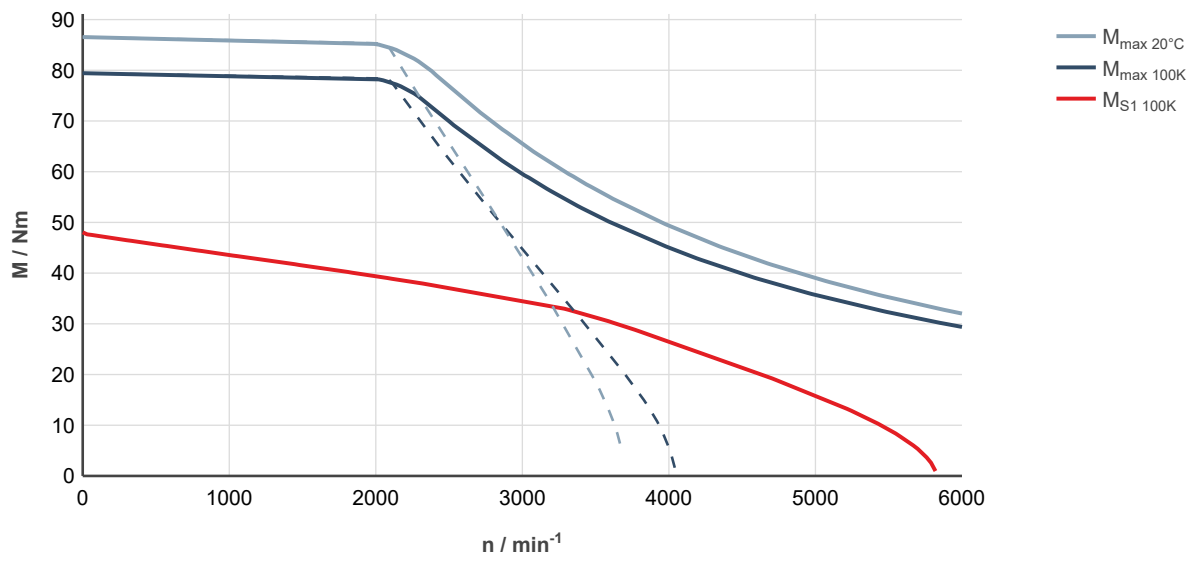

Fig. 266: MS2N10-C1BNL-___0-___-___, ctrIX DRIVE, uncontrolled supply 3 × AC 400 V

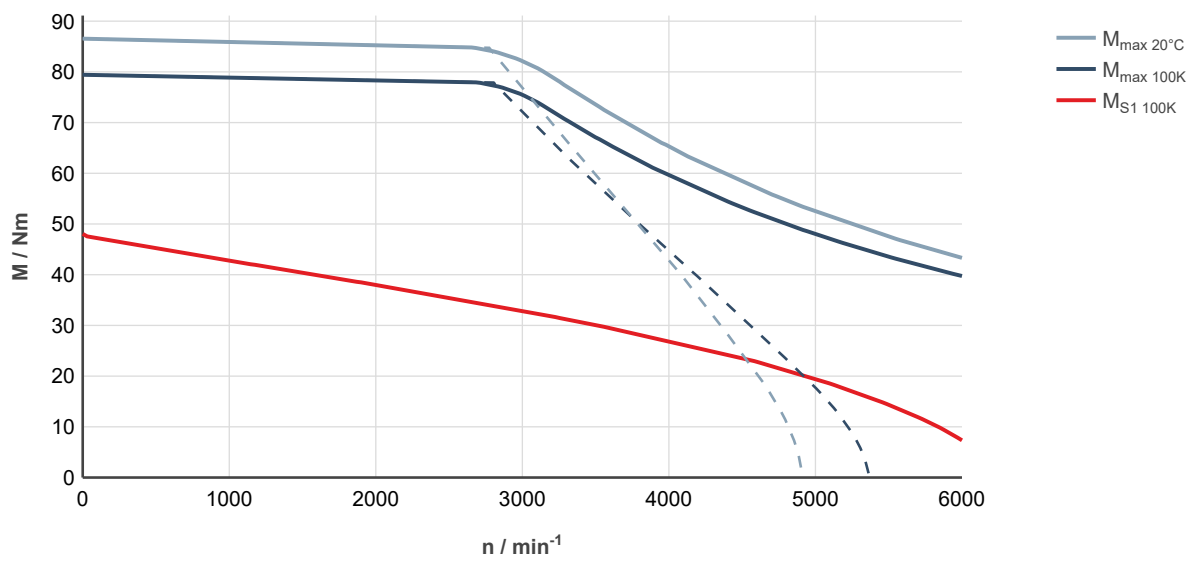

Fig. 267: MS2N10-C1BNL-___0-___-___, ctrIX DRIVE, controlled supply 3 × AC 400 ... 480 V

MS2N10-D0BHL

Designation	Symbol	Unit	MS2N10-D0BHL-__0-_N	MS2N10-D0BHL-__2-_N
Standstill torque - 100K ¹⁾	$M_{0\ 100K}$	Nm	107.5	
Standstill current - 100K	$I_{0\ 100K}$	A	43.7	
Moment of inertia of rotor ¹⁾	J_{rot}	kg*m ²	0.0081	0.00957
Rated speed - 100K	$n_{N\ 100K}$	1/min	1550	
Rated torque - 100K ¹⁾	$M_{N\ 100K}$	Nm	93.5	
Rated current - 100K	$I_{N\ 100K}$	A	38.0	
Rated power - 100K ¹⁾	$P_{N\ 100K}$	kW	15.2	
Maximum torque 20 °C (cold) ¹⁾	$M_{max\ 20°C}$	Nm	155	
Maximum torque 100K (warm) ¹⁾	$M_{max\ 100K}$	Nm	142	
Maximum current	$I_{max(rms)}$	A	70	
Maximum speed (electrical)	$n_{max\ el}$	1/min	4000	
Maximum speed (mechanical)	$n_{max\ mech}$	1/min	6000	
Number of pole pairs	p		5	
Torque constant at 20 °C ¹⁾	K_m	Nm/A	2.86	
Voltage constant at 20 °C ¹⁾	K_E	V/1000 min ⁻¹	173.5	
Winding resistance at 20 °C	R_{12}	Ohm	0.386	
Winding inductance	L_{12_min}	mH	10.3	
Leakage capacitance of the component	C_{ab}	nF	3.15	
Thermal time constant of winding	T_{th_W}	s	90.0	
Thermal time constant of motor	T_{th_M}	min	5.1	
Mass	m_{mot}	kg	39	44
Holding brake				
Holding torque	M_4	Nm	0	53.00
Rated voltage	U_N	V	0	24
Rated current	I_N	A	0	1.00
Maximum connection time	t_1	ms	0	70
Maximum disconnection time	t_2	ms	0	220
Water cooling				
Power loss	P_V	kW	1.55	
Coolant inlet temperature	T_{in}	°C	10 ... 40	
Permissible coolant temperature increase for P_V	ΔT_{max}	K	8.0	
Required coolant flow for P_V	Q_{min}	l/min	2.78	
Pressure drop at Q_{min}	Δp	bar	0.185	
Maximum permissible inlet pressure	p_{max}	bar	6.0	
Volume of coolant duct	V_{cool}	l	0.25	
Material of coolant duct			Stainless steel	
1) For tolerance details refer to chapter 6.4 Tolerances			Latest amendment: 2019-07-02	

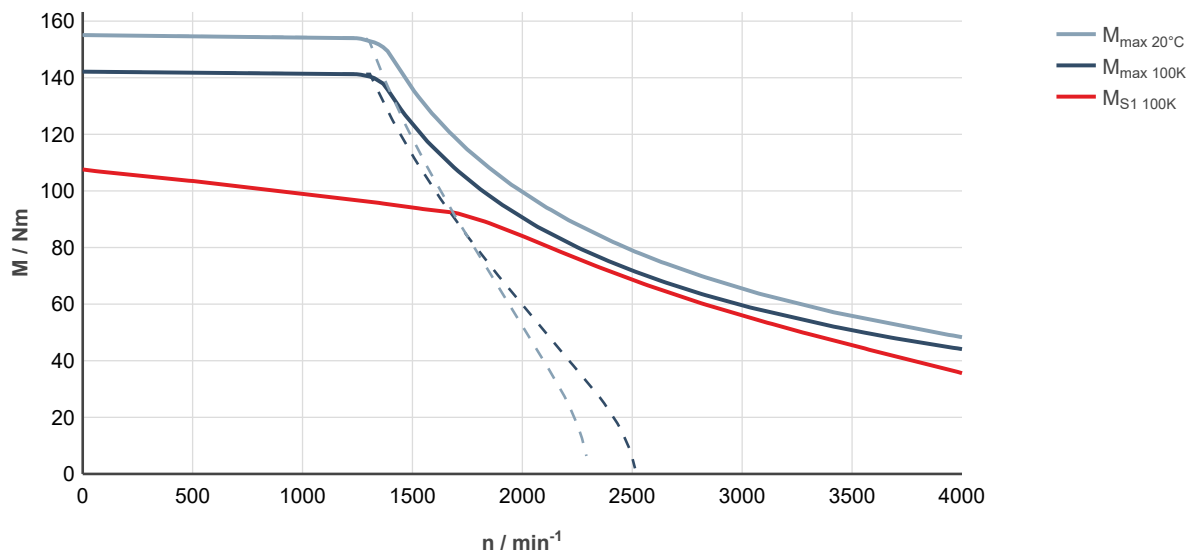

Fig. 268: MS2N10-D0BHL-___0-___-___, ctrIX DRIVE, uncontrolled supply 3 × AC 400 V

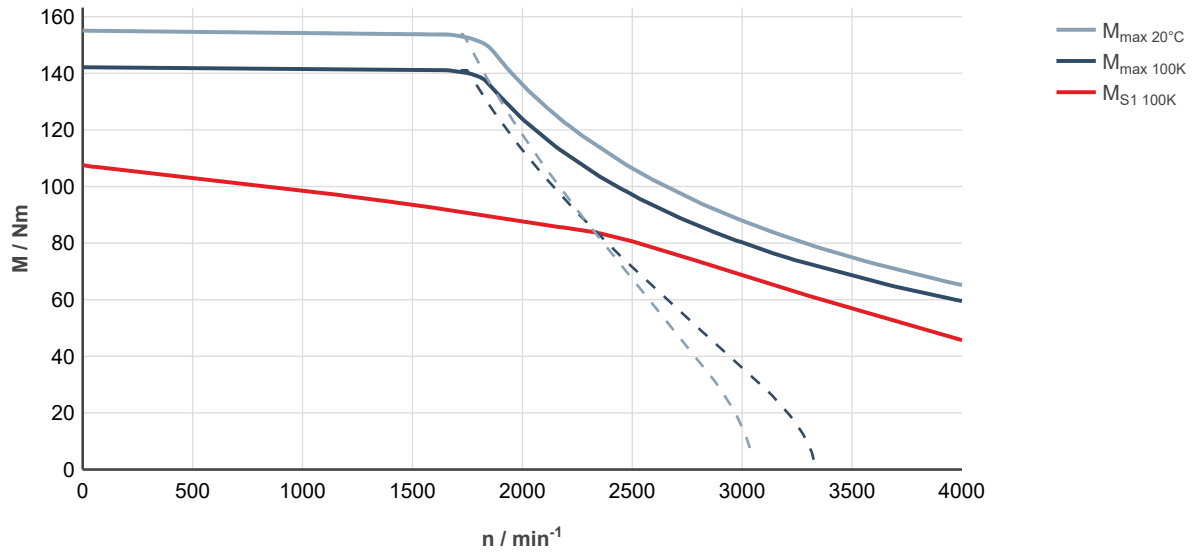

Fig. 269: MS2N10-D0BHL-___0-___-___, ctrIX DRIVE, controlled supply 3 × AC 400 ... 480 V

MS2N10-D0BNL

Designation	Symbol	Unit	MS2N10-D0BNL-__0-_N	MS2N10-D0BNL-__2-_N
Standstill torque - 100K ¹⁾	$M_{0\ 100K}$	Nm	107.5	
Standstill current - 100K	$I_{0\ 100K}$	A	64.7	
Moment of inertia of rotor ¹⁾	J_{rot}	kg*m ²	0.0081	0.00957
Rated speed - 100K	$n_{N\ 100K}$	1/min	2420	
Rated torque - 100K ¹⁾	$M_{N\ 100K}$	Nm	79.6	
Rated current - 100K	$I_{N\ 100K}$	A	47.6	
Rated power - 100K ¹⁾	$P_{N\ 100K}$	kW	20.2	
Maximum torque 20 °C (cold) ¹⁾	$M_{max\ 20°C}$	Nm	155	
Maximum torque 100K (warm) ¹⁾	$M_{max\ 100K}$	Nm	142	
Maximum current	$I_{max(rms)}$	A	102.5	
Maximum speed (electrical)	$n_{max\ el}$	1/min	6000	
Maximum speed (mechanical)	$n_{max\ mech}$	1/min	6000	
Number of pole pairs	p		5	
Torque constant at 20 °C ¹⁾	K_m	Nm/A	1.95	
Voltage constant at 20 °C ¹⁾	K_E	V/1000 min ⁻¹	118.5	
Winding resistance at 20 °C	R_{12}	Ohm	0.18	
Winding inductance	L_{12_min}	mH	5.05	
Leakage capacitance of the component	C_{ab}	nF	4.1	
Thermal time constant of winding	T_{th_W}	s	90.0	
Thermal time constant of motor	T_{th_M}	min	5.1	
Mass	m_{mot}	kg	39	44
Holding brake				
Holding torque	M_4	Nm	0	53.00
Rated voltage	U_N	V	0	24
Rated current	I_N	A	0	1.00
Maximum connection time	t_1	ms	0	70
Maximum disconnection time	t_2	ms	0	220
Water cooling				
Power loss	P_V	kW	1.55	
Coolant inlet temperature	T_{in}	°C	10 ... 40	
Permissible coolant temperature increase for P_V	ΔT_{max}	K	8.0	
Required coolant flow for P_V	Q_{min}	l/min	2.78	
Pressure drop at Q_{min}	Δp	bar	0.185	
Maximum permissible inlet pressure	p_{max}	bar	6.0	
Volume of coolant duct	V_{cool}	l	0.25	
Material of coolant duct			Stainless steel	
1) For tolerance details refer to chapter 6.4 Tolerances			Latest amendment: 2019-07-02	

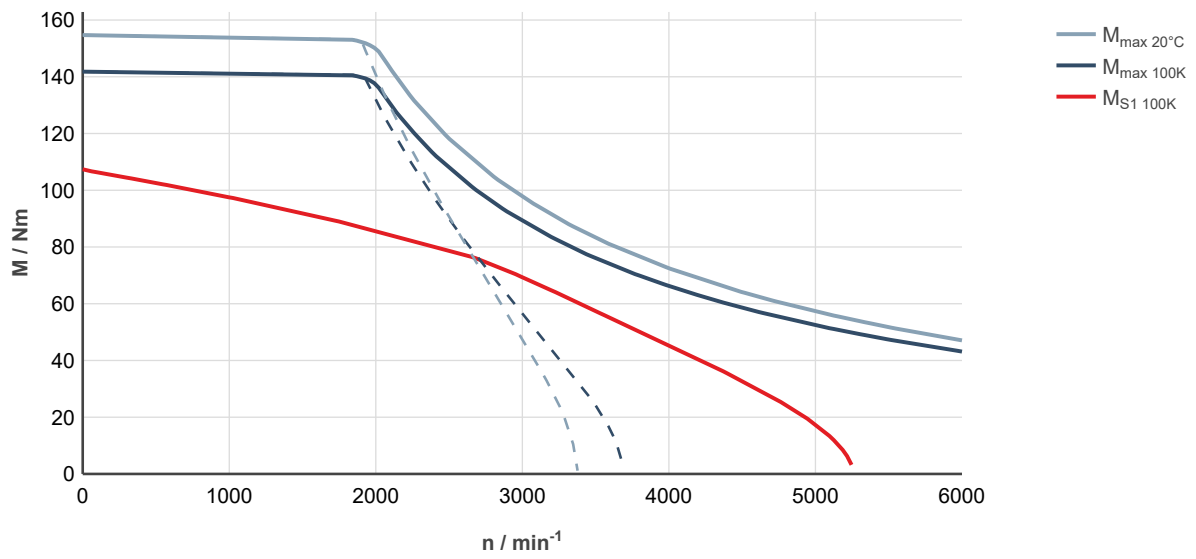

Fig. 270: MS2N10-D0BNL-___0-___-___, ctrIX DRIVE, uncontrolled supply 3 × AC 400 V

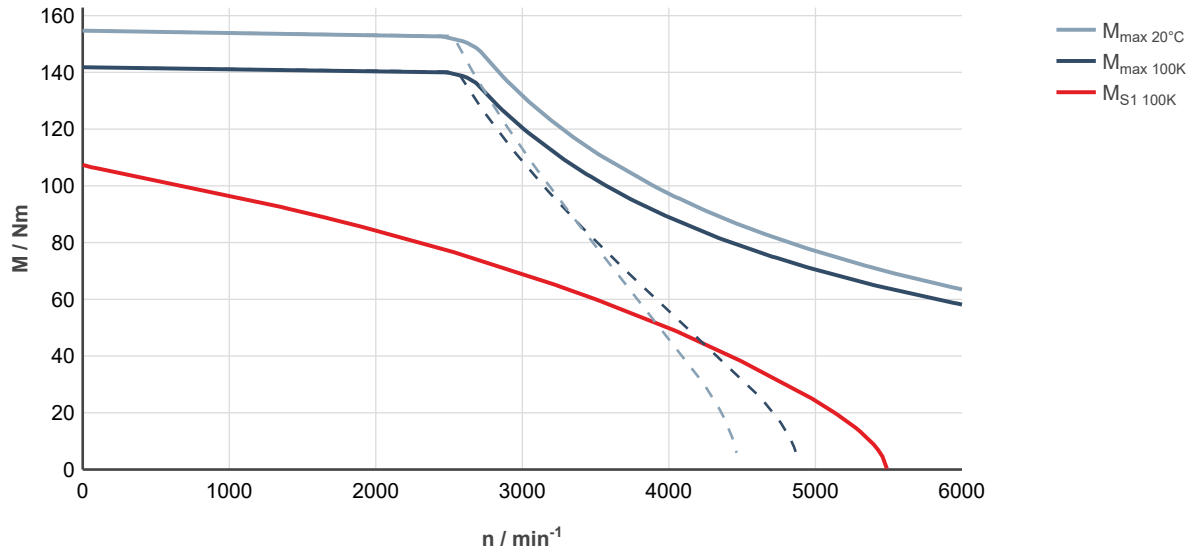

Fig. 271: MS2N10-D0BNL-___0-___-___, ctrIX DRIVE, controlled supply 3 × AC 400 ... 480 V

MS2N10-D1BNL

Designation	Symbol	Unit	MS2N10-D1BNL-__0-N	MS2N10-D1BNL-__2-N
Standstill torque - 100K ¹⁾	$M_{0\ 100K}$	Nm	101.0	
Standstill current - 100K	$I_{0\ 100K}$	A	63.3	
Moment of inertia of rotor ¹⁾	J_{rot}	kg*m ²	0.0171	0.01857
Rated speed - 100K	$n_{N\ 100K}$	1/min	3000	
Rated torque - 100K ¹⁾	$M_{N\ 100K}$	Nm	61.9	
Rated current - 100K	$I_{N\ 100K}$	A	39.6	
Rated power - 100K ¹⁾	$P_{N\ 100K}$	kW	19.4	
Maximum torque 20 °C (cold) ¹⁾	$M_{max\ 20°C}$	Nm	174.0	
Maximum torque 100K (warm) ¹⁾	$M_{max\ 100K}$	Nm	160.0	
Maximum current	$I_{max(rms)}$	A	121.5	
Maximum speed (electrical)	$n_{max\ el}$	1/min	6000	
Maximum speed (mechanical)	$n_{max\ mech}$	1/min	6000	
Number of pole pairs	p		5	
Torque constant at 20 °C ¹⁾	K_m	Nm/A	1.76	
Voltage constant at 20 °C ¹⁾	K_E	V/1000 min ⁻¹	107.6	
Winding resistance at 20 °C	R_{12}	Ohm	0.178	
Winding inductance	L_{12_min}	mH	3.23	
Leakage capacitance of the component	C_{ab}	nF	3.33	
Thermal time constant of winding	T_{th_W}	s	74.2	
Thermal time constant of motor	T_{th_M}	min	5.1	
Mass	m_{mot}	kg	39	44
Holding brake				
Holding torque	M_4	Nm	0	53.00
Rated voltage	U_N	V	0	24
Rated current	I_N	A	0	1.00
Maximum connection time	t_1	ms	0	70
Maximum disconnection time	t_2	ms	0	220
Water cooling				
Power loss	P_V	kW	1.47	
Coolant inlet temperature	T_{in}	°C	10 ... 40	
Permissible coolant temperature increase for P_V	ΔT_{max}	K	8.0	
Required coolant flow for P_V	Q_{min}	l/min	2.64	
Pressure drop at Q_{min}	Δp	bar	0.17	
Maximum permissible inlet pressure	p_{max}	bar	6.0	
Volume of coolant duct	V_{cool}	l	0.25	
Material of coolant duct			Stainless steel	
1) For tolerance details refer to chapter 6.4 Tolerances			Latest amendment: 2019-07-02	

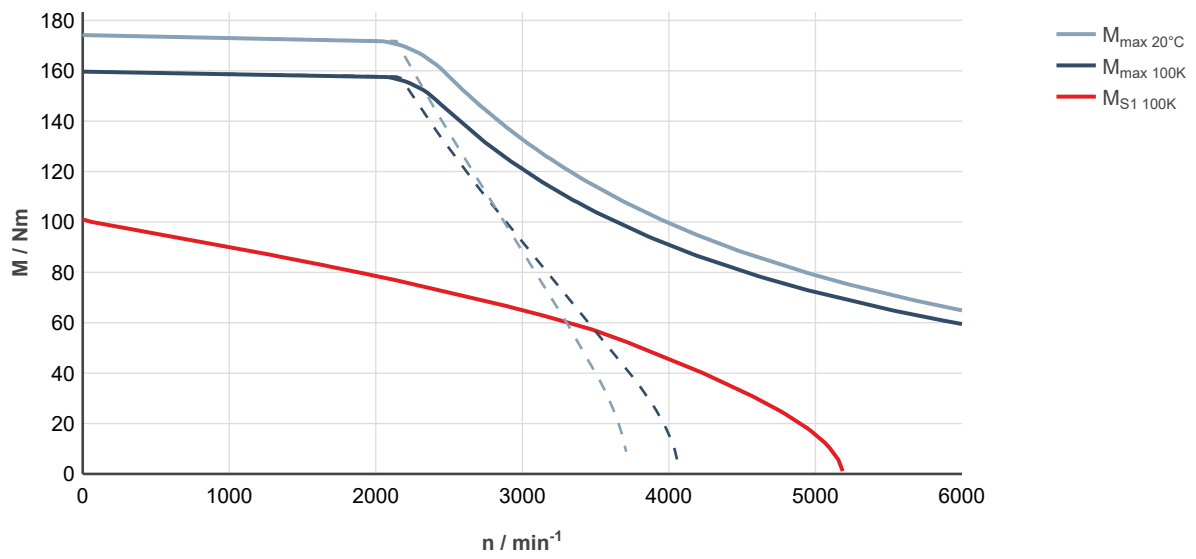

Fig. 272: MS2N10-D1BNL-___0-___-___, ctrIX DRIVE, uncontrolled supply 3 × AC 400 V

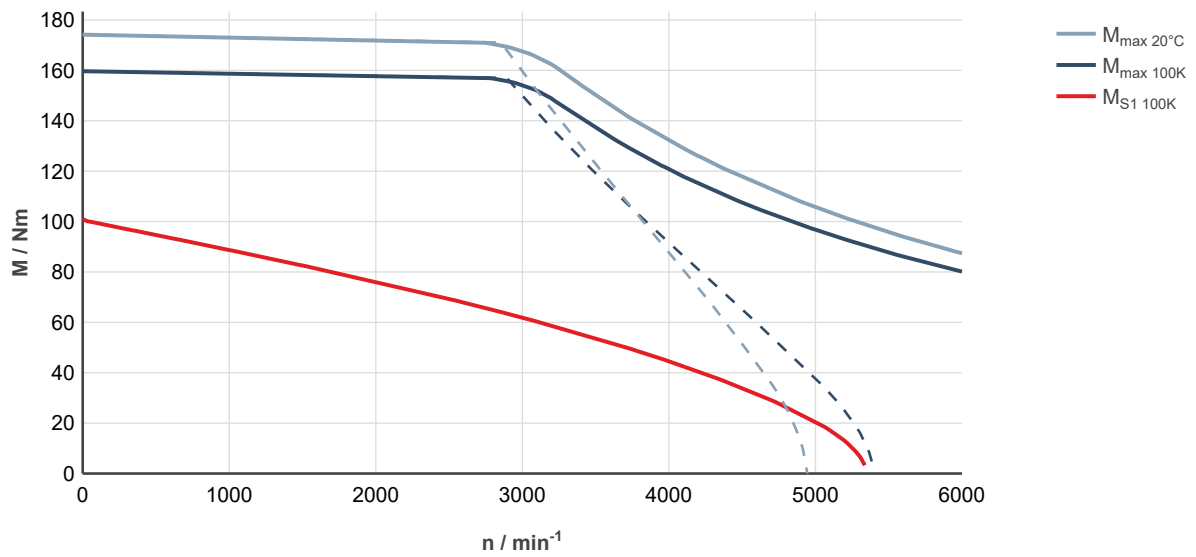

Fig. 273: MS2N10-D1BNL-___0-___-___, ctrIX DRIVE, controlled supply 3 × AC 400 ... 480 V

MS2N10-E0BHL

Designation	Symbol	Unit	MS2N10-E0BHL-__0-_N	MS2N10-E0BHL-__3-_N
Standstill torque - 100K ¹⁾	$M_{0\ 100K}$	Nm	162	
Standstill current - 100K	$I_{0\ 100K}$	A	65.4	
Moment of inertia of rotor ¹⁾	J_{rot}	kg*m ²	0.0114	0.0141
Rated speed - 100K	$n_{N\ 100K}$	1/min	1540	
Rated torque - 100K ¹⁾	$M_{N\ 100K}$	Nm	137	
Rated current - 100K	$I_{N\ 100K}$	A	55.2	
Rated power - 100K ¹⁾	$P_{N\ 100K}$	kW	22.1	
Maximum torque 20 °C (cold) ¹⁾	$M_{max\ 20°C}$	Nm	234	
Maximum torque 100K (warm) ¹⁾	$M_{max\ 100K}$	Nm	214	
Maximum current	$I_{max(rms)}$	A	102.5	
Maximum speed (electrical)	$n_{max\ el}$	1/min	4000	
Maximum speed (mechanical)	$n_{max\ mech}$	1/min	6000	
Number of pole pairs	p		5	
Torque constant at 20 °C ¹⁾	K_m	Nm/A	2.9	
Voltage constant at 20 °C ¹⁾	K_E	V/1000 min ⁻¹	176.4	
Winding resistance at 20 °C	R_{12}	Ohm	0.244	
Winding inductance	L_{12_min}	mH	7.43	
Leakage capacitance of the component	C_{ab}	nF	6.2	
Thermal time constant of winding	T_{th_W}	s	97.5	
Thermal time constant of motor	T_{th_M}	min	5.2	
Mass	m_{mot}	kg	49	56
Holding brake				
Holding torque	M_4	Nm	0	90.00
Rated voltage	U_N	V	0	24
Rated current	I_N	A	0	1.50
Maximum connection time	t_1	ms	0	65
Maximum disconnection time	t_2	ms	0	250
Water cooling				
Power loss	P_V	kW	2.22	
Coolant inlet temperature	T_{in}	°C	10 ... 40	
Permissible coolant temperature increase for P_V	ΔT_{max}	K	8.0	
Required coolant flow for P_V	Q_{min}	l/min	3.98	
Pressure drop at Q_{min}	Δp	bar	0.36	
Maximum permissible inlet pressure	p_{max}	bar	6.0	
Volume of coolant duct	V_{cool}	l	0.35	
Material of coolant duct			Stainless steel	
1) For tolerance details refer to chapter 6.4 Tolerances			Latest amendment: 2019-07-02	

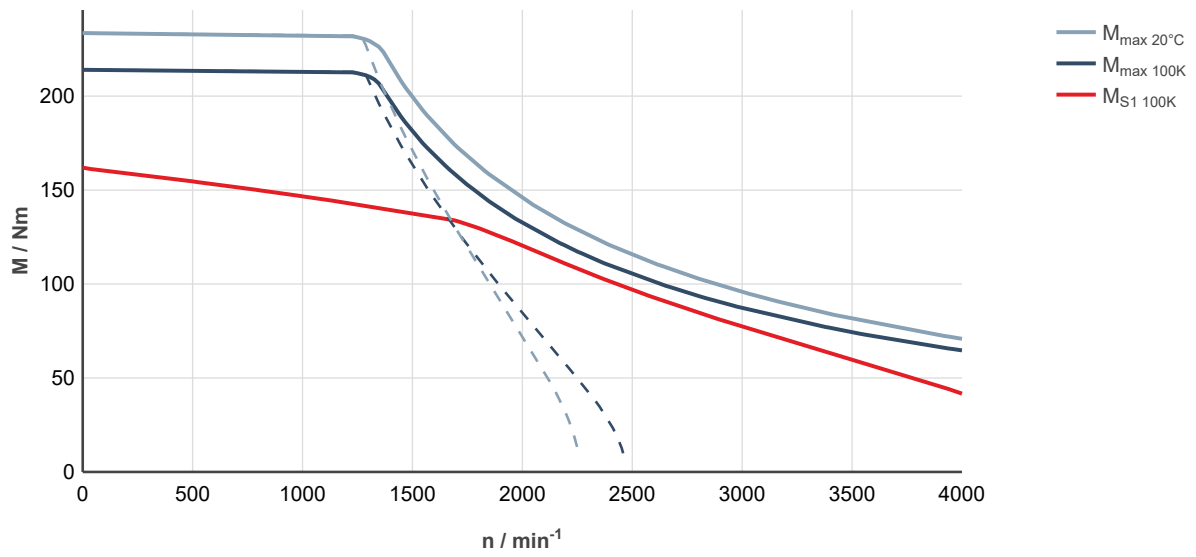

Fig. 274: MS2N10-E0BHL-___0-___-__, ctrlX DRIVE, uncontrolled supply 3 × AC 400 V

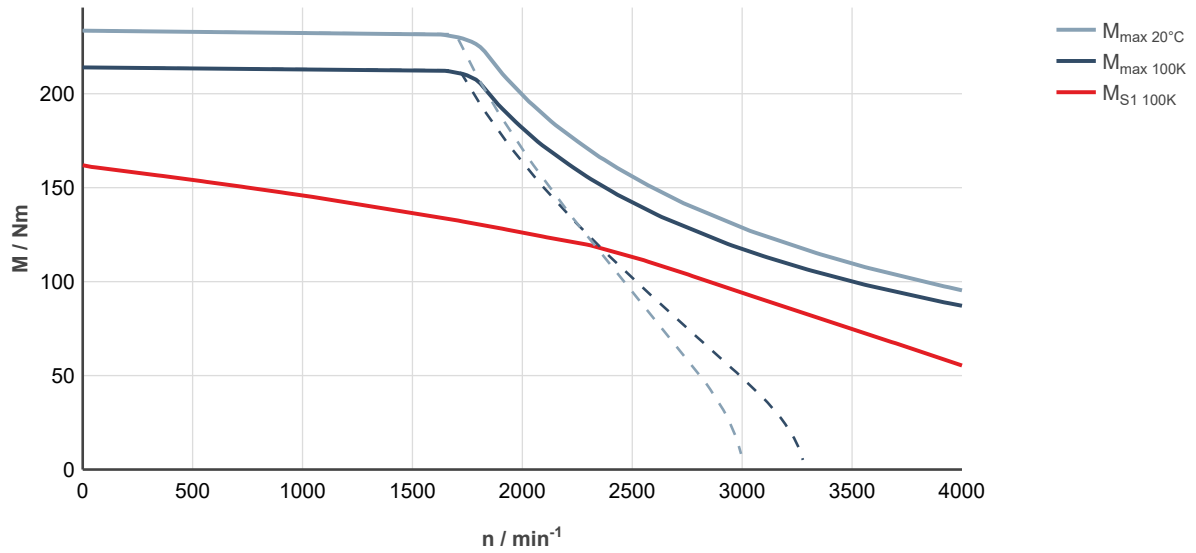

Fig. 275: MS2N10-E0BHL-___0-___-__, ctrlX DRIVE, controlled supply 3 × AC 400 ... 480 V

MS2N10-E0BNL

Designation	Symbol	Unit	MS2N10-E0BNL-__0-N	MS2N10-E0BNL-__3-N
Standstill torque - 100K ¹⁾	$M_{0\ 100K}$	Nm	162	
Standstill current - 100K	$I_{0\ 100K}$	A	90	
Moment of inertia of rotor ¹⁾	J_{rot}	kg*m ²	0.0114	0.0141
Rated speed - 100K	$n_{N\ 100K}$	1/min	2220	
Rated torque - 100K ¹⁾	$M_{N\ 100K}$	Nm	118.5	
Rated current - 100K	$I_{N\ 100K}$	A	65.6	
Rated power - 100K ¹⁾	$P_{N\ 100K}$	kW	27.5	
Maximum torque 20 °C (cold) ¹⁾	$M_{max\ 20°C}$	Nm	234	
Maximum torque 100K (warm) ¹⁾	$M_{max\ 100K}$	Nm	214	
Maximum current	$I_{max(rms)}$	A	140	
Maximum speed (electrical)	$n_{max\ el}$	1/min	6000	
Maximum speed (mechanical)	$n_{max\ mech}$	1/min	6000	
Number of pole pairs	p		5	
Torque constant at 20 °C ¹⁾	K_m	Nm/A	2.1	
Voltage constant at 20 °C ¹⁾	K_E	V/1000 min ⁻¹	128.5	
Winding resistance at 20 °C	R_{12}	Ohm	0.133	
Winding inductance	L_{12_min}	mH	4.00	
Leakage capacitance of the component	C_{ab}	nF	6.2	
Thermal time constant of winding	T_{th_W}	s	97.5	
Thermal time constant of motor	T_{th_M}	min	5.2	
Mass	m_{mot}	kg	49	56
Holding brake				
Holding torque	M_4	Nm	0	90.00
Rated voltage	U_N	V	0	24
Rated current	I_N	A	0	1.50
Maximum connection time	t_1	ms	0	65
Maximum disconnection time	t_2	ms	0	250
Water cooling				
Power loss	P_V	kW	2.22	
Coolant inlet temperature	T_{in}	°C	10 ... 40	
Permissible coolant temperature increase for P_V	ΔT_{max}	K	8.0	
Required coolant flow for P_V	Q_{min}	l/min	3.98	
Pressure drop at Q_{min}	Δp	bar	0.36	
Maximum permissible inlet pressure	p_{max}	bar	6.0	
Volume of coolant duct	V_{cool}	l	0.35	
Material of coolant duct			Stainless steel	
1) For tolerance details refer to chapter 6.4 Tolerances			Latest amendment: 2019-07-02	

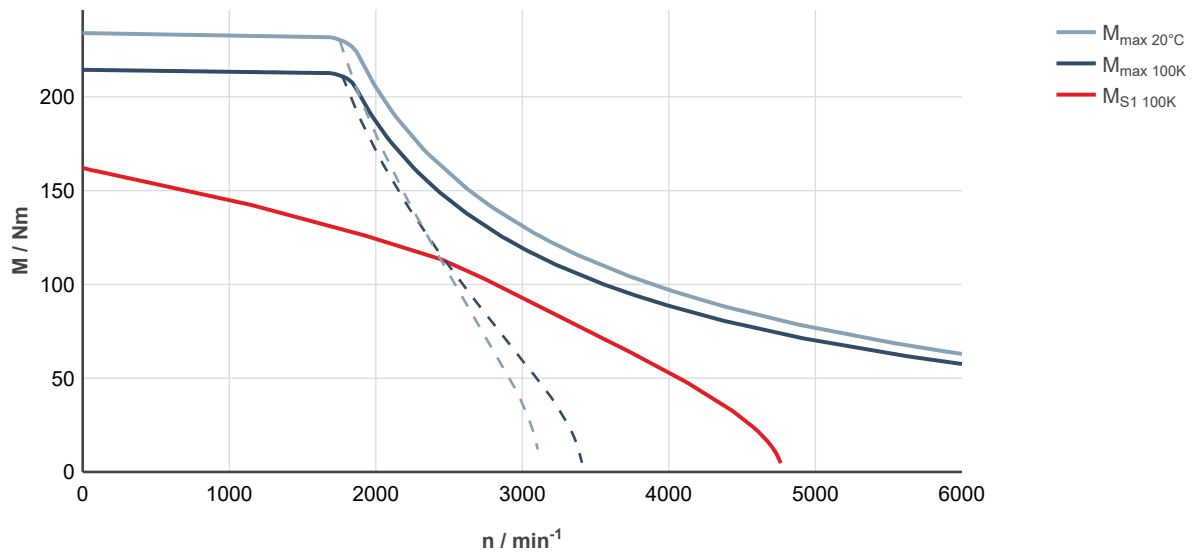

Fig. 276: MS2N10-E0BNL-___0-___-___, ctrlX DRIVE, uncontrolled supply 3 × AC 400 V

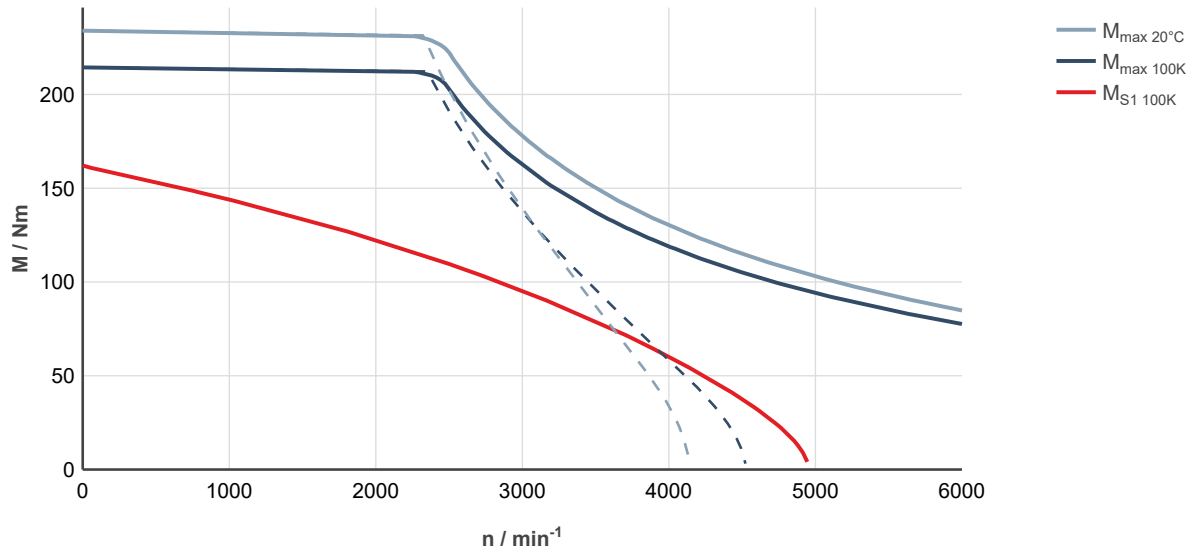

Fig. 277: MS2N10-E0BNL-___0-___-___, ctrlX DRIVE, controlled supply 3 × AC 400 ... 480 V

MS2N10-E1BNL

Designation	Symbol	Unit	MS2N10-E1BNL-__0-N	MS2N10-E1BNL-__3-N
Standstill torque - 100K ¹⁾	$M_{0\ 100K}$	Nm	159	
Standstill current - 100K	$I_{0\ 100K}$	A	88.0	
Moment of inertia of rotor ¹⁾	J_{rot}	kg*m ²	0.025	0.0277
Rated speed - 100K	$n_{N\ 100K}$	1/min	2750	
Rated torque - 100K ¹⁾	$M_{N\ 100K}$	Nm	91.4	
Rated current - 100K	$I_{N\ 100K}$	A	51.5	
Rated power - 100K ¹⁾	$P_{N\ 100K}$	kW	26.3	
Maximum torque 20 °C (cold) ¹⁾	$M_{max\ 20°C}$	Nm	266	
Maximum torque 100K (warm) ¹⁾	$M_{max\ 100K}$	Nm	244	
Maximum current	$I_{max(rms)}$	A	162	
Maximum speed (electrical)	$n_{max\ el}$	1/min	6000	
Maximum speed (mechanical)	$n_{max\ mech}$	1/min	6000	
Number of pole pairs	p		5	
Torque constant at 20 °C ¹⁾	K_m	Nm/A	2.0	
Voltage constant at 20 °C ¹⁾	K_E	V/1000 min ⁻¹	121.6	
Winding resistance at 20 °C	R_{12}	Ohm	0.137	
Winding inductance	L_{12_min}	mH	2.87	
Leakage capacitance of the component	C_{ab}	nF	5.0	
Thermal time constant of winding	T_{th_W}	s	79.5	
Thermal time constant of motor	T_{th_M}	min	5.2	
Mass	m_{mot}	kg	51	58
Holding brake				
Holding torque	M_4	Nm	0	90.00
Rated voltage	U_N	V	0	24
Rated current	I_N	A	0	1.50
Maximum connection time	t_1	ms	0	65
Maximum disconnection time	t_2	ms	0	250
Water cooling				
Power loss	P_V	kW	2.15	
Coolant inlet temperature	T_{in}	°C	10 ... 40	
Permissible coolant temperature increase for P_V	ΔT_{max}	K	8.0	
Required coolant flow for P_V	Q_{min}	l/min	3.86	
Pressure drop at Q_{min}	Δp	bar	0.34	
Maximum permissible inlet pressure	p_{max}	bar	6.0	
Volume of coolant duct	V_{cool}	l	0.35	
Material of coolant duct			Stainless steel	
1) For tolerance details refer to chapter 6.4 Tolerances			Latest amendment: 2019-07-02	

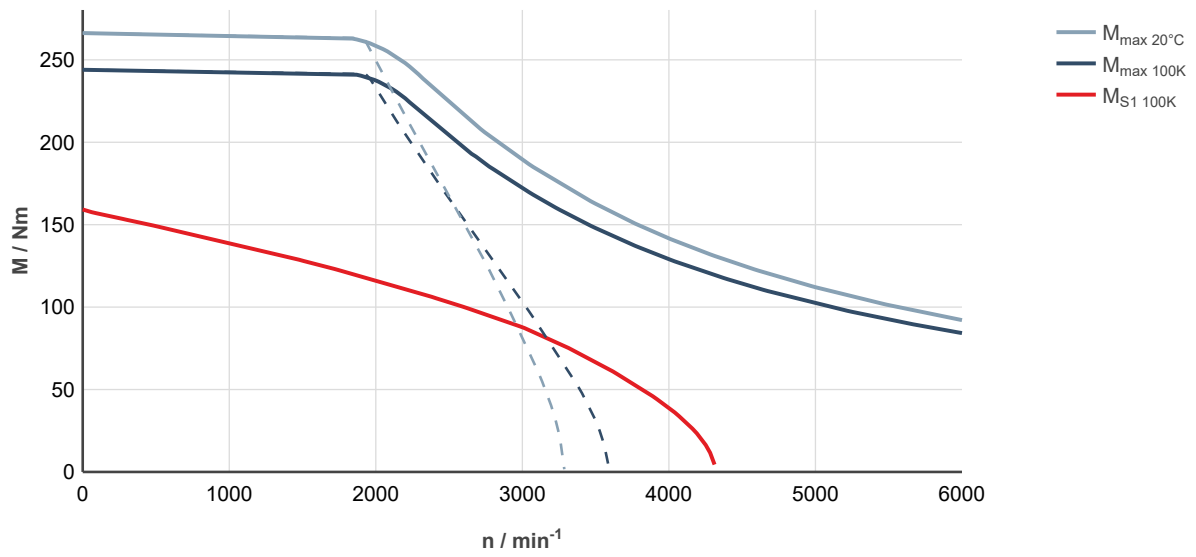

Fig. 278: MS2N10-E1BNL-__0-__-__, ctrlX DRIVE, uncontrolled supply 3 × AC 400 V

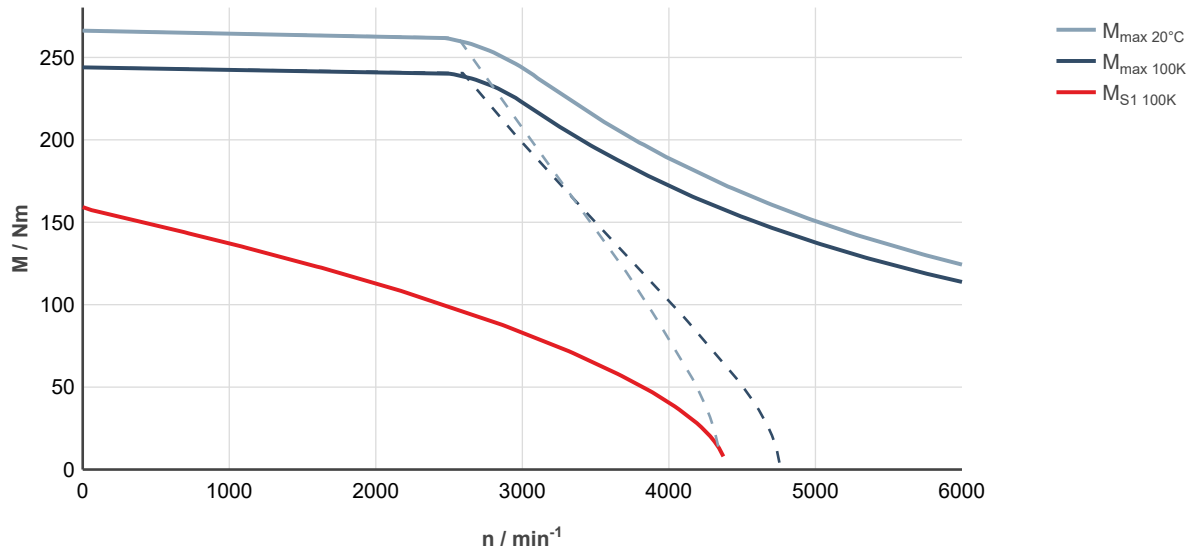

Fig. 279: MS2N10-E1BNL-__0-__-__, ctrlX DRIVE, controlled supply 3 × AC 400 ... 480 V

MS2N10-F0BHL

Designation	Symbol	Unit	MS2N10-F0BHL-__0-_N	MS2N10-F0BHL-__3-_N
Standstill torque - 100K ¹⁾	$M_{0\ 100K}$	Nm	214	
Standstill current - 100K	$I_{0\ 100K}$	A	87.5	
Moment of inertia of rotor ¹⁾	J_{rot}	kg*m ²	0.0147	0.0174
Rated speed - 100K	$n_{N\ 100K}$	1/min	1650	
Rated torque - 100K ¹⁾	$M_{N\ 100K}$	Nm	173	
Rated current - 100K	$I_{N\ 100K}$	A	70.5	
Rated power - 100K ¹⁾	$P_{N\ 100K}$	kW	29.8	
Maximum torque 20 °C (cold) ¹⁾	$M_{max\ 20°C}$	Nm	313	
Maximum torque 100K (warm) ¹⁾	$M_{max\ 100K}$	Nm	287	
Maximum current	$I_{max(rms)}$	A	140	
Maximum speed (electrical)	$n_{max\ el}$	1/min	4000	
Maximum speed (mechanical)	$n_{max\ mech}$	1/min	6000	
Number of pole pairs	p		5	
Torque constant at 20 °C ¹⁾	K_m	Nm/A	2.84	
Voltage constant at 20 °C ¹⁾	K_E	V/1000 min ⁻¹	172.5	
Winding resistance at 20 °C	R_{12}	Ohm	0.169	
Winding inductance	L_{12_min}	mH	5.01	
Leakage capacitance of the component	C_{ab}	nF	8.7	
Thermal time constant of winding	T_{th_W}	s	101.2	
Thermal time constant of motor	T_{th_M}	min	5.3	
Mass	m_{mot}	kg	59	66
Holding brake				
Holding torque	M_4	Nm	0	90.00
Rated voltage	U_N	V	0	24
Rated current	I_N	A	0	1.50
Maximum connection time	t_1	ms	0	65
Maximum disconnection time	t_2	ms	0	250
Water cooling				
Power loss	P_V	kW	2.65	
Coolant inlet temperature	T_{in}	°C	10 ... 40	
Permissible coolant temperature increase for P_V	ΔT_{max}	K	8.0	
Required coolant flow for P_V	Q_{min}	l/min	4.8	
Pressure drop at Q_{min}	Δp	bar	0.51	
Maximum permissible inlet pressure	p_{max}	bar	6.0	
Volume of coolant duct	V_{cool}	l	0.45	
Material of coolant duct			Stainless steel	
1) For tolerance details refer to chapter 6.4 Tolerances			Latest amendment: 2019-07-02	

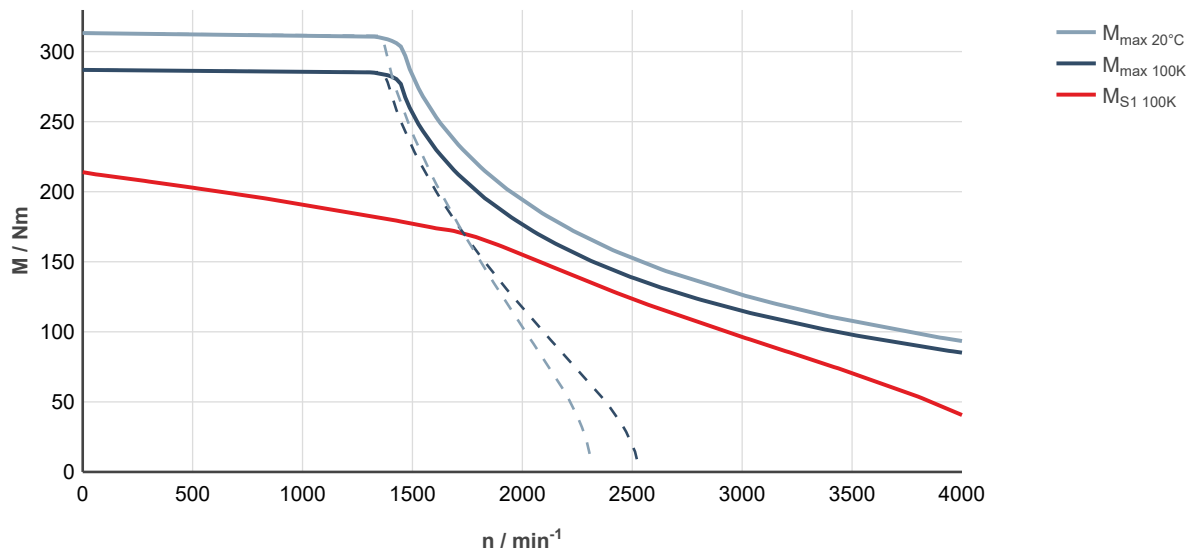

Fig. 280: MS2N10-F0BHL-___0-___-__, ctrlX DRIVE, uncontrolled supply 3 × AC 400 V

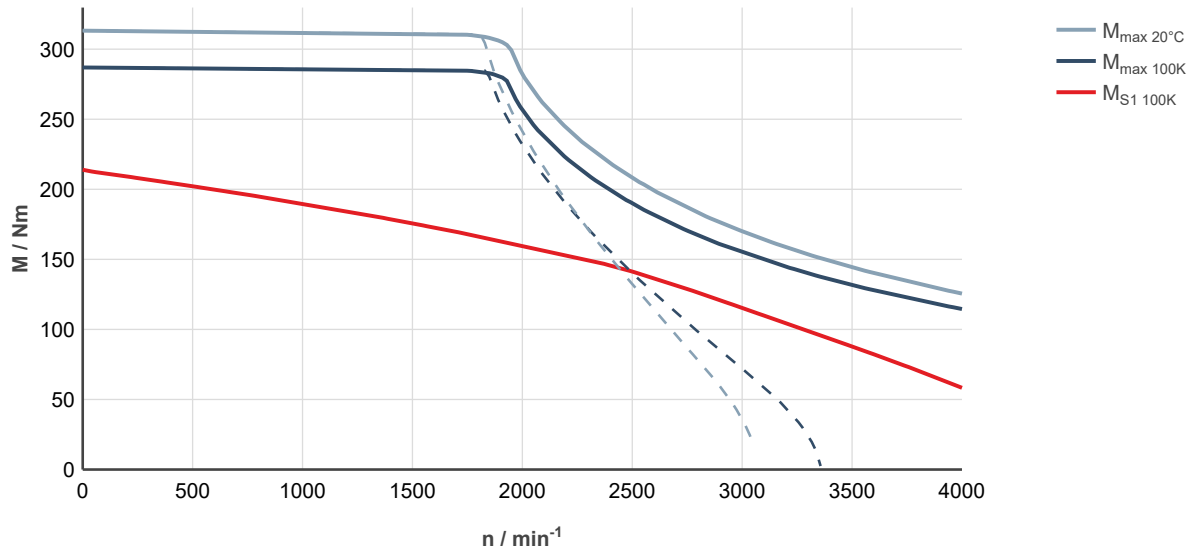

Fig. 281: MS2N10-F0BHL-___0-___-__, ctrlX DRIVE, controlled supply 3 × AC 400 ... 480 V

MS2N10-F1BDL

Designation	Symbol	Unit	MS2N10-F1BDL-__0-N	MS2N10-F1BDL-__3-N
Standstill torque - 100K ¹⁾	$M_{0\ 100K}$	Nm	209	
Standstill current - 100K	$I_{0\ 100K}$	A	42.8	
Moment of inertia of rotor ¹⁾	J_{rot}	kg*m ²	0.0329	0.0356
Rated speed - 100K	$n_{N\ 100K}$	1/min	925	
Rated torque - 100K ¹⁾	$M_{N\ 100K}$	Nm	190	
Rated current - 100K	$I_{N\ 100K}$	A	39.2	
Rated power - 100K ¹⁾	$P_{N\ 100K}$	kW	18.4	
Maximum torque 20 °C (cold) ¹⁾	$M_{max\ 20°C}$	Nm	360	
Maximum torque 100K (warm) ¹⁾	$M_{max\ 100K}$	Nm	330	
Maximum current	$I_{max(rms)}$	A	81.0	
Maximum speed (electrical)	$n_{max\ el}$	1/min	2000	
Maximum speed (mechanical)	$n_{max\ mech}$	1/min	6000	
Number of pole pairs	p		5	
Torque constant at 20 °C ¹⁾	K_m	Nm/A	5.36	
Voltage constant at 20 °C ¹⁾	K_E	V/1000 min ⁻¹	325.5	
Winding resistance at 20 °C	R_{12}	Ohm	0.678	
Winding inductance	L_{12_min}	mH	14.6	
Leakage capacitance of the component	C_{ab}	nF	6.8	
Thermal time constant of winding	T_{th_W}	s	83.0	
Thermal time constant of motor	T_{th_M}	min	5.3	
Mass	m_{mot}	kg	63.0	70
Holding brake				
Holding torque	M_4	Nm	0	90.00
Rated voltage	U_N	V	0	24
Rated current	I_N	A	0	1.50
Maximum connection time	t_1	ms	0	65
Maximum disconnection time	t_2	ms	0	250
Water cooling				
Power loss	P_V	kW	2.65	
Coolant inlet temperature	T_{in}	°C	10 ... 40	
Permissible coolant temperature increase for P_V	ΔT_{max}	K	8.0	
Required coolant flow for P_V	Q_{min}	l/min	4.8	
Pressure drop at Q_{min}	Δp	bar	0.51	
Maximum permissible inlet pressure	p_{max}	bar	6.0	
Volume of coolant duct	V_{cool}	l	0.45	
Material of coolant duct			Stainless steel	
1) For tolerance details refer to chapter 6.4 Tolerances			Latest amendment: 2019-07-02	

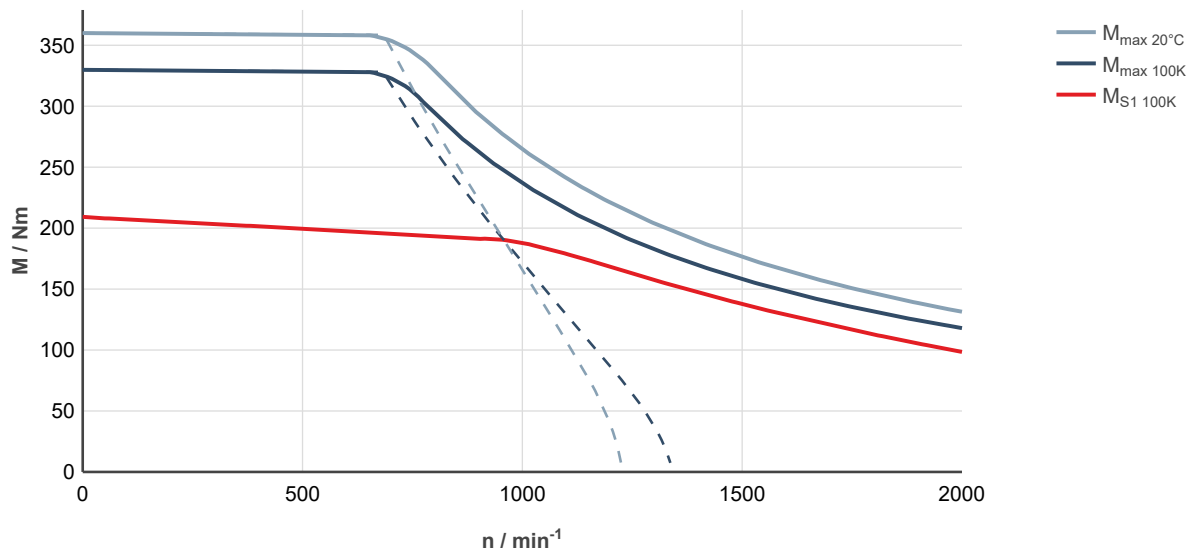

Fig. 282: MS2N10-F1BDL-___0-___-__, ctrlX DRIVE, uncontrolled supply 3 × AC 400 V

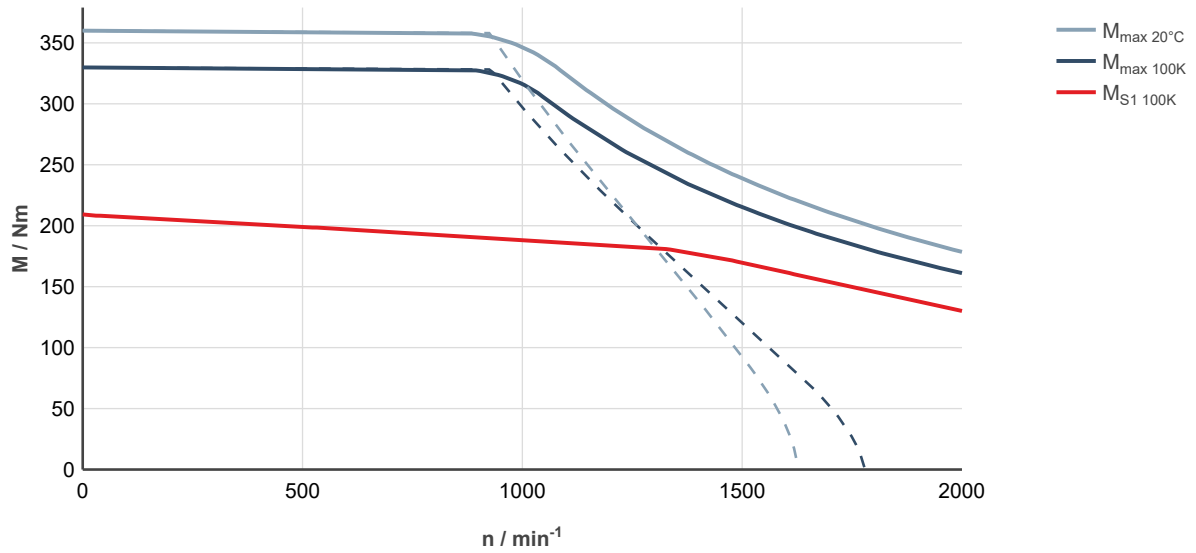

Fig. 283: MS2N10-F1BDL-___0-___-__, ctrlX DRIVE, controlled supply 3 × AC 400 ... 480 V

MS2N10-F1BHL

Designation	Symbol	Unit	MS2N10-F1BHL-__0-_N	MS2N10-F1BHL-__3-_N
Standstill torque - 100K ¹⁾	$M_{0\ 100K}$	Nm	209	
Standstill current - 100K	$I_{0\ 100K}$	A	86.0	
Moment of inertia of rotor ¹⁾	J_{rot}	kg*m ²	0.0329	0.0356
Rated speed - 100K	$n_{N\ 100K}$	1/min	1930	
Rated torque - 100K ¹⁾	$M_{N\ 100K}$	Nm	157	
Rated current - 100K	$I_{N\ 100K}$	A	65.7	
Rated power - 100K ¹⁾	$P_{N\ 100K}$	kW	31.7	
Maximum torque 20 °C (cold) ¹⁾	$M_{max\ 20°C}$	Nm	360	
Maximum torque 100K (warm) ¹⁾	$M_{max\ 100K}$	Nm	330	
Maximum current	$I_{max(rms)}$	A	162	
Maximum speed (electrical)	$n_{max\ el}$	1/min	4000	
Maximum speed (mechanical)	$n_{max\ mech}$	1/min	6000	
Number of pole pairs	p		5	
Torque constant at 20 °C ¹⁾	K_m	Nm/A	2.7	
Voltage constant at 20 °C ¹⁾	K_E	V/1000 min ⁻¹	163.9	
Winding resistance at 20 °C	R_{12}	Ohm	0.174	
Winding inductance	L_{12_min}	mH	3.61	
Leakage capacitance of the component	C_{ab}	nF	6.70	
Thermal time constant of winding	T_{th_W}	s	83.0	
Thermal time constant of motor	T_{th_M}	min	5.3	
Mass	m_{mot}	kg	63.0	70
Holding brake				
Holding torque	M_4	Nm	0	90.00
Rated voltage	U_N	V	0	24
Rated current	I_N	A	0	1.50
Maximum connection time	t_1	ms	0	65
Maximum disconnection time	t_2	ms	0	250
Water cooling				
Power loss	P_V	kW	2.65	
Coolant inlet temperature	T_{in}	°C	10 ... 40	
Permissible coolant temperature increase for P_V	ΔT_{max}	K	8.0	
Required coolant flow for P_V	Q_{min}	l/min	4.8	
Pressure drop at Q_{min}	Δp	bar	0.51	
Maximum permissible inlet pressure	p_{max}	bar	6.0	
Volume of coolant duct	V_{cool}	l	0.45	
Material of coolant duct			Stainless steel	
1) For tolerance details refer to chapter 6.4 Tolerances			Latest amendment: 2019-07-02	

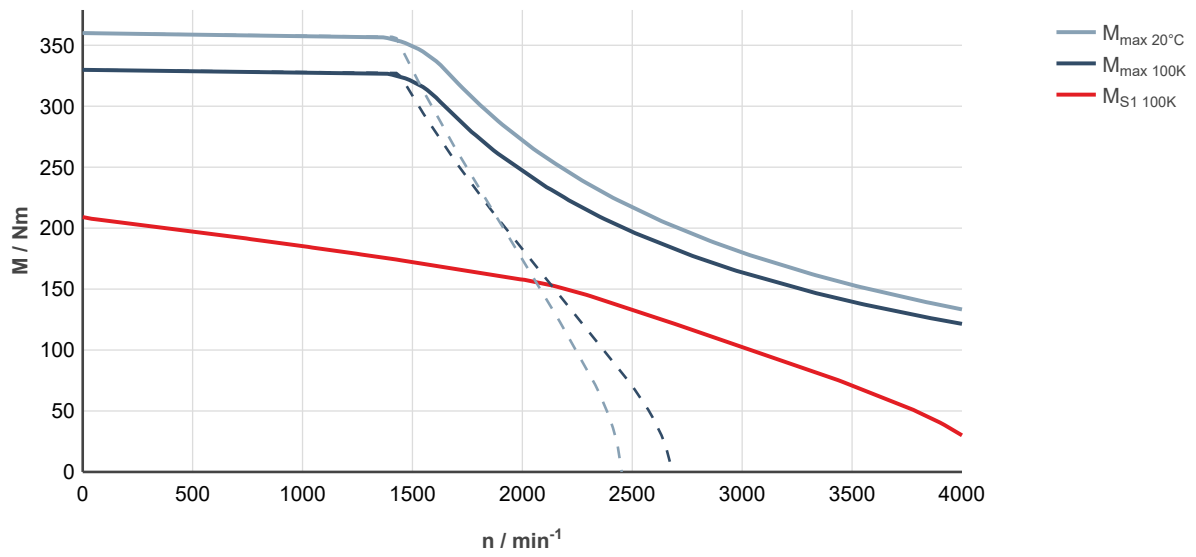

Fig. 284: MS2N10-F1BHL-___0-___-__, ctrlX DRIVE, uncontrolled supply 3 × AC 400 V

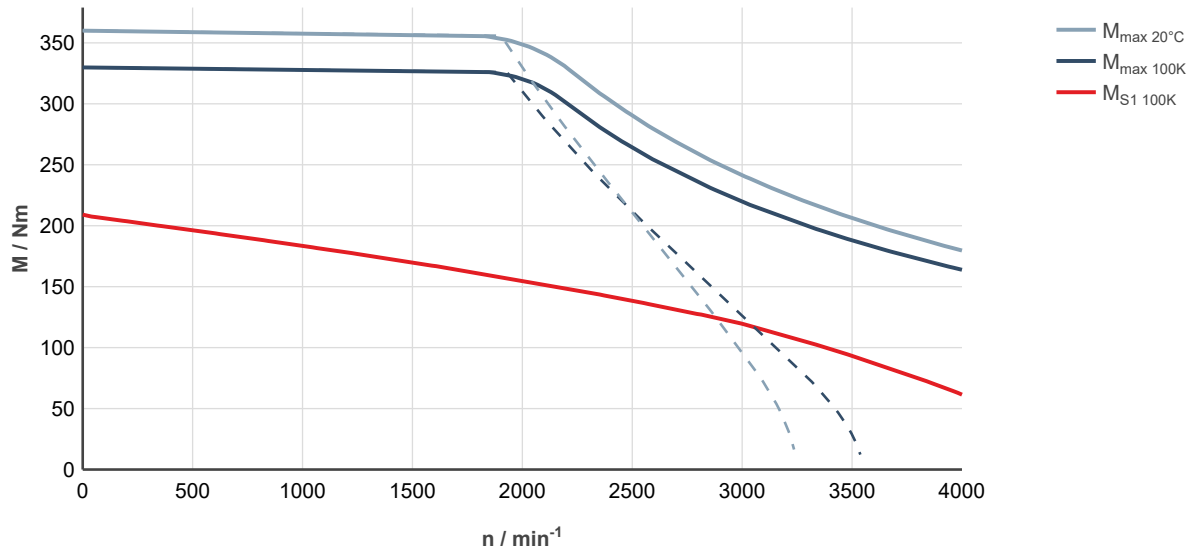

Fig. 285: MS2N10-F1BHL-___0-___-__, ctrlX DRIVE, controlled supply 3 × AC 400 ... 480 V

MS2N10-R0BLL

Designation	Symbol	Unit	MS2N10-R0BLL-__0-_N	MS2N10-R0BLL-__3-_N
Standstill torque - 100K ¹⁾	M _{0 100K}	Nm	186	
Standstill current - 100K	I _{0 100K}	A	96.2	
Moment of inertia of rotor ¹⁾	J _{rot}	kg*m ²	0.0147	0.0174
Rated speed - 100K	n _{N 100K}	1/min	2,500	
Rated torque - 100K ¹⁾	M _{N 100K}	Nm	134	
Rated current - 100K	I _{N 100K}	A	71.4	
Rated power - 100K ¹⁾	P _{N 100K}	kW	35.1	
Maximum torque 20 °C (cold) ¹⁾	M _{max 20°C}	Nm	355	
Maximum torque 100K (warm) ¹⁾	M _{max 100K}	Nm	325	
Maximum current	I _{max(eff)}	A	220	
Maximum speed (electrical)	n _{max el}	1/min	5,000	
Maximum speed (mechanical)	n _{max mech}	1/min	6,000	
Number of pole pairs	p		5	
Torque constant at 20 °C ¹⁾	K _m	Nm/A	2.0	
Voltage constant at 20 °C ¹⁾	K _E	V/1000 min ⁻¹	122.7	
Winding resistance at 20 °C	R ₁₂	Ohm	0.113	
Winding inductance	L _{12,min}	mH	2.30	
Leakage capacitance of the component	C _{ab}	nF	13.5	
Thermal time constant of winding	T _{th,W}	s	97.5	
Thermal time constant of motor	T _{th,M}	min	5.2	
Mass	m _{mot}	kg	58.0	68.8
Holding brake				
Holding torque	M ₄	Nm	0	90.00
Rated voltage	U _N	V	0	24
Rated current	I _N	A	0	1.50
Maximum connection time	t ₁	ms	0	65
Maximum disconnection time	t ₂	ms	0	250
Water cooling				
Power loss	P _V	kW	3.30	
Coolant inlet temperature	T _{in}	°C	10 ... 40	
Permissible coolant temperature increase for P _V	ΔT _{max}	K	8.0	
Required coolant flow for P _V	Q _{min}	l/min	6.0	
Pressure drop at Q _{min}	Δp	bar	0.80	
Maximum permissible inlet pressure	p _{max}	bar	6.0	
Volume of coolant duct	V _{cool}	l	0.45	
Material of coolant duct			Stainless steel	
1) For tolerance details refer to chapter 6.4 Tolerances			Latest amendment: 2022-05-04	

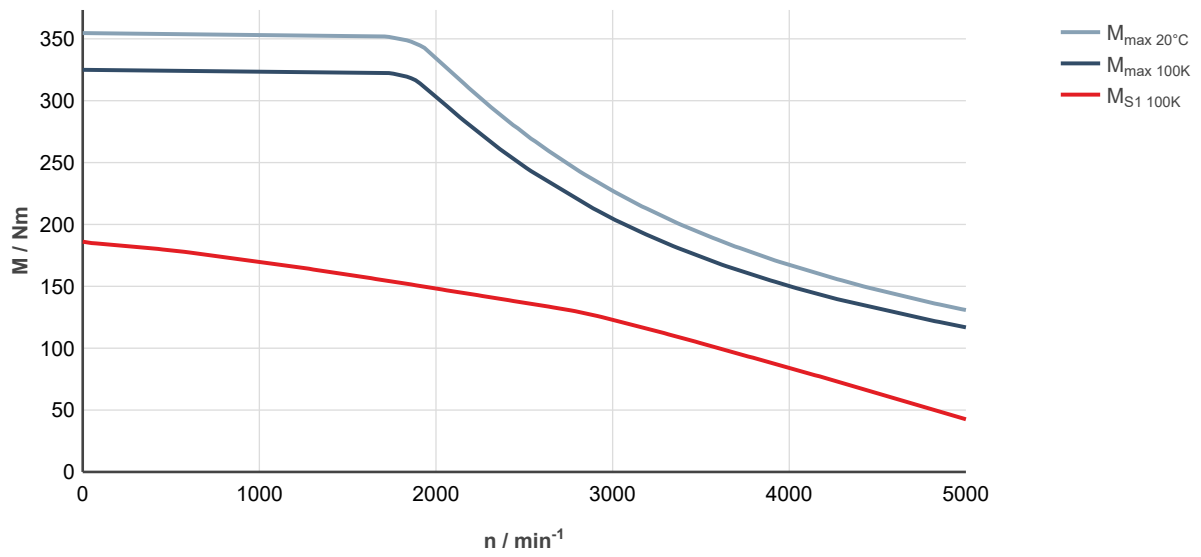

Fig. 286: MS2N10-R0BLL-__0-__-__, ctrlX DRIVE, uncontrolled supply 3 × AC 400 V

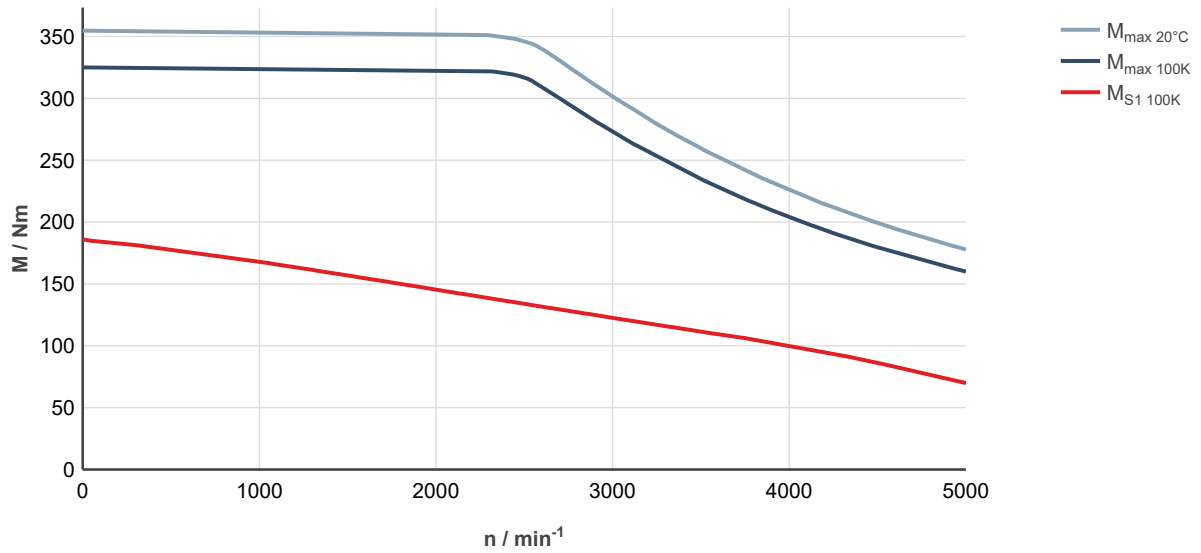

Fig. 287: MS2N10-R0BLL-__0-__-__, ctrlX DRIVE, controlled supply 3 x AC 400 ... 480 V

MS2N10-R0BQL

Designation	Symbol	Unit	MS2N10-R0BQL-__0-_N	MS2N10-R0BQL-__3-_N
Standstill torque - 100K ¹⁾	$M_{0\ 100K}$	Nm	186.0	
Standstill current - 100K	$I_{0\ 100K}$	A	143	
Moment of inertia of rotor ¹⁾	J_{rot}	kg*m ²	0.0147	0.0174
Rated speed - 100K	$n_{N\ 100K}$	1/min	4,000	
Rated torque - 100K ¹⁾	$M_{N\ 100K}$	Nm	89.3	
Rated current - 100K	$I_{N\ 100K}$	A	73.4	
Rated power - 100K ¹⁾	$P_{N\ 100K}$	kW	37.4	
Maximum torque 20 °C (cold) ¹⁾	$M_{max\ 20°C}$	Nm	355	
Maximum torque 100K (warm) ¹⁾	$M_{max\ 100K}$	Nm	325	
Maximum current	$I_{max(eff)}$	A	330	
Maximum speed (electrical)	$n_{max\ el}$	1/min	6,000	
Maximum speed (mechanical)	$n_{max\ mech}$	1/min	6,000	
Number of pole pairs	p		5	
Torque constant at 20 °C ¹⁾	K_m	Nm/A	1.37	
Voltage constant at 20 °C ¹⁾	K_E	V/1000 min ⁻¹	81.8	
Winding resistance at 20 °C	R_{12}	Ohm	0.05	
Winding inductance	$L_{12,min}$	mH	0.765	
Leakage capacitance of the component	C_{ab}	nF	13.5	
Thermal time constant of winding	$T_{th,W}$	s	97.5	
Thermal time constant of motor	$T_{th,M}$	min	5.2	
Mass	m_{mot}	kg	58.0	68.8
Holding brake				
Holding torque	M_4	Nm	0	90.00
Rated voltage	U_N	V	0	24
Rated current	I_N	A	0	1.50
Maximum connection time	t_1	ms	0	65
Maximum disconnection time	t_2	ms	0	250
Water cooling				
Power loss	P_V	kW	2.90	
Coolant inlet temperature	T_{in}	°C	10 ... 40	
Permissible coolant temperature increase for P_V	ΔT_{max}	K	8.0	
Required coolant flow for P_V	Q_{min}	l/min	5.3	
Pressure drop at Q_{min}	Δp	bar	0.65	
Maximum permissible inlet pressure	p_{max}	bar	6.0	
Volume of coolant duct	V_{cool}	l	0.45	
Material of coolant duct			Stainless steel	
1) For tolerance details refer to chapter 6.4 Tolerances			Latest amendment: 2022-05-04	

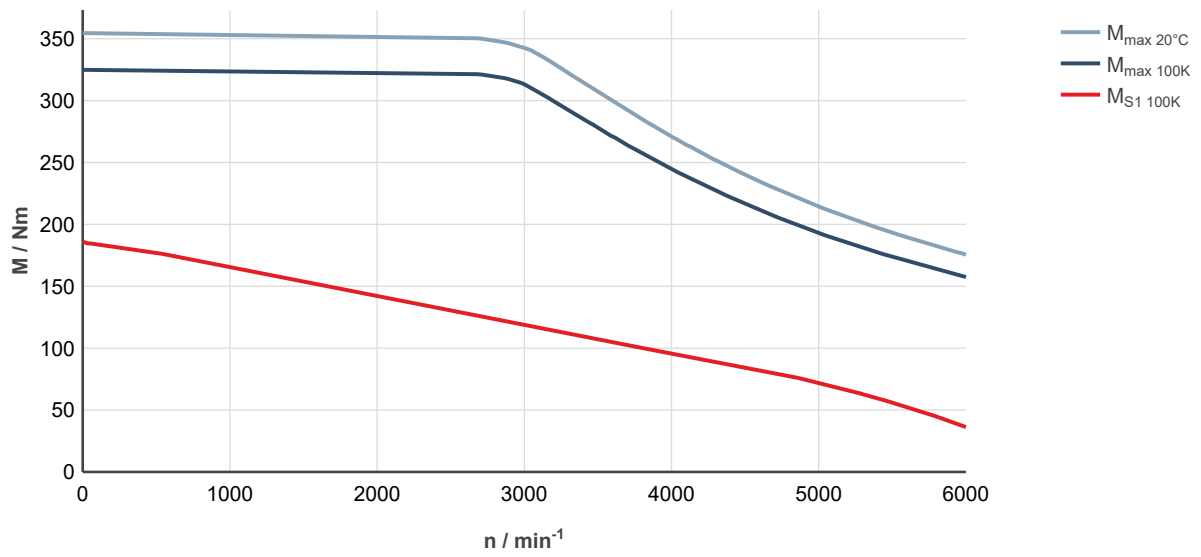

Fig. 288: MS2N10-R0BQL-__0-__-__, ctrlX DRIVE, uncontrolled supply 3 × AC 400 V

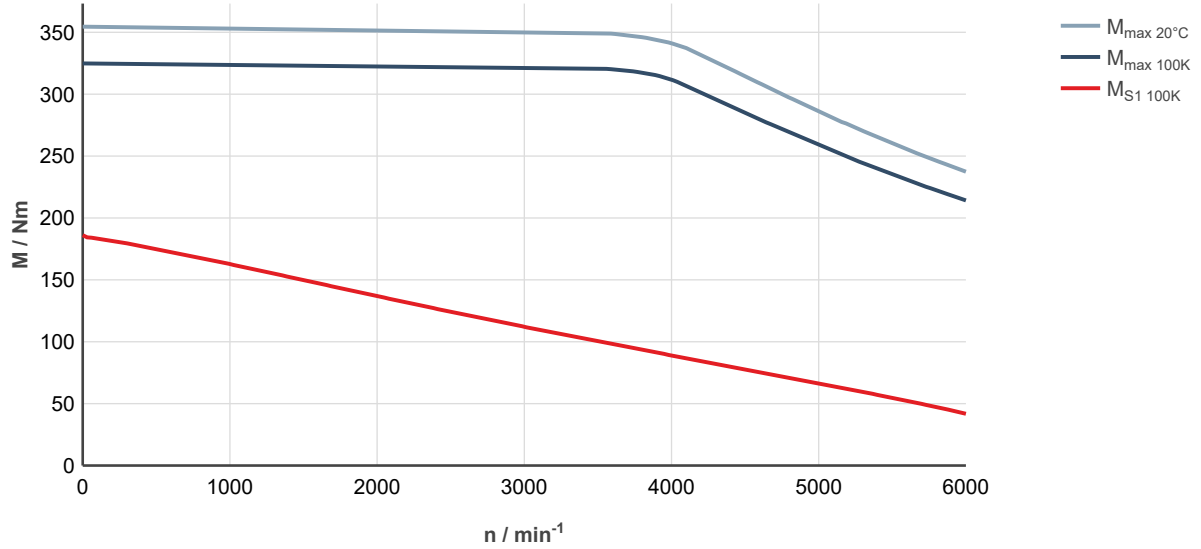

Fig. 289: MS2N10-R0BQL-__0-__-__, ctrlX DRIVE, controlled supply 3 x AC 400 ... 480 V

7.6.4 Self-cooling specification with connector

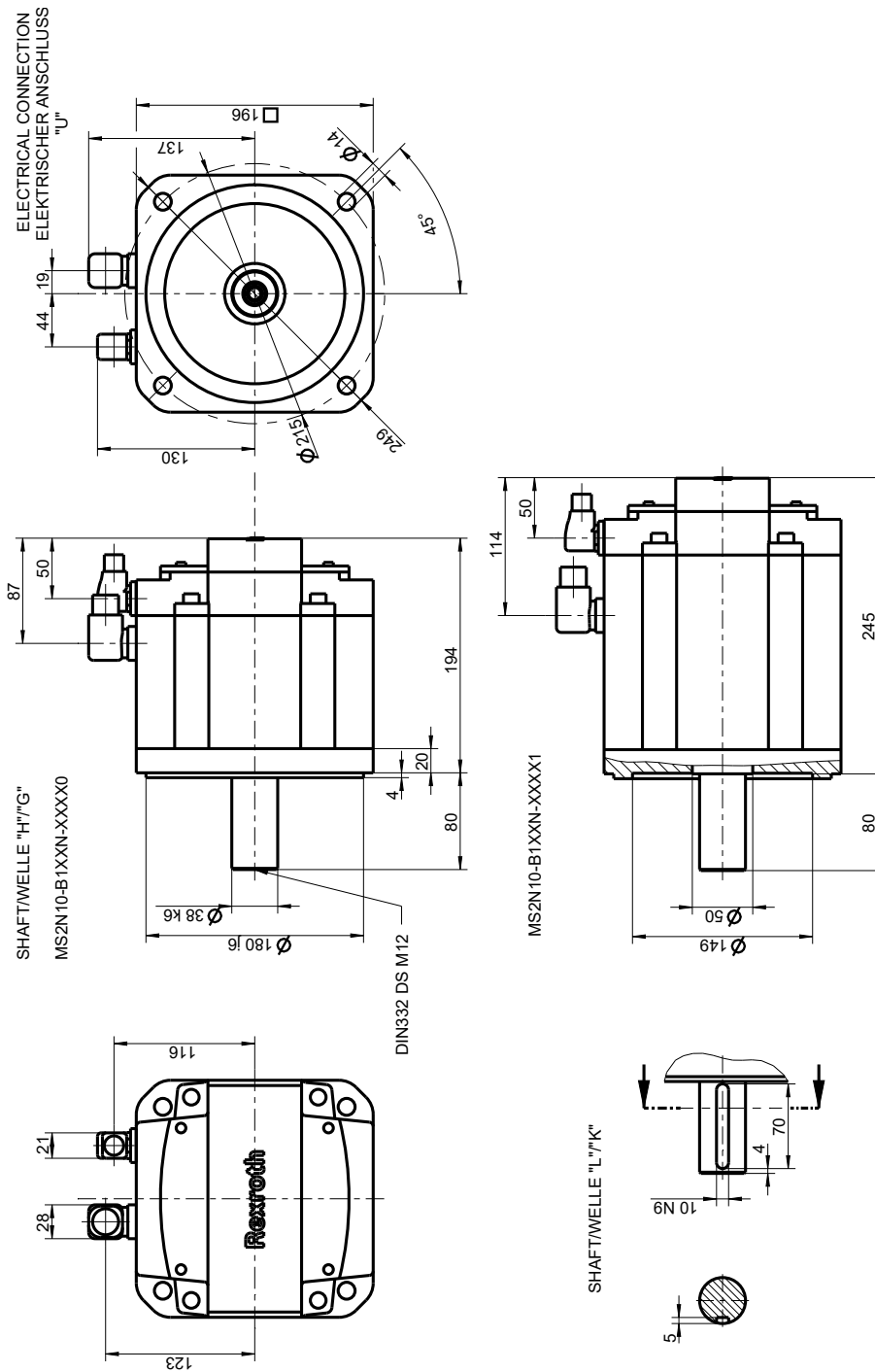
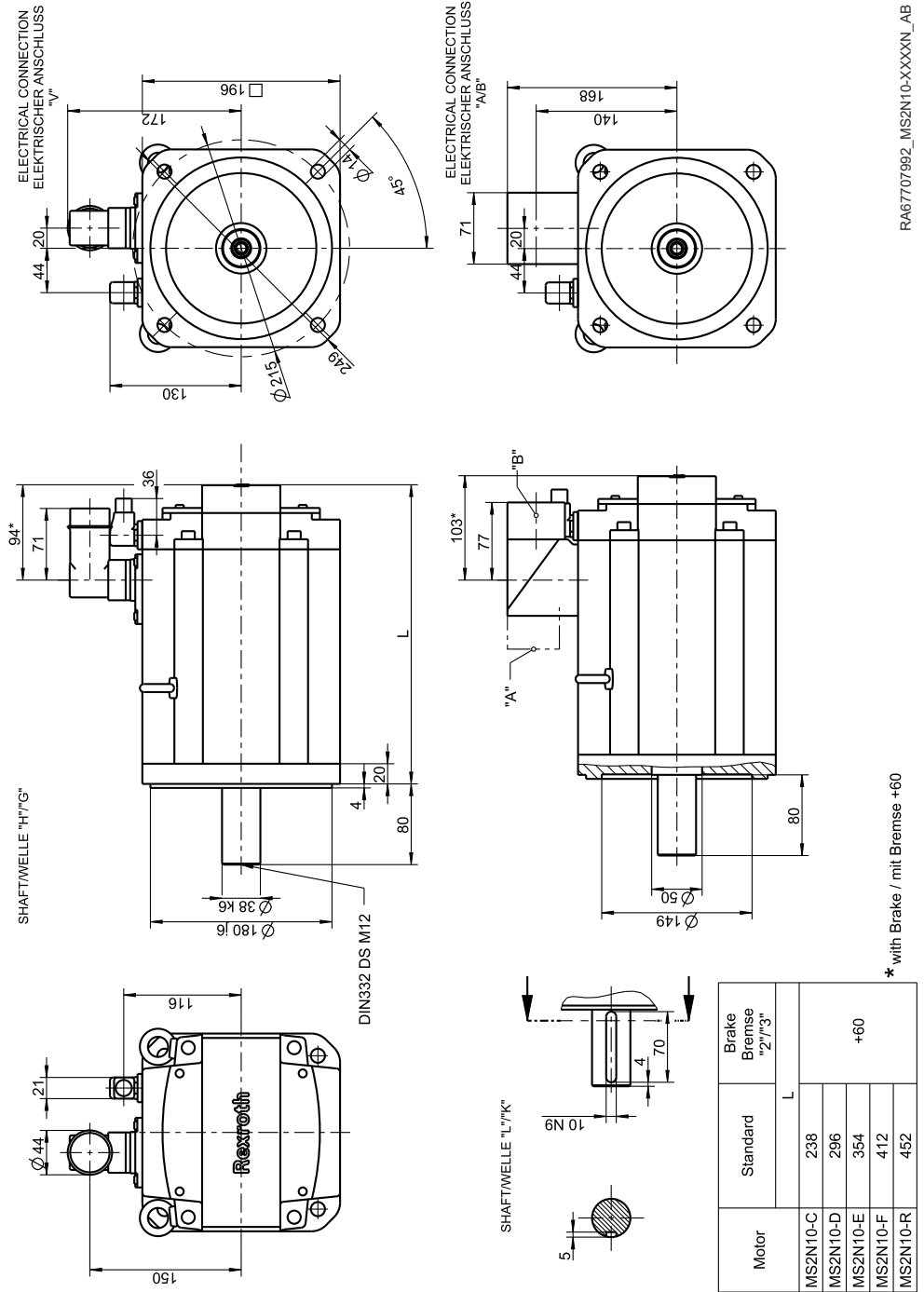

Fig. 290: MS2N10-B1XXN

RA67701070_MS2N10-B1XXN_AA



RA67707992_MS2N10-XXXXN_AB

Fig. 291: MS2N10-XXXXN

7.6.5 Forced ventilation specification with terminal boxes

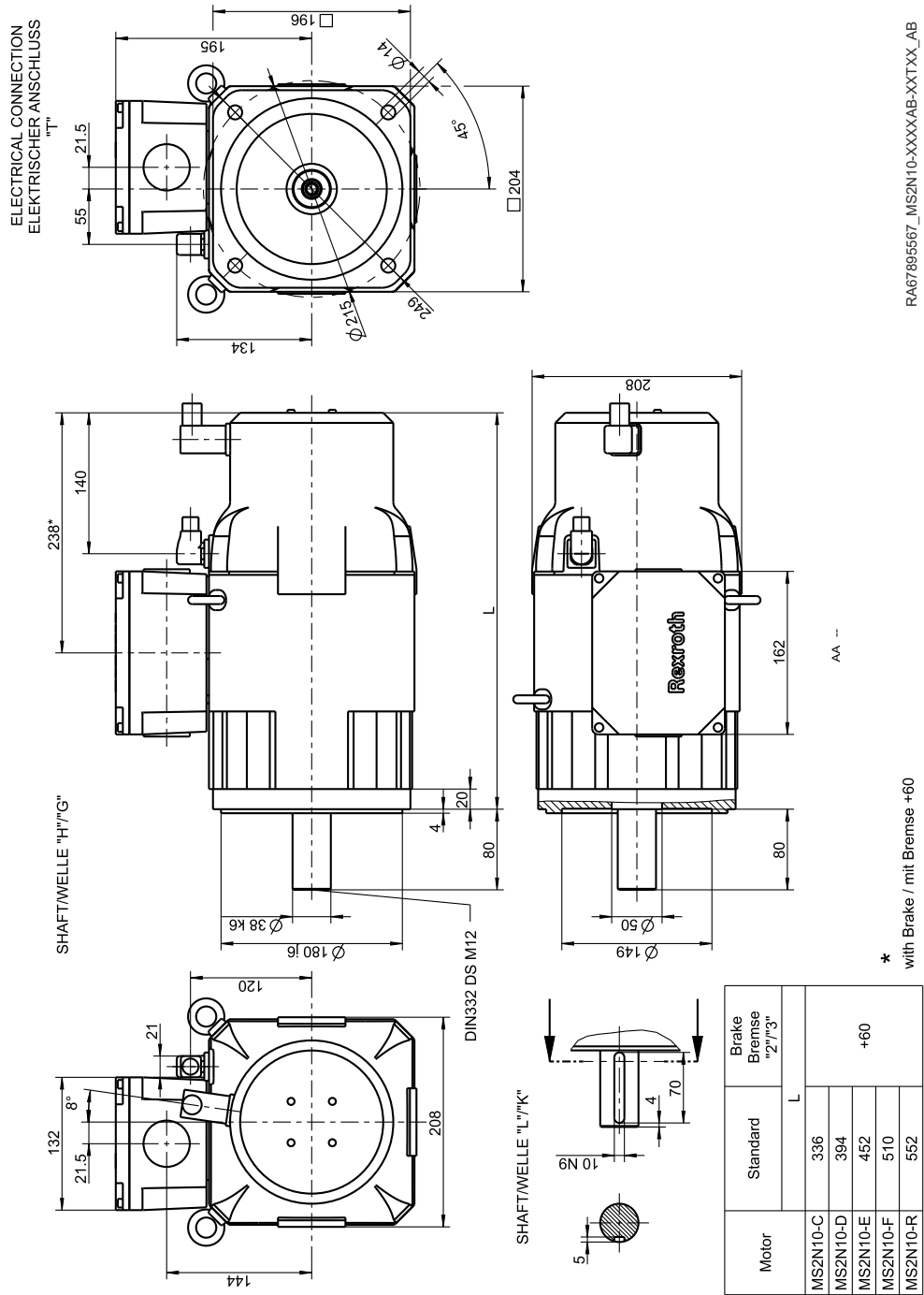

Fig. 292: MS2N10-XXXXAB-XXTXX_AB

7.6.6 Specification forced ventilation with connector

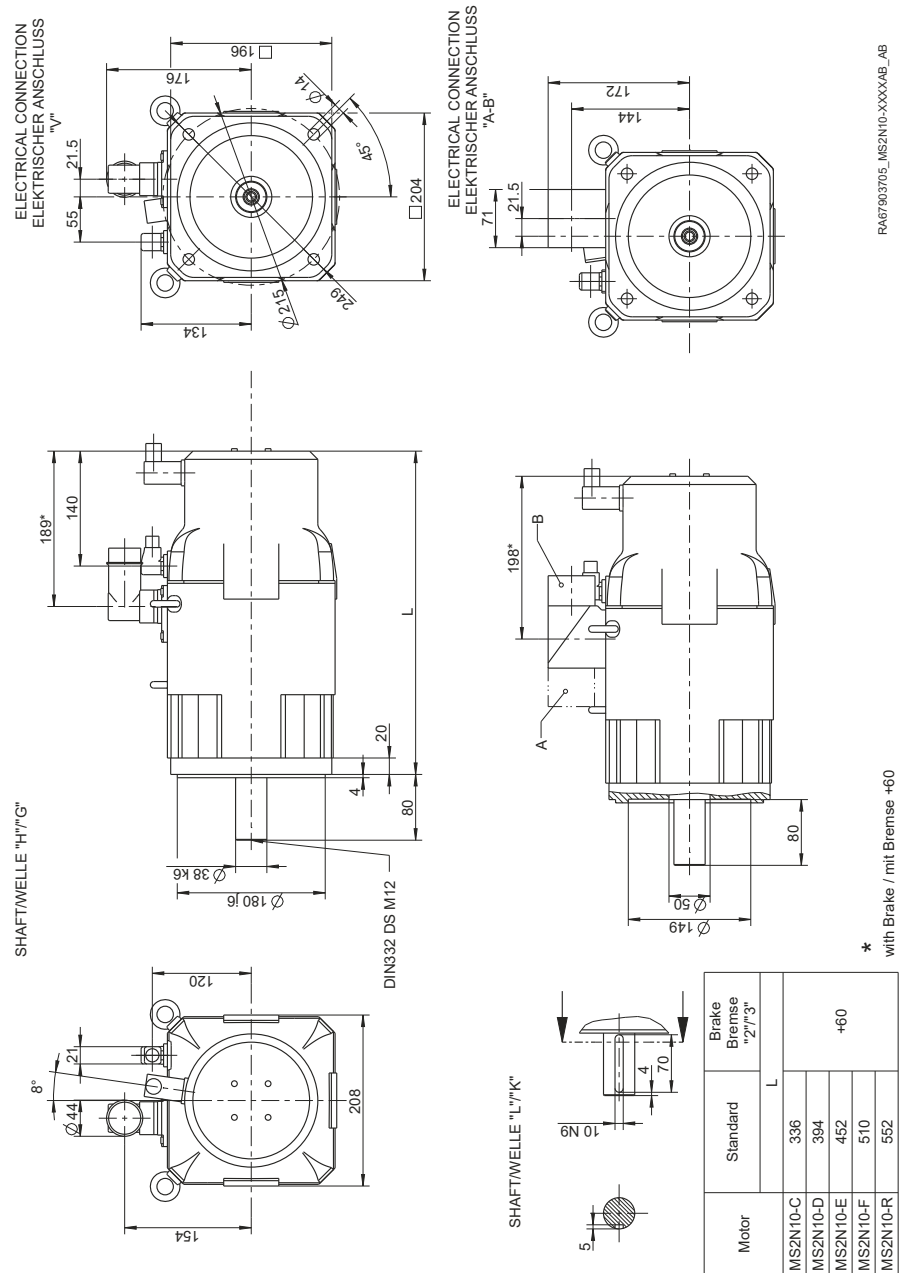

Fig. 293: MS2N10-XXXXA/B_

7.6.7 Water cooling with terminal boxes "C" specification

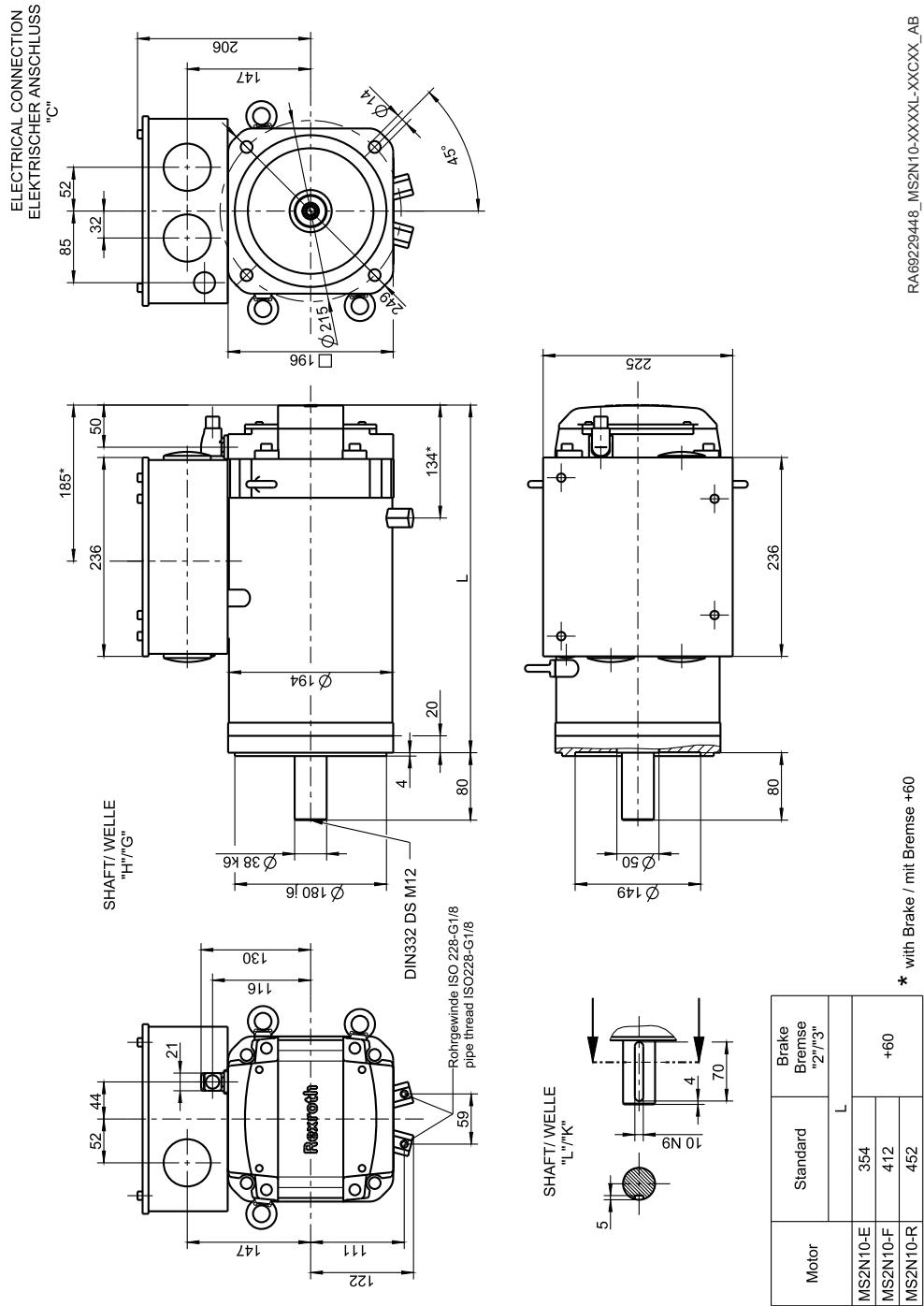

Fig. 294: MS2N10-XXXXL-XXCXX_AB

7.6.8 Water cooling with connectors "A, B" or terminal box "T" specification

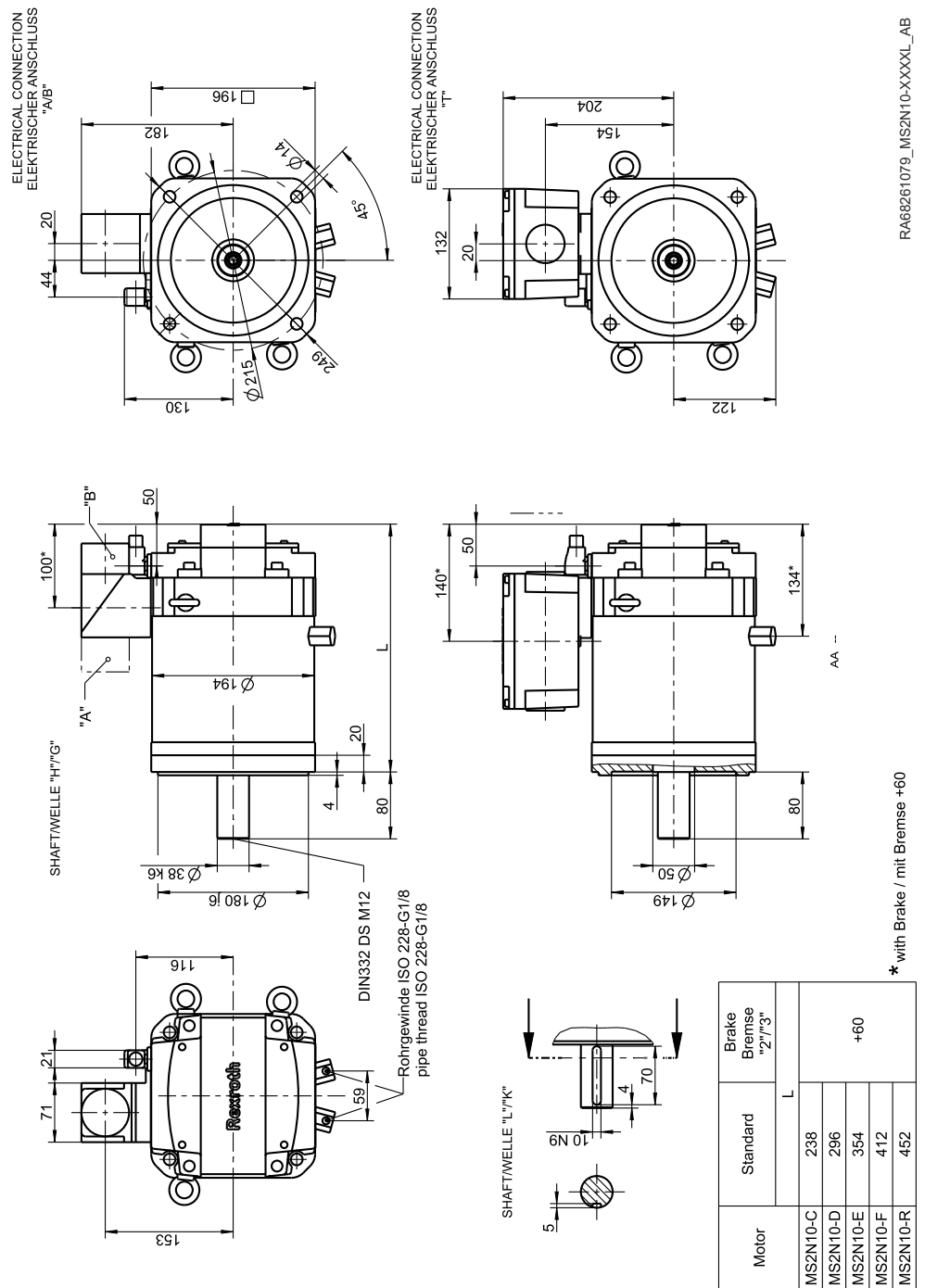
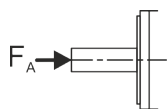

Fig. 295: MS2N10-XXXXL_AB

7.6.9 MS2N10 Axial force



Axial forces F_A are permissible without limitation up to 80 N. Higher axial forces only after a detailed dimensioning by your distribution partner at Bosch Rexroth. For evaluation purposes, please specify the following information:

- Axial and radial force with force application point
- Installation position (horizontal, vertical with the shaft end pointing to the top or bottom)
- Mean speed

7.6.10 MS2N10 Radial force

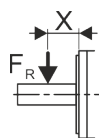

The permissible radial force F_R is specified in distance x from the shaft shoulder, depending on the mean speed in the following diagram.

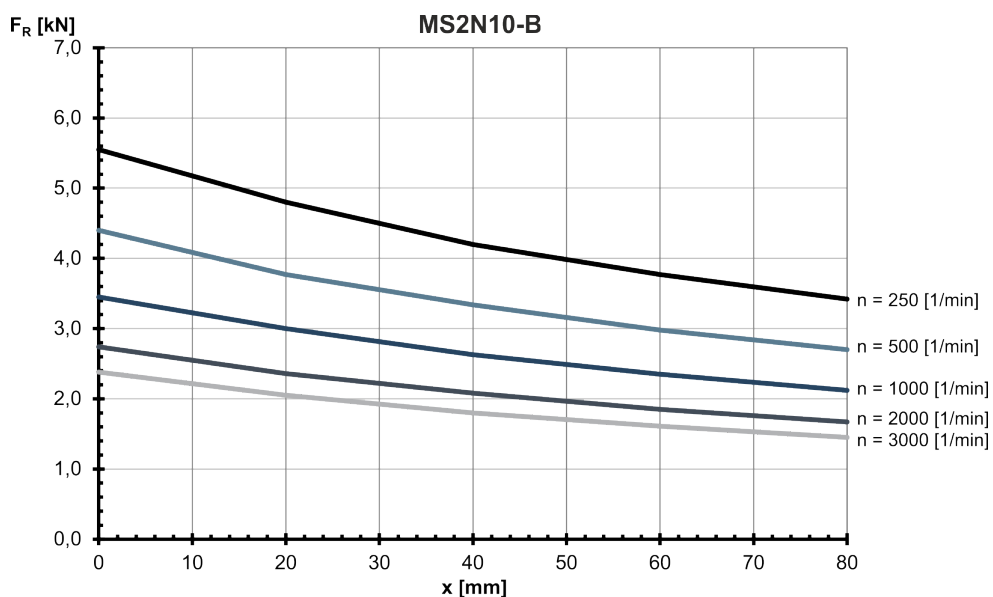

Fig. 296: MS2N10-B: Radial force in distance x from the shaft shoulder at a nominal bearing service life of $L_{h10} = 30000$ h

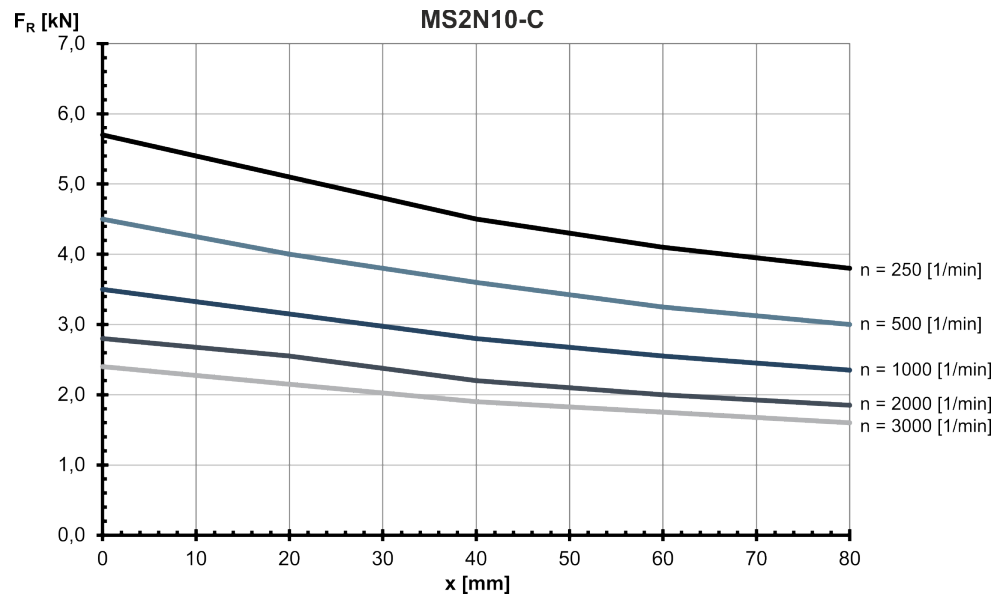

Fig. 297: MS2N10-C: Radial force in distance x from the shaft shoulder at a nominal bearing service life of $L_{h10} = 30000$ h

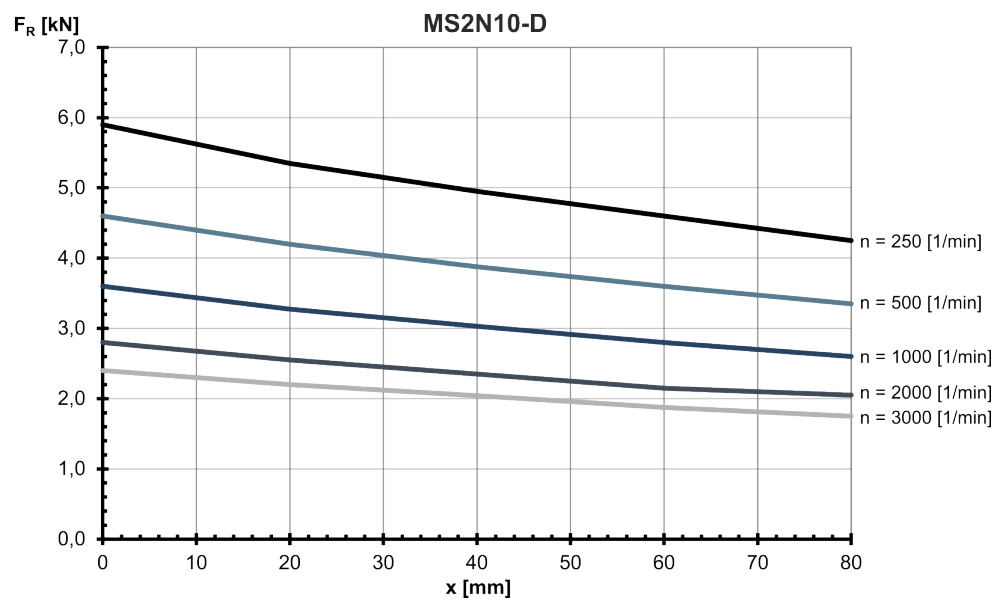

Fig. 298: MS2N10-D: Radial force in distance x from the shaft shoulder at a nominal bearing service life of $L_{h10} = 30000$ h

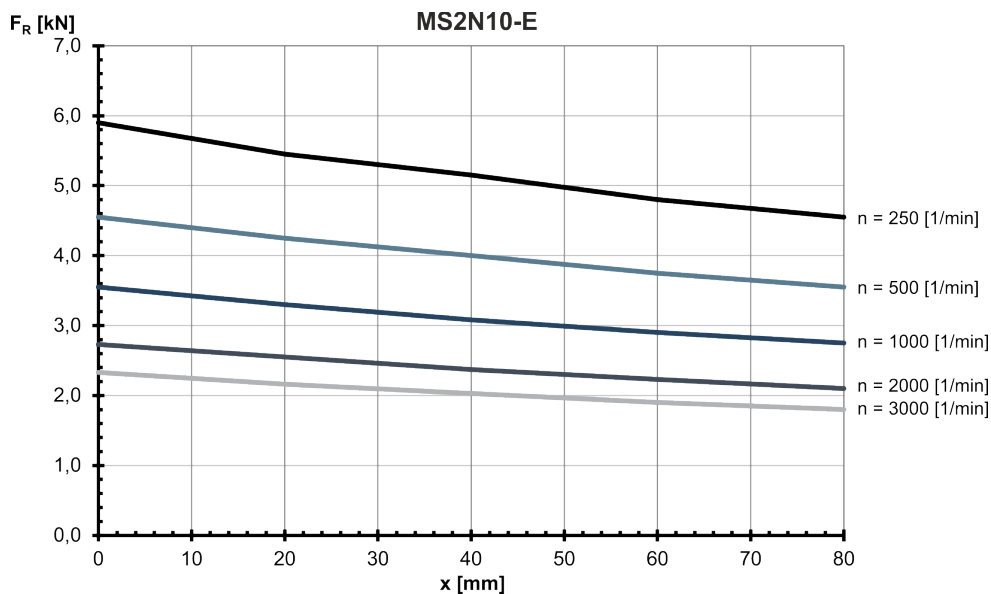

Fig. 299: MS2N10-E: Radial force in distance x from the shaft shoulder at a nominal bearing service life of $L_{h10} = 30000$ h

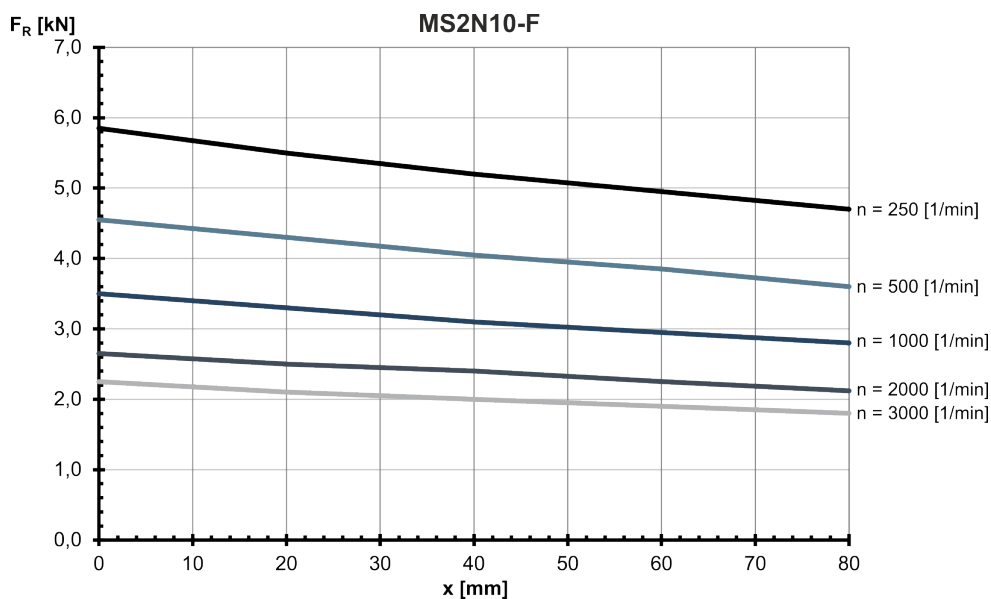

Fig. 300: MS2N10-F: Radial force in distance x from the shaft shoulder at a nominal bearing service life of $L_{h10} = 30000$ h

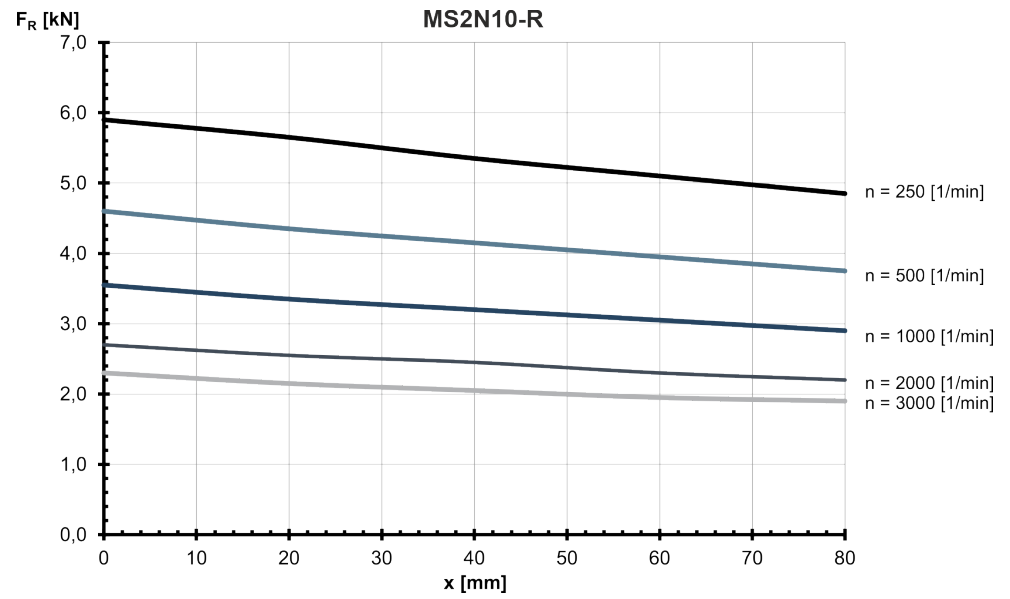

Fig. 301: MS2N10-R: Radial force in distance x from the shaft shoulder at a nominal bearing service life of $L_{h10} = 30000$ h

7.7 MS2N13 Technical data

7.7.1 Self-cooling

MS2N13-B1BHN

Designation	Symbol	Unit	MS2N13-B1BHN-__0-_N	MS2N13-B1BHN-__1-_N
Standstill torque - 60K ¹⁾	M _{0 60K}	Nm	92.5	
Standstill current - 60K	I _{0 60K}	A	36.5	
Standstill torque - 100K ¹⁾	M _{0 100K}	Nm	98.0	
Standstill current - 100K	I _{0 100K}	A	38.7	
Moment of inertia of rotor ¹⁾	J _{rot}	kg*m ²	0.0476	0.055
Rated speed - 100K	n _{N 100K}	1/min	2,000	
Rated torque - 100K ¹⁾	M _{N 100K}	Nm	50.5	
Rated current - 100K	I _{N 100K}	A	20.8	
Rated power - 100K ¹⁾	P _{N 100K}	kW	10.6	
Maximum torque 20 °C (cold) ¹⁾	M _{max 20°C}	Nm	345	
Maximum torque 100K (warm) ¹⁾	M _{max 100K}	Nm	328	
Maximum current	I _{max(eff)}	A	160	
Maximum speed (electrical)	n _{max el}	1/min	3600	
Maximum speed (mechanical)	n _{max mech}	1/min	3600	
Number of pole pairs	p		3	
Torque constant at 20 °C ¹⁾	K _m	Nm/A	2.52	
Voltage constant at 20 °C ¹⁾	K _E	V/1000 min ⁻¹	154	
Winding resistance at 20 °C	R ₁₂	Ohm	0.145	
Winding inductance	L _{12,min}	mH	5.6	
Leakage capacitance of the component	C _{ab}	nF	11.3	
Thermal time constant of winding	T _{th,W}	s	350	
Thermal time constant of motor	T _{th,M}	min	60	
Mass	m _{mot}	kg	89	95
Holding brake				
Holding torque	M ₄	Nm	0	115.00
Rated voltage	U _N	V	0	24
Rated current	I _N	A	0	2.10
Maximum connection time	t ₁	ms	0	100
Maximum disconnection time	t ₂	ms	0	240
1) For tolerance details refer to chapter 6.4 Tolerances			Latest amendment: 2022-02-03	

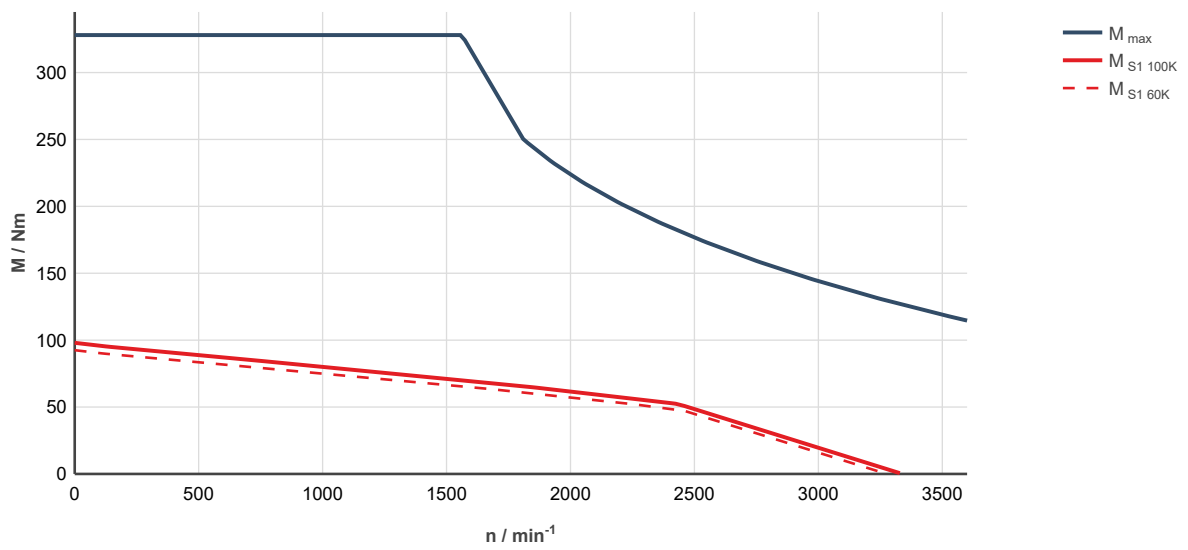

Fig. 302: MS2N13-B1BHN-___0-___-__ (modified), ctrlX DRIVE, uncontrolled supply 3 × AC 400 V

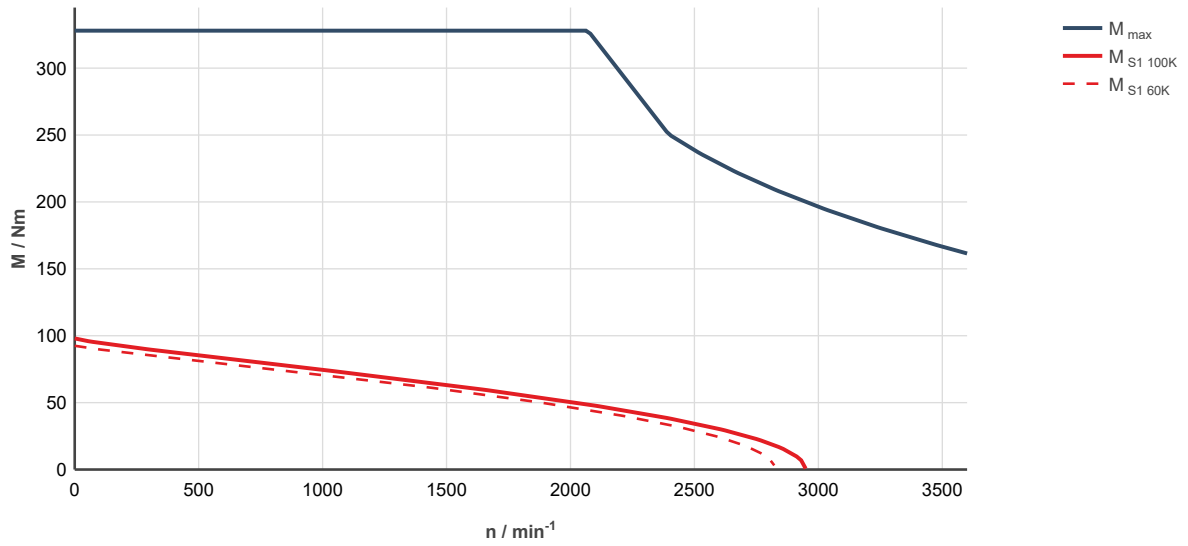

Fig. 303: MS2N13-B1BHN-___0-___-__ (modified), ctrlX DRIVE, controlled supply 3 x AC 400 br ... 480 V

MS2N13-B1BNN

Designation	Symbol	Unit	MS2N13-B1BNN-__0-_N	MS2N13-B1BNN-__1-_N
Standstill torque - 60K ¹⁾	M _{0 60K}	Nm	92.5	
Standstill current - 60K	I _{0 60K}	A	50.7	
Standstill torque - 100K ¹⁾	M _{0 100K}	Nm	98.0	
Standstill current - 100K	I _{0 100K}	A	53.6	
Moment of inertia of rotor ¹⁾	J _{rot}	kg*m ²	0.0476	0.055
Rated speed - 100K	n _{N 100K}	1/min	2,000	
Rated torque - 100K ¹⁾	M _{N 100K}	Nm	33.6	
Rated current - 100K	I _{N 100K}	A	19.7	
Rated power - 100K ¹⁾	P _{N 100K}	kW	7.0	
Maximum torque 20 °C (cold) ¹⁾	M _{max 20°C}	Nm	345	
Maximum torque 100K (warm) ¹⁾	M _{max 100K}	Nm	328	
Maximum current	I _{max(eff)}	A	220	
Maximum speed (electrical)	n _{max el}	1/min	3600	
Maximum speed (mechanical)	n _{max mech}	1/min	3600	
Number of pole pairs	p		3	
Torque constant at 20 °C ¹⁾	K _m	Nm/A	1.81	
Voltage constant at 20 °C ¹⁾	K _E	V/1000 min ⁻¹	112	
Winding resistance at 20 °C	R ₁₂	Ohm	0.08	
Winding inductance	L _{12,min}	mH	3.0	
Leakage capacitance of the component	C _{ab}	nF	10.1	
Thermal time constant of winding	T _{th,W}	s	350	
Thermal time constant of motor	T _{th,M}	min	60	
Mass	m _{mot}	kg	89	95
Holding brake				
Holding torque	M ₄	Nm	0	115.00
Rated voltage	U _N	V	0	24
Rated current	I _N	A	0	2.10
Maximum connection time	t ₁	ms	0	100
Maximum disconnection time	t ₂	ms	0	240

1) For tolerance details refer to [chapter 6.4 Tolerances](#)

Latest amendment: 2022-03-04

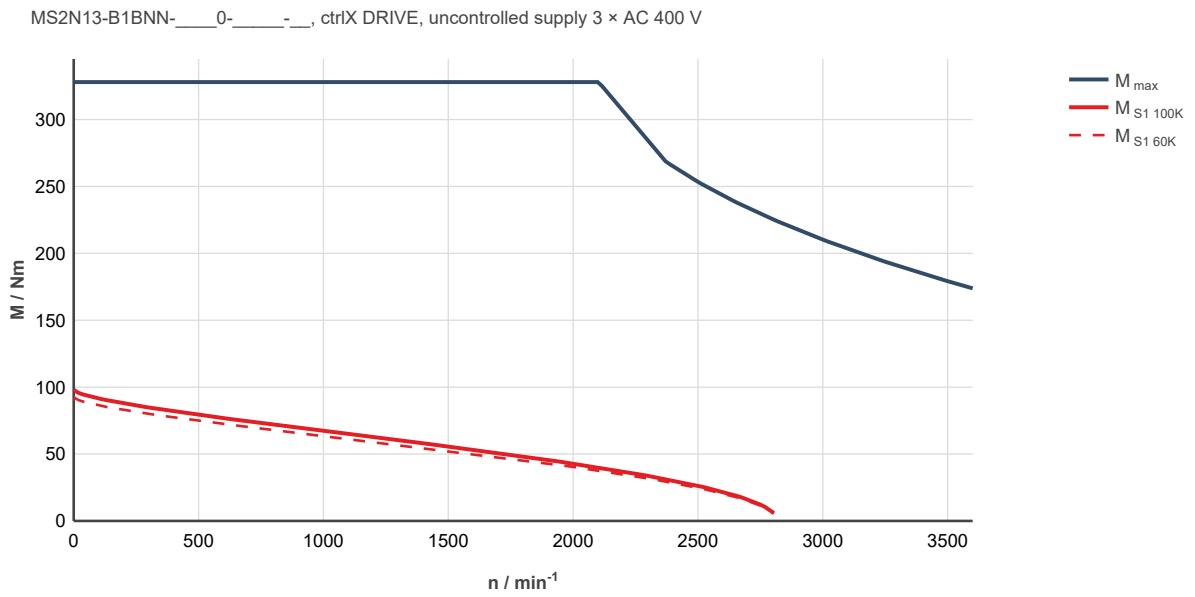

Fig. 304: MS2N13-B1BNN-___0-___-___, ctrlX DRIVE, uncontrolled supply 3 × AC 400 V

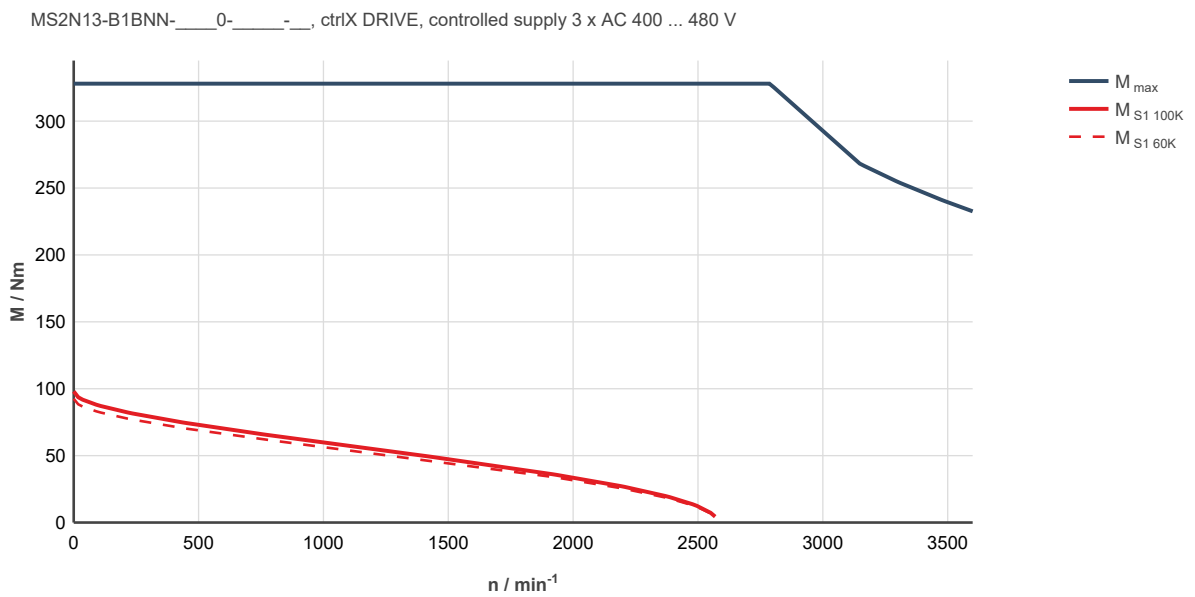

Fig. 305: MS2N13-B1BNN-___0-___-___, ctrlX DRIVE, controlled supply 3 x AC 400 ... 480 V

MS2N13-C1BHN

Designation	Symbol	Unit	MS2N13-C1BHN-__0-_N	MS2N13-C1BHN-__2-_N
Standstill torque - 60K ¹⁾	M _{0 60K}	Nm	122	
Standstill current - 60K	I _{0 60K}	A	48.4	
Standstill torque - 100K ¹⁾	M _{0 100K}	Nm	132	
Standstill current - 100K	I _{0 100K}	A	52.3	
Moment of inertia of rotor ¹⁾	J _{rot}	kg*m ²	0.0618	0.0835
Rated speed - 100K	n _{N 100K}	1/min	2,000	
Rated torque - 100K ¹⁾	M _{N 100K}	Nm	50.1	
Rated current - 100K	I _{N 100K}	A	21.1	
Rated power - 100K ¹⁾	P _{N 100K}	kW	10.5	
Maximum torque 20 °C (cold) ¹⁾	M _{max 20°C}	Nm	455	
Maximum torque 100K (warm) ¹⁾	M _{max 100K}	Nm	430	
Maximum current	I _{max(eff)}	A	205	
Maximum speed (electrical)	n _{max el}	1/min	3600	
Maximum speed (mechanical)	n _{max mech}	1/min	3600	
Number of pole pairs	p		3	
Torque constant at 20 °C ¹⁾	K _m	Nm/A	2.54	
Voltage constant at 20 °C ¹⁾	K _E	V/1000 min ⁻¹	155.3	
Winding resistance at 20 °C	R ₁₂	Ohm	0.097	
Winding inductance	L _{12,min}	mH	3.8	
Leakage capacitance of the component	C _{ab}	nF	13	
Thermal time constant of winding	T _{th,W}	s	310	
Thermal time constant of motor	T _{th,M}	min	63	
Mass	m _{mot}	kg	105	123
Holding brake				
Holding torque	M ₄	Nm	0	280.00
Rated voltage	U _N	V	0	24
Rated current	I _N	A	0	1.70
Maximum connection time	t ₁	ms	0	300
Maximum disconnection time	t ₂	ms	0	350

1) For tolerance details refer to [chapter 6.4 Tolerances](#) Latest amendment: 2022-02-03

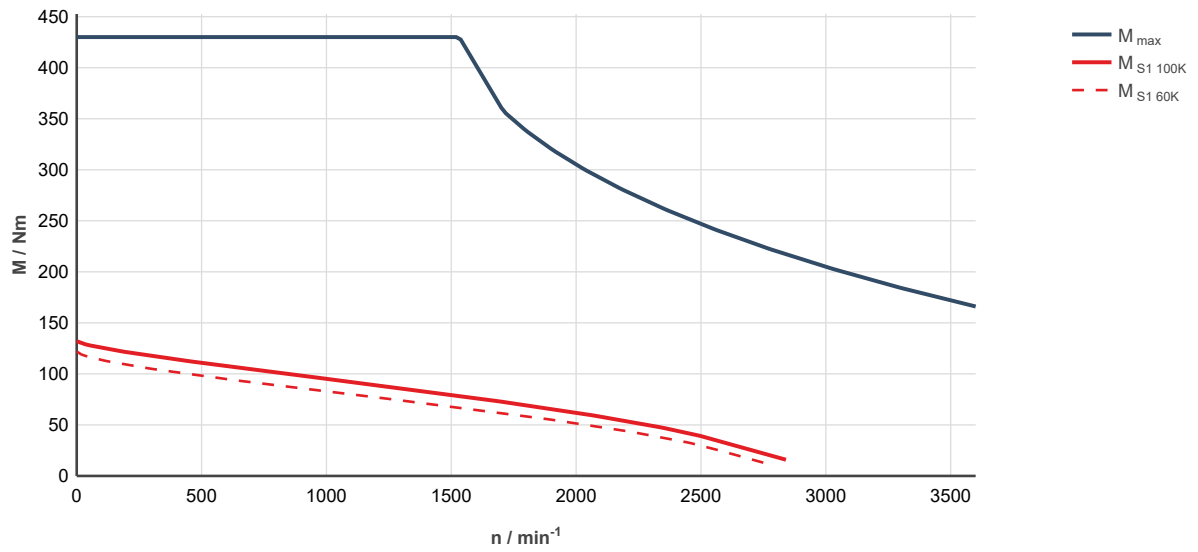

Fig. 306: MS2N13-C1BHN-___0-___-_, ctrlX DRIVE, uncontrolled supply 3 × AC 400 V

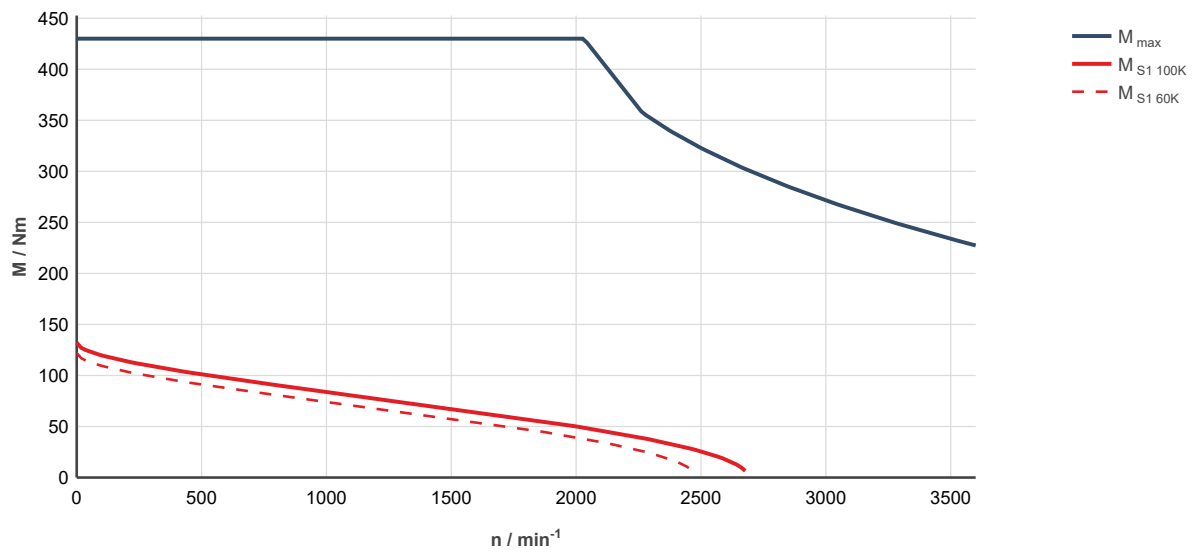

Fig. 307: MS2N13-C1BHN-___0-___-_, ctrlX DRIVE, controlled supply 3 x AC 400 ... 480 V

MS2N13-C1BNN

Designation	Symbol	Unit	MS2N13-C1BNN-__0-_N	MS2N13-C1BNN-__2-_N
Standstill torque - 60K ¹⁾	M _{0 60K}	Nm	122	
Standstill current - 60K	I _{0 60K}	A	63.5	
Standstill torque - 100K ¹⁾	M _{0 100K}	Nm	132	
Standstill current - 100K	I _{0 100K}	A	69	
Moment of inertia of rotor ¹⁾	J _{rot}	kg*m ²	0.0618	0.0835
Rated speed - 100K	n _{N 100K}	1/min	1,500	
Rated torque - 100K ¹⁾	M _{N 100K}	Nm	59.3	
Rated current - 100K	I _{N 100K}	A	32.3	
Rated power - 100K ¹⁾	P _{N 100K}	kW	9.3	
Maximum torque 20 °C (cold) ¹⁾	M _{max 20°C}	Nm	455	
Maximum torque 100K (warm) ¹⁾	M _{max 100K}	Nm	430	
Maximum current	I _{max(eff)}	A	270	
Maximum speed (electrical)	n _{max el}	1/min	3600	
Maximum speed (mechanical)	n _{max mech}	1/min	3600	
Number of pole pairs	p		3	
Torque constant at 20 °C ¹⁾	K _m	Nm/A	1.93	
Voltage constant at 20 °C ¹⁾	K _E	V/1000 min ⁻¹	119	
Winding resistance at 20 °C	R ₁₂	Ohm	0.059	
Winding inductance	L _{12,min}	mH	2.5	
Leakage capacitance of the component	C _{ab}	nF	13	
Thermal time constant of winding	T _{th,W}	s	310	
Thermal time constant of motor	T _{th,M}	min	63	
Mass	m _{mot}	kg	105	123
Holding brake				
Holding torque	M ₄	Nm	0	280.00
Rated voltage	U _N	V	0	24
Rated current	I _N	A	0	1.70
Maximum connection time	t ₁	ms	0	300
Maximum disconnection time	t ₂	ms	0	350
1) For tolerance details refer to chapter 6.4 Tolerances			Latest amendment: 2022-03-21	

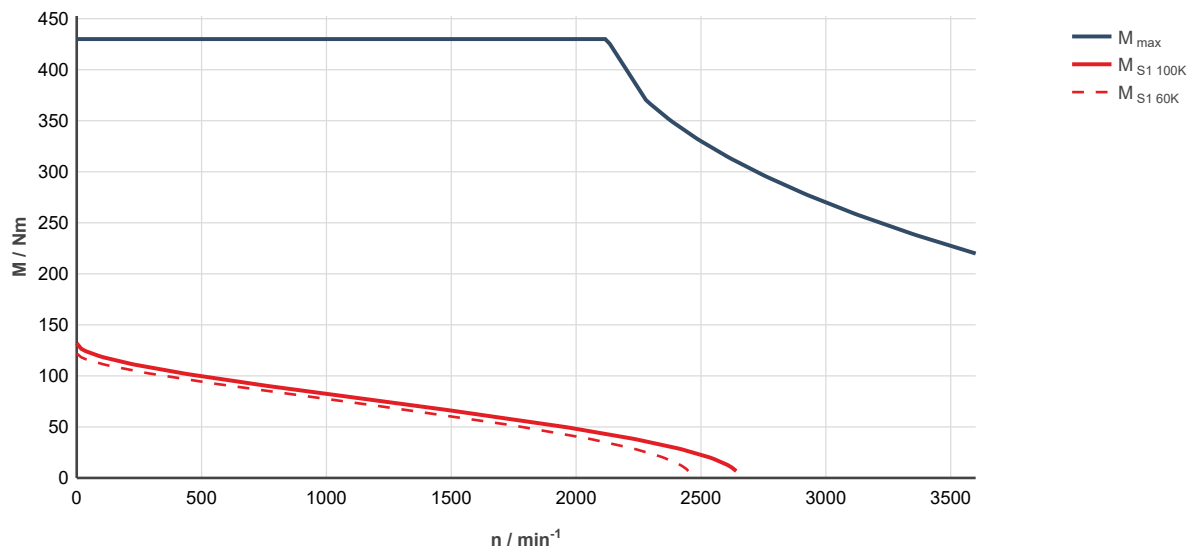

Fig. 308: MS2N13-C1BNN-___0-___-_, ctrlX DRIVE, uncontrolled supply 3 × AC 400 V

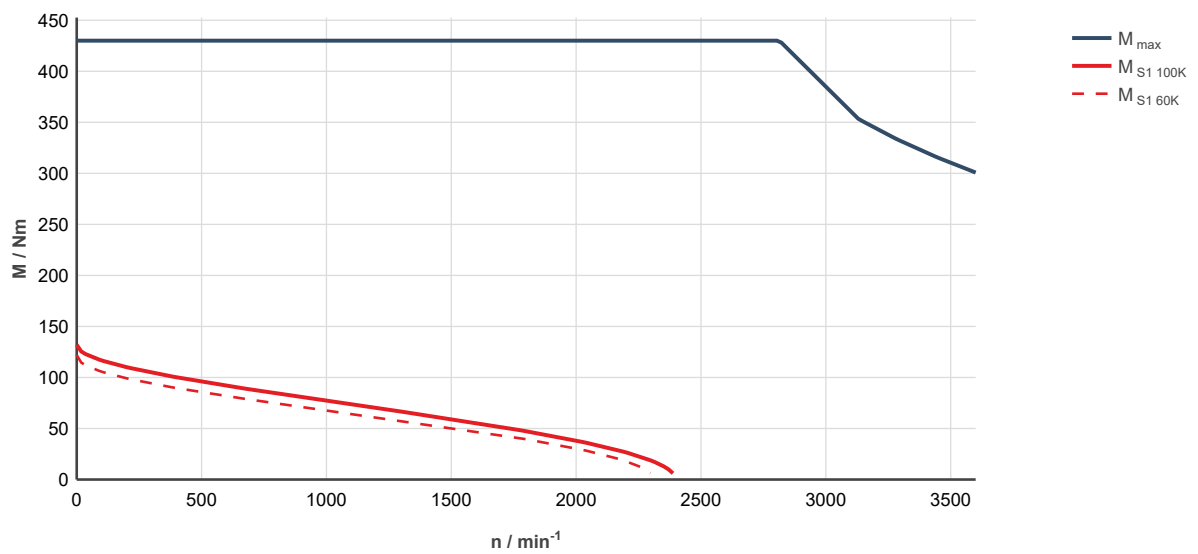

Fig. 309: MS2N13-C1BNN-___0-___-_, ctrlX DRIVE, controlled supply 3 x AC 400 ... 480 V

MS2N13-D1BHN

Designation	Symbol	Unit	MS2N13-D1BHN-__0-_N	MS2N13-D1BHN-__2-_N
Standstill torque - 60K ¹⁾	M _{0 60K}	Nm	142	
Standstill current - 60K	I _{0 60K}	A	56.5	
Standstill torque - 100K ¹⁾	M _{0 100K}	Nm	158	
Standstill current - 100K	I _{0 100K}	A	62.5	
Moment of inertia of rotor ¹⁾	J _{rot}	kg*m ²	0.078	0.0976
Rated speed - 100K	n _{N 100K}	1/min	1,500	
Rated torque - 100K ¹⁾	M _{N 100K}	Nm	67	
Rated current - 100K	I _{N 100K}	A	27.8	
Rated power - 100K ¹⁾	P _{N 100K}	kW	10.5	
Maximum torque 20 °C (cold) ¹⁾	M _{max 20°C}	Nm	578	
Maximum torque 100K (warm) ¹⁾	M _{max 100K}	Nm	546	
Maximum current	I _{max(eff)}	A	265	
Maximum speed (electrical)	n _{max el}	1/min	3600	
Maximum speed (mechanical)	n _{max mech}	1/min	3600	
Number of pole pairs	p		3	
Torque constant at 20 °C ¹⁾	K _m	Nm/A	2.56	
Voltage constant at 20 °C ¹⁾	K _E	V/1000 min ⁻¹	156	
Winding resistance at 20 °C	R ₁₂	Ohm	0.072	
Winding inductance	L _{12,min}	mH	3.4	
Leakage capacitance of the component	C _{ab}	nF	16.35	
Thermal time constant of winding	T _{th,W}	s	280	
Thermal time constant of motor	T _{th,M}	min	70	
Mass	m _{mot}	kg	124	142
Holding brake				
Holding torque	M ₄	Nm	0	280.00
Rated voltage	U _N	V	0	24
Rated current	I _N	A	0	1.70
Maximum connection time	t ₁	ms	0	300
Maximum disconnection time	t ₂	ms	0	350
1) For tolerance details refer to chapter 6.4 Tolerances			Latest amendment: 2021-12-16	

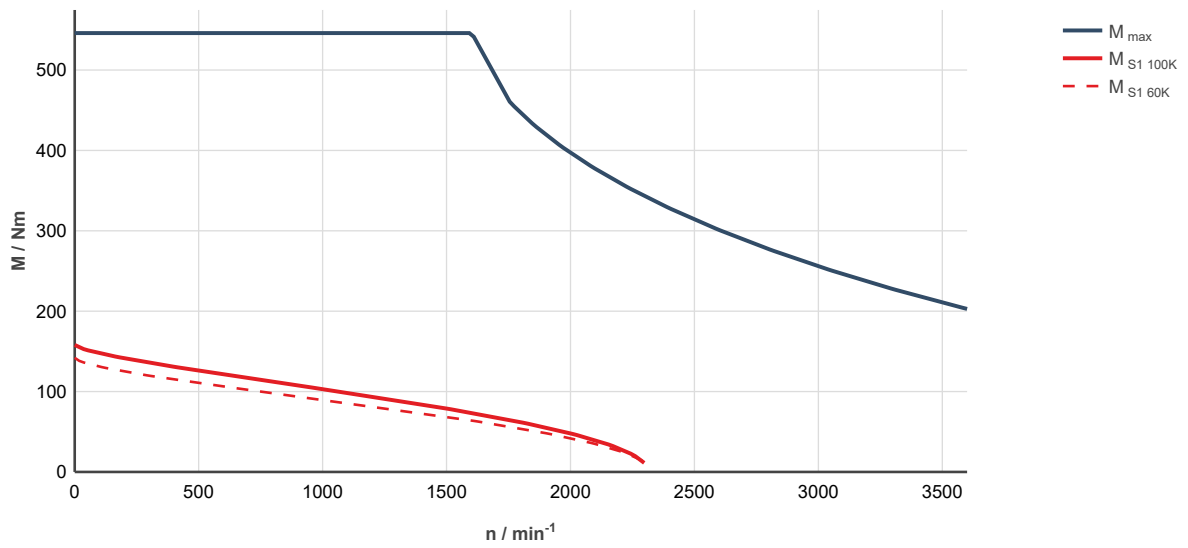

Fig. 310: MS2N13-D1BHN-___0-___-_, ctrlX DRIVE, uncontrolled supply 3 × AC 400 V

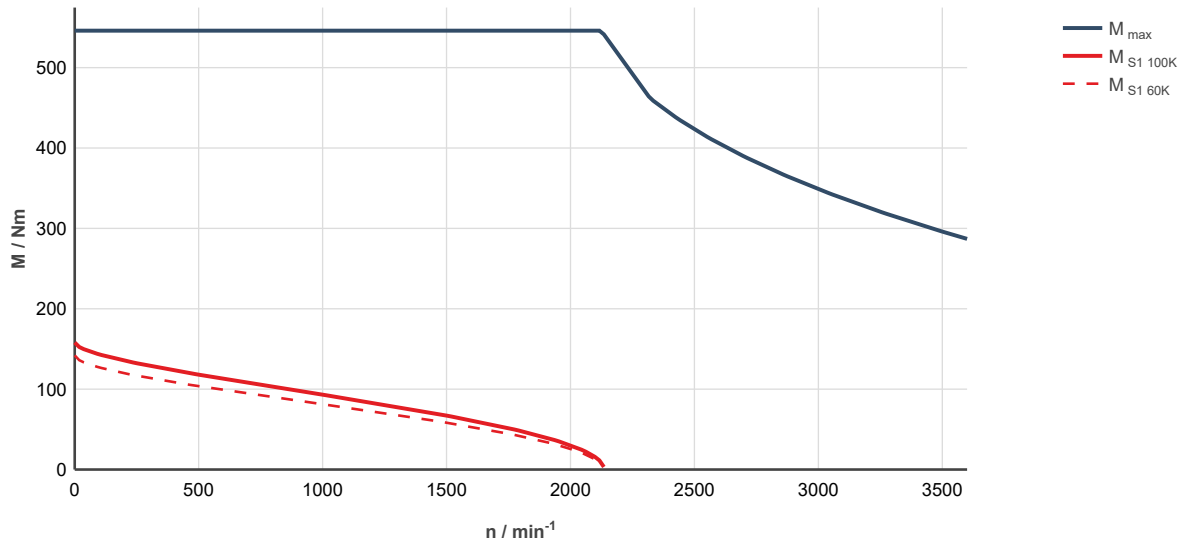

Fig. 311: MS2N13-D1BHN-___0-___-_, ctrlX DRIVE, controlled supply 3 x AC 400 ... 480 V

MS2N13-D1BNN

Designation	Symbol	Unit	MS2N13-D1BNN-__0-_N	MS2N13-D1BNN-__2-_N
Standstill torque - 60K ¹⁾	M _{0 60K}	Nm	142	
Standstill current - 60K	I _{0 60K}	A	74.3	
Standstill torque - 100K ¹⁾	M _{0 100K}	Nm	158	
Standstill current - 100K	I _{0 100K}	A	83	
Moment of inertia of rotor ¹⁾	J _{rot}	kg*m ²	0.078	0.0976
Rated speed - 100K	n _{N 100K}	1/min	1,500	
Rated torque - 100K ¹⁾	M _{N 100K}	Nm	57.2	
Rated current - 100K	I _{N 100K}	A	31.9	
Rated power - 100K ¹⁾	P _{N 100K}	kW	9.0	
Maximum torque 20 °C (cold) ¹⁾	M _{max 20°C}	Nm	578	
Maximum torque 100K (warm) ¹⁾	M _{max 100K}	Nm	546	
Maximum current	I _{max(eff)}	A	354	
Maximum speed (electrical)	n _{max el}	1/min	3600	
Maximum speed (mechanical)	n _{max mech}	1/min	3600	
Number of pole pairs	p		3	
Torque constant at 20 °C ¹⁾	K _m	Nm/A	1.91	
Voltage constant at 20 °C ¹⁾	K _E	V/1000 min ⁻¹	116.9	
Winding resistance at 20 °C	R ₁₂	Ohm	0.046	
Winding inductance	L _{12,min}	mH	1.9	
Leakage capacitance of the component	C _{ab}	nF	19.5	
Thermal time constant of winding	T _{th,W}	s	280	
Thermal time constant of motor	T _{th,M}	min	70	
Mass	m _{mot}	kg	124	142
Holding brake				
Holding torque	M ₄	Nm	0	280.00
Rated voltage	U _N	V	0	24
Rated current	I _N	A	0	1.70
Maximum connection time	t ₁	ms	0	300
Maximum disconnection time	t ₂	ms	0	350

1) For tolerance details refer to [chapter 6.4 Tolerances](#)

Latest amendment: 2022-02-09

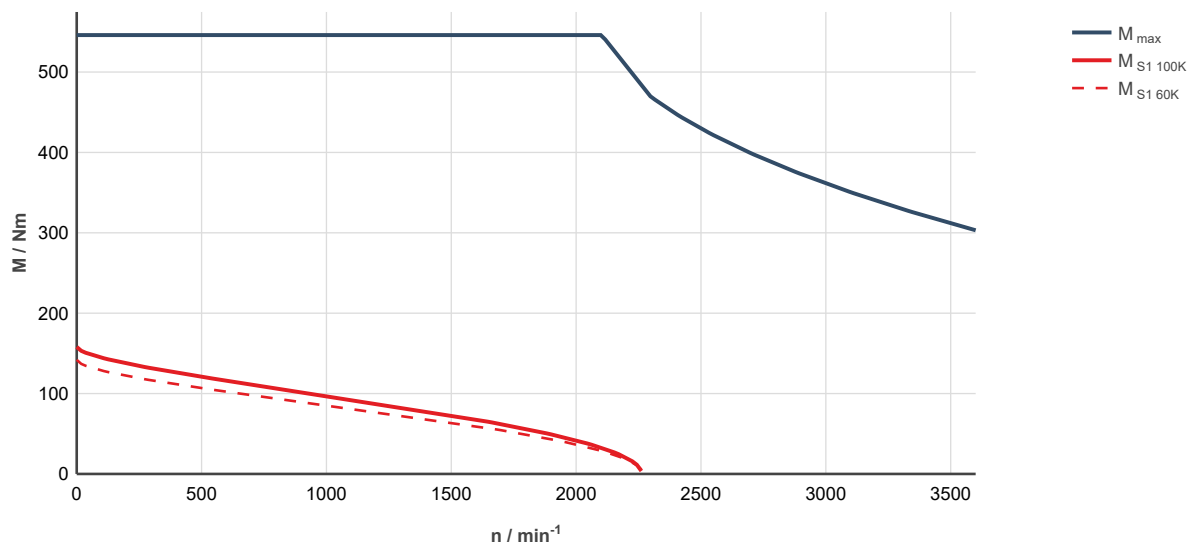

Fig. 312: MS2N13-D1BNN-___0-___-_, ctrlX DRIVE, uncontrolled supply 3 × AC 400 V

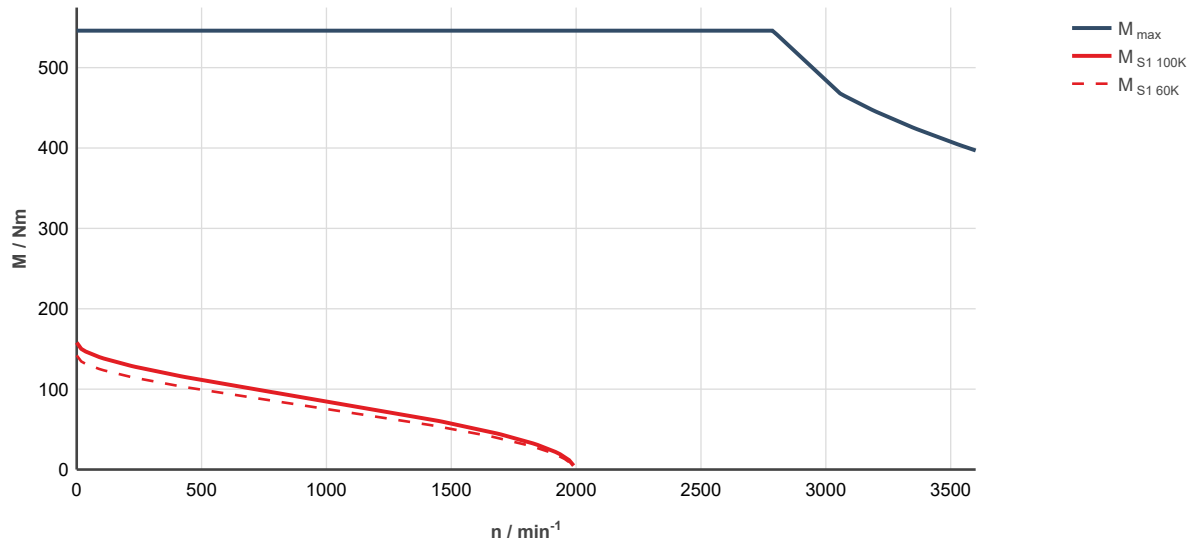

Fig. 313: MS2N13-D1BNN-___0-___-_, ctrlX DRIVE, controlled supply 3 x AC 400 ... 480 V

MS2N13-E1BHN

Designation	Symbol	Unit	MS2N13-E1BHN-__0-_N	MS2N13-E1BHN-__2-_N
Standstill torque - 60K ¹⁾	M _{0 60K}	Nm	166.0	
Standstill current - 60K	I _{0 60K}	A	64.7	
Standstill torque - 100K ¹⁾	M _{0 100K}	Nm	188.0	
Standstill current - 100K	I _{0 100K}	A	73.2	
Moment of inertia of rotor ¹⁾	J _{rot}	kg*m ²	0.09	0.1117
Rated speed - 100K	n _{N 100K}	1/min	1200	
Rated torque - 100K ¹⁾	M _{N 100K}	Nm	85.9	
Rated current - 100K	I _{N 100K}	A	34.4	
Rated power - 100K ¹⁾	P _{N 100K}	kW	10.8	
Maximum torque 20 °C (cold) ¹⁾	M _{max 20°C}	Nm	692	
Maximum torque 100K (warm) ¹⁾	M _{max 100K}	Nm	657	
Maximum current	I _{max(eff)}	A	305	
Maximum speed (electrical)	n _{max el}	1/min	3600	
Maximum speed (mechanical)	n _{max mech}	1/min	3600	
Number of pole pairs	p		3	
Torque constant at 20 °C ¹⁾	K _m	Nm/A	2.60	
Voltage constant at 20 °C ¹⁾	K _E	V/1000 min ⁻¹	159.8	
Winding resistance at 20 °C	R ₁₂	Ohm	0.058	
Winding inductance	L _{12,min}	mH	2.6	
Leakage capacitance of the component	C _{ab}	nF	24.3	
Thermal time constant of winding	T _{th,W}	s	250	
Thermal time constant of motor	T _{th,M}	min	80	
Mass	m _{mot}	kg	143	161
Holding brake				
Holding torque	M ₄	Nm	0	280.00
Rated voltage	U _N	V	0	24
Rated current	I _N	A	0	1.70
Maximum connection time	t ₁	ms	0	300
Maximum disconnection time	t ₂	ms	0	350

1) For tolerance details refer to [chapter 6.4 Tolerances](#)

Latest amendment: 2022-03-28

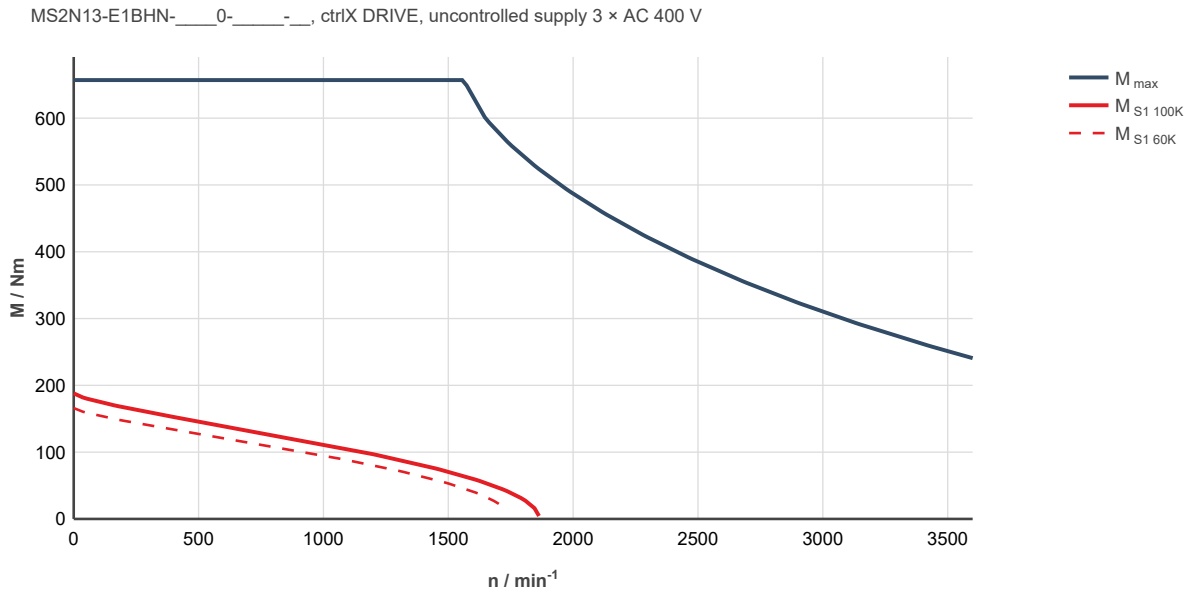

Fig. 314: MS2N13-E1BHN-___0-___-___, ctrlX DRIVE, uncontrolled supply 3 × AC 400 V

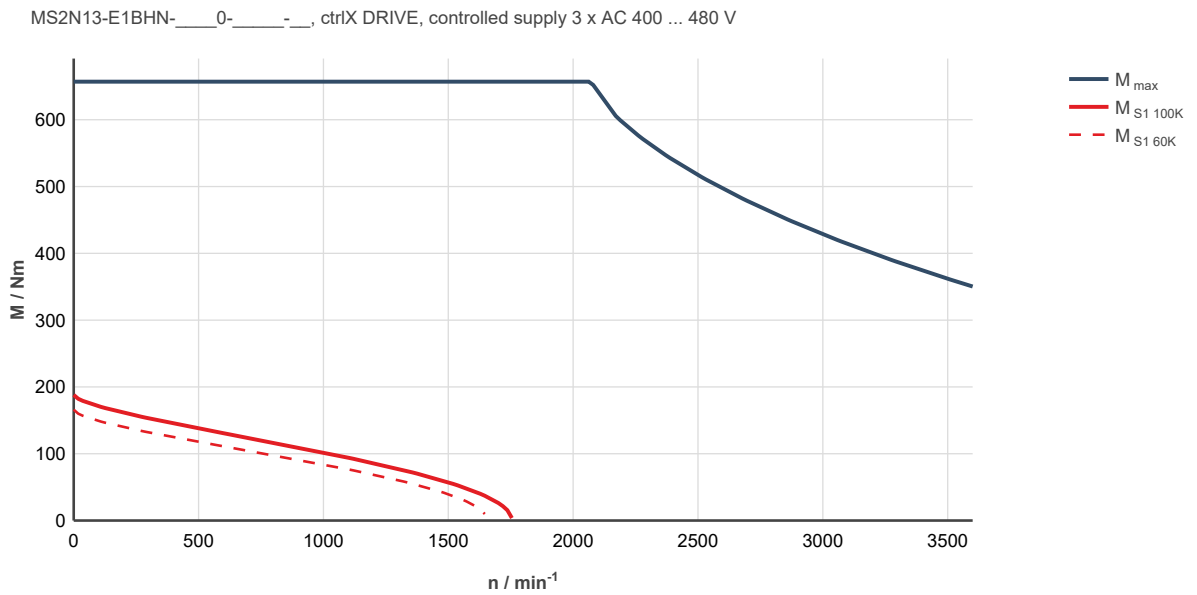

Fig. 315: MS2N13-E1BHN-___0-___-___, ctrlX DRIVE, controlled supply 3 x AC 400 ... 480 V

MS2N13-E1BNN

Designation	Symbol	Unit	MS2N13-E1BNN-__0-_N	MS2N13-E1BNN-__2-_N
Standstill torque - 60K ¹⁾	M _{0 60K}	Nm	166.0	
Standstill current - 60K	I _{0 60K}	A	83.8	
Standstill torque - 100K ¹⁾	M _{0 100K}	Nm	188.0	
Standstill current - 100K	I _{0 100K}	A	94.8	
Moment of inertia of rotor ¹⁾	J _{rot}	kg*m ²	0.09	0.1117
Rated speed - 100K	n _{N 100K}	1/min	900	
Rated torque - 100K ¹⁾	M _{N 100K}	Nm	93.7	
Rated current - 100K	I _{N 100K}	A	48.9	
Rated power - 100K ¹⁾	P _{N 100K}	kW	8.8	
Maximum torque 20 °C (cold) ¹⁾	M _{max 20°C}	Nm	692	
Maximum torque 100K (warm) ¹⁾	M _{max 100K}	Nm	657	
Maximum current	I _{max(eff)}	A	400	
Maximum speed (electrical)	n _{max el}	1/min	3600	
Maximum speed (mechanical)	n _{max mech}	1/min	3600	
Number of pole pairs	p		3	
Torque constant at 20 °C ¹⁾	K _m	Nm/A	1.83	
Voltage constant at 20 °C ¹⁾	K _E	V/1000 min ⁻¹	122.4	
Winding resistance at 20 °C	R ₁₂	Ohm	0.033	
Winding inductance	L _{12,min}	mH	1.5	
Leakage capacitance of the component	C _{ab}	nF	21.8	
Thermal time constant of winding	T _{th,W}	s	250	
Thermal time constant of motor	T _{th,M}	min	80	
Mass	m _{mot}	kg	143	161
Holding brake				
Holding torque	M ₄	Nm	0	280.00
Rated voltage	U _N	V	0	24
Rated current	I _N	A	0	1.70
Maximum connection time	t ₁	ms	0	300
Maximum disconnection time	t ₂	ms	0	350

1) For tolerance details refer to [chapter 6.4 Tolerances](#)

Latest amendment: 2022-03-28

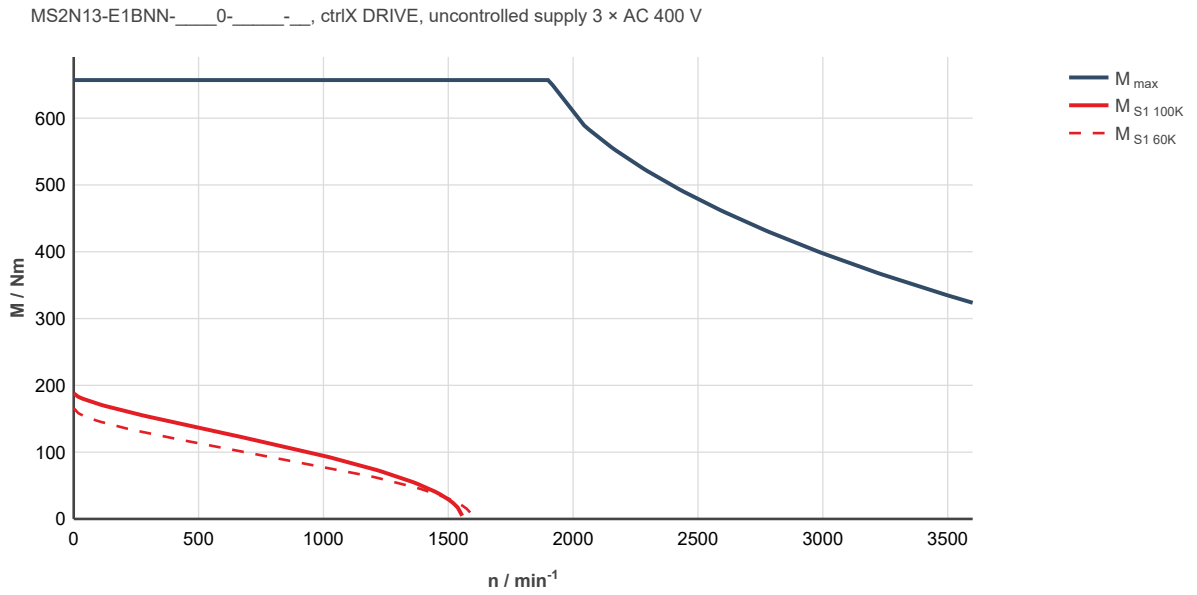

Fig. 316: MS2N13-E1BNN-___0-___-___, ctrlX DRIVE, uncontrolled supply 3 × AC 400 V

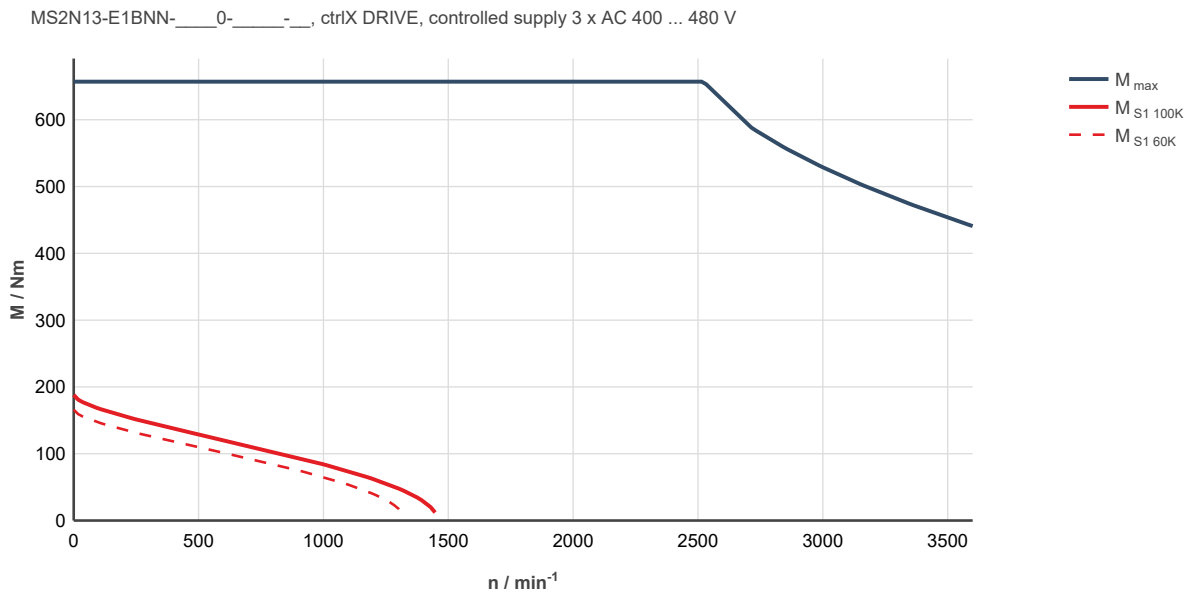

Fig. 317: MS2N13-E1BNN-___0-___-___, ctrlX DRIVE, controlled supply 3 x AC 400 ... 480 V

7.7.2 Forced ventilation

MS2N13-B1BHC Technical data

Designation	Symbol	Unit	MS2N13-B1BHC-__0-N	MS2N13-B1BHC-__1-N
Standstill torque - 100K ¹⁾	M _{0 100K}	Nm	160	
Standstill current - 100K	I _{0 100K}	A	63	
Moment of inertia of rotor ¹⁾	J _{rot}	kg*m ²	0.0476	0.055
Rated speed - 100K	n _{N 100K}	1/min	2,000	
Rated torque - 100K ¹⁾	M _{N 100K}	Nm	139	
Rated current - 100K	I _{N 100K}	A	56	
Rated power - 100K ¹⁾	P _{N 100K}	kW	29	
Maximum torque 20 °C (cold) ¹⁾	M _{max 20°C}	Nm	345	
Maximum torque 100K (warm) ¹⁾	M _{max 100K}	Nm	328	
Maximum current	I _{max(eff)}	A	160	
Maximum speed (electrical)	n _{max el}	1/min	3600	
Maximum speed (mechanical)	n _{max mech}	1/min	3600	
Number of pole pairs	p		3	
Torque constant at 20 °C ¹⁾	K _m	Nm/A	2.52	
Voltage constant at 20 °C ¹⁾	K _E	V/1000 min ⁻¹	154	
Winding resistance at 20 °C	R ₁₂	Ohm	0.145	
Winding inductance	L _{12_min}	mH	5.6	
Leakage capacitance of the component	C _{ab}	nF	11.3	
Thermal time constant of winding	T _{th_w}	s	300	
Thermal time constant of motor	T _{th_M}	min	14.8	
Mass	m _{mot}	kg	92	98
Holding brake				
Holding torque	M ₄	Nm	0	115.00
Rated voltage	U _N	V	0	24
Rated current	I _N	A	0	2.10
Maximum connection time	t ₁	ms	0	100
Maximum disconnection time	t ₂	ms	0	240
Fan data				
Rated voltage	U _N	V	400/480	
Rated current	I _N	A	0.21/0.28	
Frequency	f _N	Hz	50/60	
1) For tolerance details refer to chapter 6.4 Tolerances			Latest amendment: 2022-02-03	

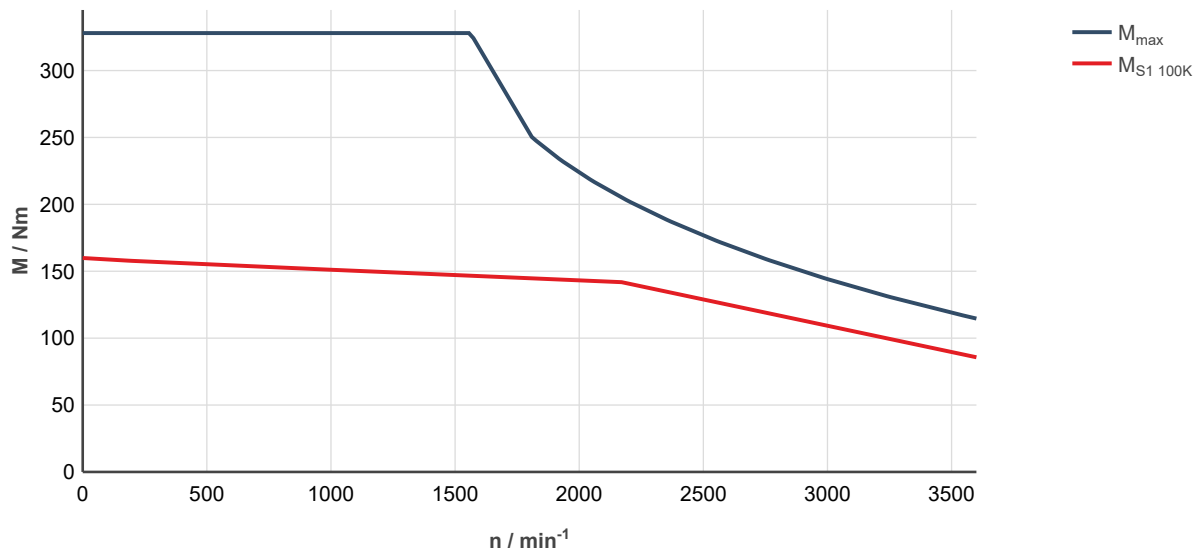

Fig. 318: MS2N13-B1BHC-___0-___-_, ctrIX DRIVE, uncontrolled supply 3 × AC 400 V
 M_{max} Characteristic curve applies to maximum torque 20 °C (cold)

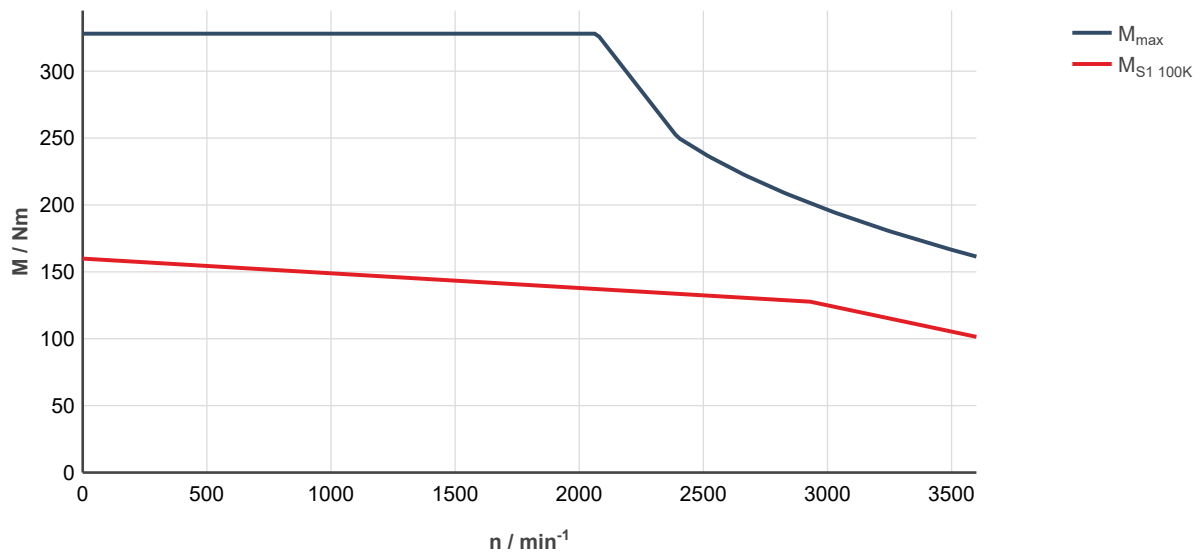

Fig. 319: MS2N13-B1BHC-___0-___-_, ctrIX DRIVE, controlled supply 3 × AC 400 ... 480 V
 M_{max} Characteristic curve applies to maximum torque 20 °C (cold)

MS2N13-B1BNC

Designation	Symbol	Unit	MS2N13-B1BNC-__0-N	MS2N13-B1BNC-__1-N
Standstill torque - 100K ¹⁾	M _{0 100K}	Nm	160	
Standstill current - 100K	I _{0 100K}	A	87.3	
Moment of inertia of rotor ¹⁾	J _{rot}	kg*m ²	0.0476	0.055
Rated speed - 100K	n _{N 100K}	1/min	2860	
Rated torque - 100K ¹⁾	M _{N 100K}	Nm	100.2	
Rated current - 100K	I _{N 100K}	A	56.5	
Rated power - 100K ¹⁾	P _{N 100K}	kW	30.0	
Maximum torque 20 °C (cold) ¹⁾	M _{max 20°C}	Nm	345	
Maximum torque 100K (warm) ¹⁾	M _{max 100K}	Nm	328	
Maximum current	I _{max(eff)}	A	220	
Maximum speed (electrical)	n _{max el}	1/min	3600	
Maximum speed (mechanical)	n _{max mech}	1/min	3600	
Number of pole pairs	p		3	
Torque constant at 20 °C ¹⁾	K _m	Nm/A	1.81	
Voltage constant at 20 °C ¹⁾	K _E	V/1000 min ⁻¹	112	
Winding resistance at 20 °C	R ₁₂	Ohm	0.08	
Winding inductance	L _{12_min}	mH	3.0	
Leakage capacitance of the component	C _{ab}	nF	10.1	
Thermal time constant of winding	T _{th_w}	s	300	
Thermal time constant of motor	T _{th_M}	min	18	
Mass	m _{mot}	kg	92	98
Holding brake				
Holding torque	M ₄	Nm	0	115.00
Rated voltage	U _N	V	0	24
Rated current	I _N	A	0	2.10
Maximum connection time	t ₁	ms	0	100
Maximum disconnection time	t ₂	ms	0	240
Fan data				
Rated voltage	U _N	V	400/480	
Rated current	I _N	A	0.21/0.28	
Frequency	f _N	Hz	50/60	
1) For tolerance details refer to chapter 6.4 Tolerances			Latest amendment: 2022-03-04	

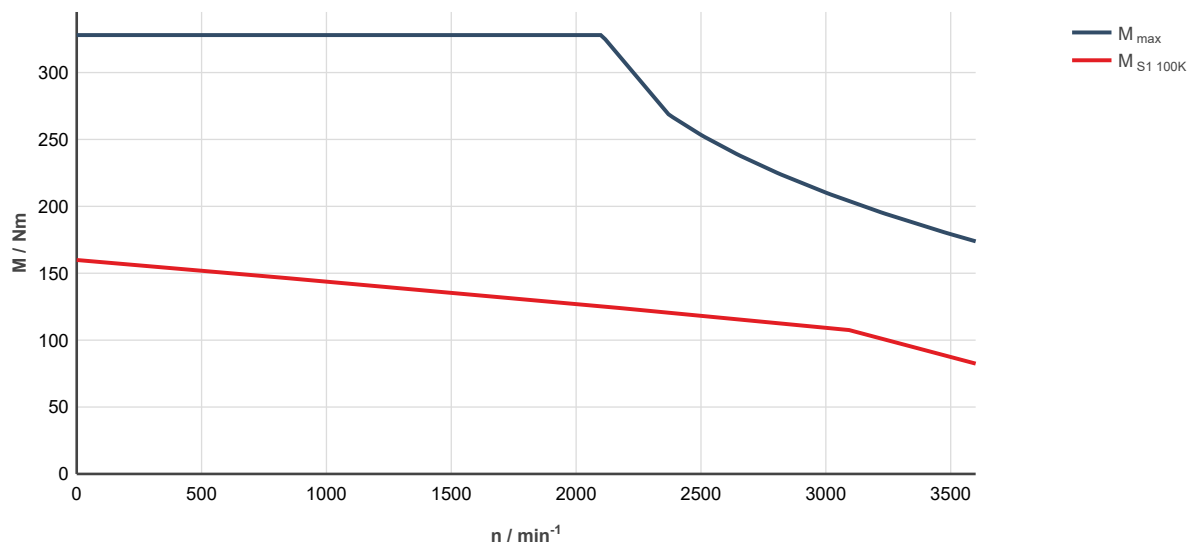

Fig. 320: MS2N13-B1BNC-___0-___-_, ctrlX DRIVE, uncontrolled supply 3 × AC 400 V

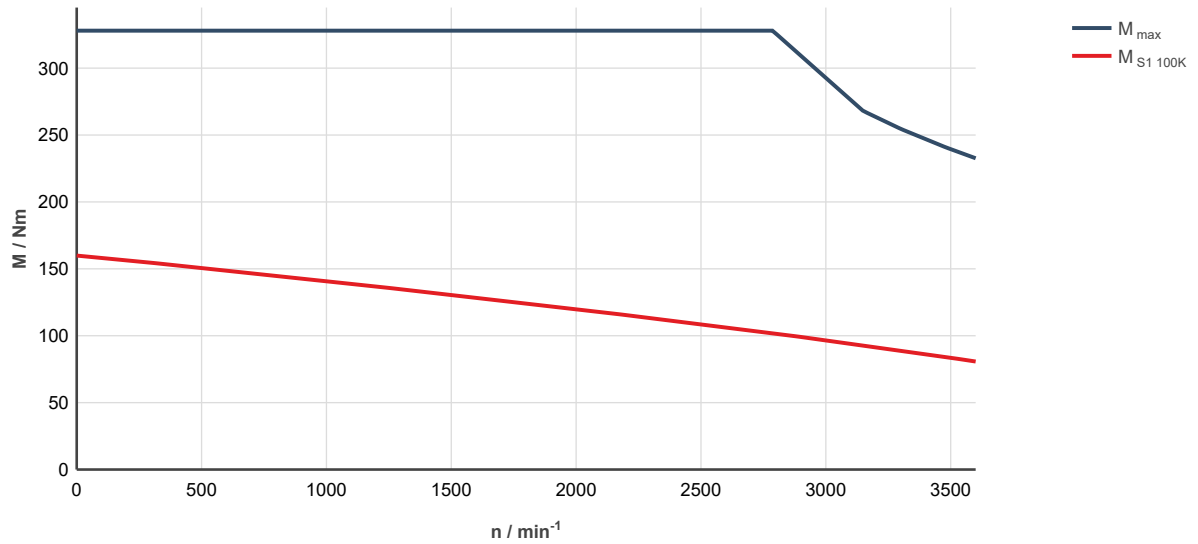

Fig. 321: MS2N13-B1BNC-___0-___-_, ctrlX DRIVE, controlled supply 3 x AC 400 ... 480 V

MS2N13-C1BHC

Designation	Symbol	Unit	MS2N13-C1BHC-__0-_N	MS2N13-C1BHC-__2-_N
Standstill torque - 100K ¹⁾	M _{0 100K}	Nm	216	
Standstill current - 100K	I _{0 100K}	A	85	
Moment of inertia of rotor ¹⁾	J _{rot}	kg*m ²	0.0618	0.0835
Rated speed - 100K	n _{N 100K}	1/min	2,000	
Rated torque - 100K ¹⁾	M _{N 100K}	Nm	183	
Rated current - 100K	I _{N 100K}	A	73.3	
Rated power - 100K ¹⁾	P _{N 100K}	kW	38.3	
Maximum torque 20 °C (cold) ¹⁾	M _{max 20°C}	Nm	455	
Maximum torque 100K (warm) ¹⁾	M _{max 100K}	Nm	430	
Maximum current	I _{max(eff)}	A	205	
Maximum speed (electrical)	n _{max el}	1/min	3600	
Maximum speed (mechanical)	n _{max mech}	1/min	3600	
Number of pole pairs	p		3	
Torque constant at 20 °C ¹⁾	K _m	Nm/A	2.54	
Voltage constant at 20 °C ¹⁾	K _E	V/1000 min ⁻¹	155.3	
Winding resistance at 20 °C	R ₁₂	Ohm	0.097	
Winding inductance	L _{12_min}	mH	3.8	
Leakage capacitance of the component	C _{ab}	nF	13	
Thermal time constant of winding	T _{th_w}	s	230	
Thermal time constant of motor	T _{th_M}	min	14.8	
Mass	m _{mot}	kg	108	126
Holding brake				
Holding torque	M ₄	Nm	0	280.00
Rated voltage	U _N	V	0	24
Rated current	I _N	A	0	1.70
Maximum connection time	t ₁	ms	0	300
Maximum disconnection time	t ₂	ms	0	350
Fan data				
Rated voltage	U _N	V	400/480	
Rated current	I _N	A	0.21/0.28	
Frequency	f _N	Hz	50/60	
1) For tolerance details refer to chapter 6.4 Tolerances			Latest amendment: 2021-03-24	

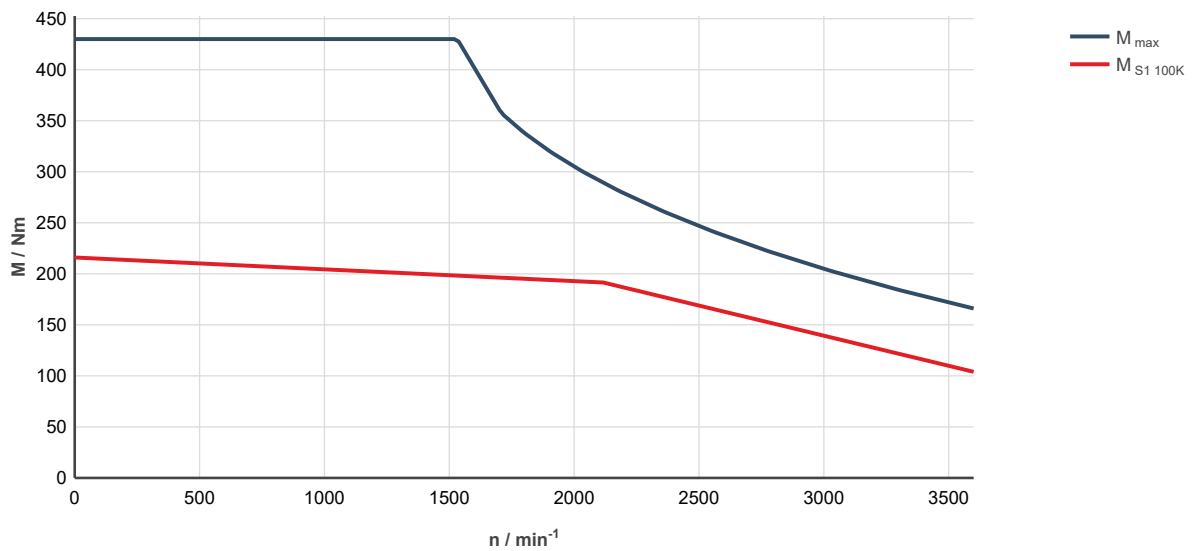

Fig. 322: MS2N13-C1BHC-___0-___-_, ctrIX DRIVE, uncontrolled supply 3 × AC 400 V
 M_{max} Characteristic curve applies to maximum torque 20 °C (cold)

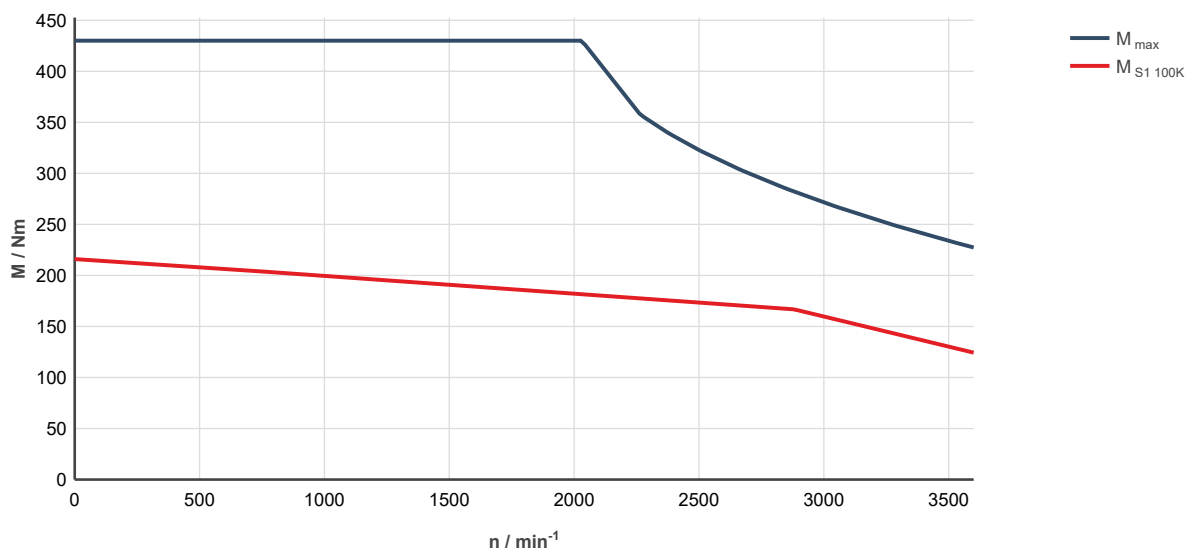

Fig. 323: MS2N13-C1BHC-___0-___-_, ctrIX DRIVE, controlled supply 3 × AC 400 ... 480 V
 M_{max} Characteristic curve applies to maximum torque 20 °C (cold)

MS2N13-C1BNC

Designation	Symbol	Unit	MS2N13-C1BNC-__0-_N	MS2N13-C1BNC-__2-_N
Standstill torque - 100K ¹⁾	M _{0 100K}	Nm	216	
Standstill current - 100K	I _{0 100K}	A	111.5	
Moment of inertia of rotor ¹⁾	J _{rot}	kg*m ²	0.0618	0.0835
Rated speed - 100K	n _{N 100K}	1/min	2860	
Rated torque - 100K ¹⁾	M _{N 100K}	Nm	136.8	
Rated current - 100K	I _{N 100K}	A	73.5	
Rated power - 100K ¹⁾	P _{N 100K}	kW	41.0	
Maximum torque 20 °C (cold) ¹⁾	M _{max 20°C}	Nm	457	
Maximum torque 100K (warm) ¹⁾	M _{max 100K}	Nm	430	
Maximum current	I _{max(eff)}	A	270	
Maximum speed (electrical)	n _{max el}	1/min	3600	
Maximum speed (mechanical)	n _{max mech}	1/min	3600	
Number of pole pairs	p		3	
Torque constant at 20 °C ¹⁾	K _m	Nm/A	1.93	
Voltage constant at 20 °C ¹⁾	K _E	V/1000 min ⁻¹	119	
Winding resistance at 20 °C	R ₁₂	Ohm	0.059	
Winding inductance	L _{12_min}	mH	2.5	
Leakage capacitance of the component	C _{ab}	nF	13	
Thermal time constant of winding	T _{th_W}	s	240	
Thermal time constant of motor	T _{th_M}	min	14.8	
Mass	m _{mot}	kg	108	126
Holding brake				
Holding torque	M ₄	Nm	0	280.00
Rated voltage	U _N	V	0	24
Rated current	I _N	A	0	1.70
Maximum connection time	t ₁	ms	0	300
Maximum disconnection time	t ₂	ms	0	350
Fan data				
Rated voltage	U _N	V	400/480	
Rated current	I _N	A	0.21/0.28	
Frequency	f _N	Hz	50/60	
1) For tolerance details refer to chapter 6.4 Tolerances			Latest amendment: 2022-03-21	

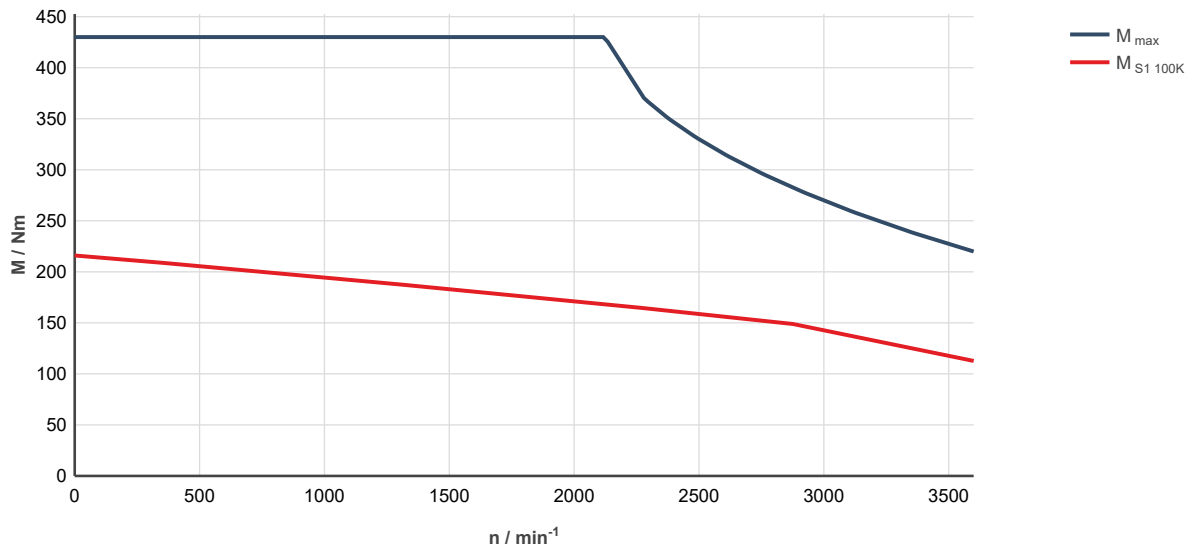

Fig. 324: MS2N13-C1BNC-___0-N___-___, ctrlX DRIVE, uncontrolled supply 3 x AC 400 V

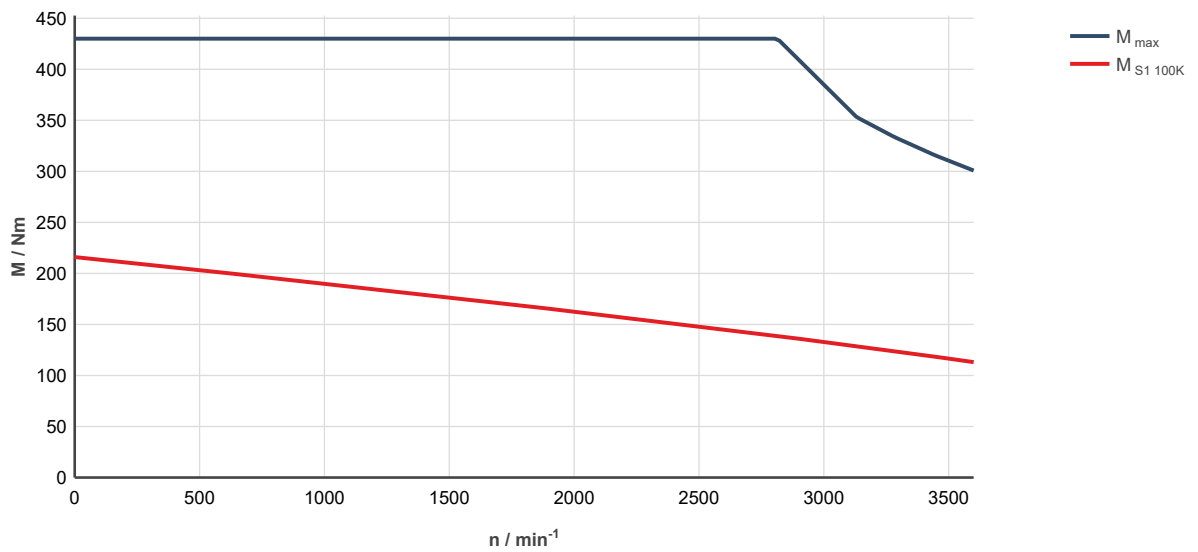

Fig. 325: MS2N13-C1BNC-___0-N___-___, ctrlX DRIVE, controlled supply 3 x AC 400 ... 480 V

MS2N13-D1BHC

Designation	Symbol	Unit	MS2N13-D1BHC-__0-_N	MS2N13-D1BHC-__2-_N
Standstill torque - 100K ¹⁾	M _{0 100K}	Nm	258	
Standstill current - 100K	I _{0 100K}	A	101.5	
Moment of inertia of rotor ¹⁾	J _{rot}	kg*m ²	0.078	0.0976
Rated speed - 100K	n _{N 100K}	1/min	2,000	
Rated torque - 100K ¹⁾	M _{N 100K}	Nm	205	
Rated current - 100K	I _{N 100K}	A	82.5	
Rated power - 100K ¹⁾	P _{N 100K}	kW	42.9	
Maximum torque 20 °C (cold) ¹⁾	M _{max 20°C}	Nm	578	
Maximum torque 100K (warm) ¹⁾	M _{max 100K}	Nm	546	
Maximum current	I _{max(eff)}	A	265	
Maximum speed (electrical)	n _{max el}	1/min	3600	
Maximum speed (mechanical)	n _{max mech}	1/min	3600	
Number of pole pairs	p		3	
Torque constant at 20 °C ¹⁾	K _m	Nm/A	2.56	
Voltage constant at 20 °C ¹⁾	K _E	V/1000 min ⁻¹	156	
Winding resistance at 20 °C	R ₁₂	Ohm	0.072	
Winding inductance	L _{12_min}	mH	3.4	
Leakage capacitance of the component	C _{ab}	nF	16.35	
Thermal time constant of winding	T _{th_w}	s	240	
Thermal time constant of motor	T _{th_M}	min	18	
Mass	m _{mot}	kg	127	144
Holding brake				
Holding torque	M ₄	Nm	0	280.00
Rated voltage	U _N	V	0	24
Rated current	I _N	A	0	1.70
Maximum connection time	t ₁	ms	0	300
Maximum disconnection time	t ₂	ms	0	350
Fan data				
Rated voltage	U _N	V	400/480	
Rated current	I _N	A	0.21/0.28	
Frequency	f _N	Hz	50/60	
1) For tolerance details refer to chapter 6.4 Tolerances			Latest amendment: 2021-03-05	

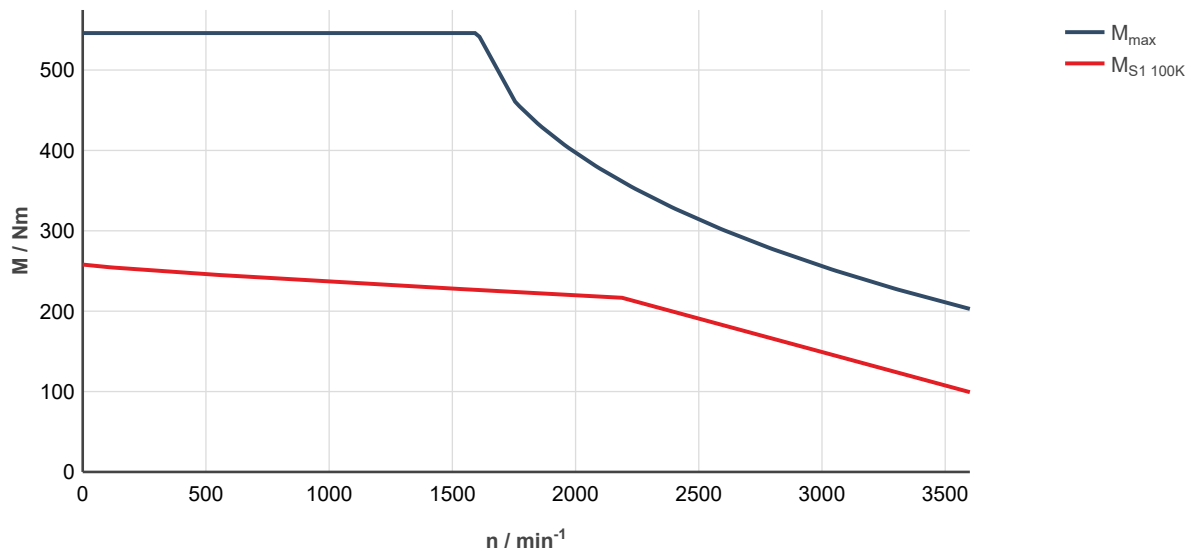

Fig. 326: MS2N13-D1BHC-___0-___-_, ctrlX DRIVE, uncontrolled supply 3 × AC 400 V(1)
 M_{max} Characteristic curve applies to maximum torque 20 °C (cold)

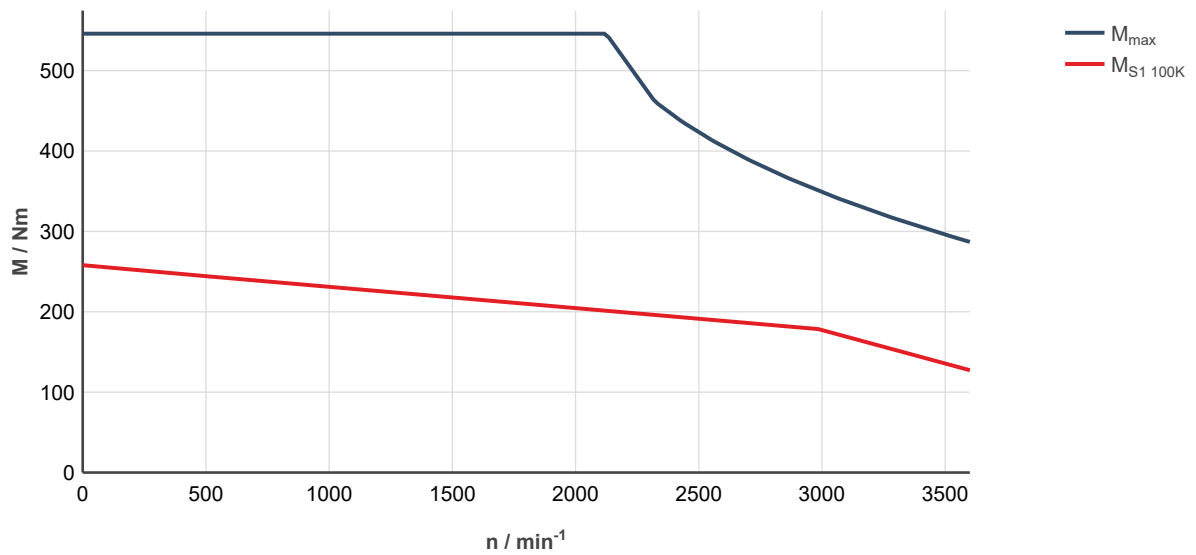

Fig. 327: MS2N13-D1BHC-___0-___-_, ctrlX DRIVE, controlled supply 3 x AC 400 ... 480 V
 M_{max} Characteristic curve applies to maximum torque 20 °C (cold)

MS2N13-D1BNC

Designation	Symbol	Unit	MS2N13-D1BNC-__0-_N	MS2N13-D1BNC-__2-_N
Standstill torque - 100K ¹⁾	M _{0 100K}	Nm	258	
Standstill current - 100K	I _{0 100K}	A	134.5	
Moment of inertia of rotor ¹⁾	J _{rot}	kg*m ²	0.078	0.0976
Rated speed - 100K	n _{N 100K}	1/min	3,000	
Rated torque - 100K ¹⁾	M _{N 100K}	Nm	133	
Rated current - 100K	I _{N 100K}	A	72	
Rated power - 100K ¹⁾	P _{N 100K}	kW	41.8	
Maximum torque 20 °C (cold) ¹⁾	M _{max 20°C}	Nm	578	
Maximum torque 100K (warm) ¹⁾	M _{max 100K}	Nm	546	
Maximum current	I _{max(eff)}	A	354	
Maximum speed (electrical)	n _{max el}	1/min	3600	
Maximum speed (mechanical)	n _{max mech}	1/min	3600	
Number of pole pairs	p		3	
Torque constant at 20 °C ¹⁾	K _m	Nm/A	1.91	
Voltage constant at 20 °C ¹⁾	K _E	V/1000 min ⁻¹	116.9	
Winding resistance at 20 °C	R ₁₂	Ohm	0.046	
Winding inductance	L _{12_min}	mH	1.9	
Leakage capacitance of the component	C _{ab}	nF	19.5	
Thermal time constant of winding	T _{th_w}	s	240	
Thermal time constant of motor	T _{th_M}	min	13.5	
Mass	m _{mot}	kg	127	144
Holding brake				
Holding torque	M ₄	Nm	0	280.00
Rated voltage	U _N	V	0	24
Rated current	I _N	A	0	1.70
Maximum connection time	t ₁	ms	0	300
Maximum disconnection time	t ₂	ms	0	350
Fan data				
Rated voltage	U _N	V	400/480	
Rated current	I _N	A	0.21/0.28	
Frequency	f _N	Hz	50/60	
1) For tolerance details refer to chapter 6.4 Tolerances			Latest amendment: 2022-05-04	

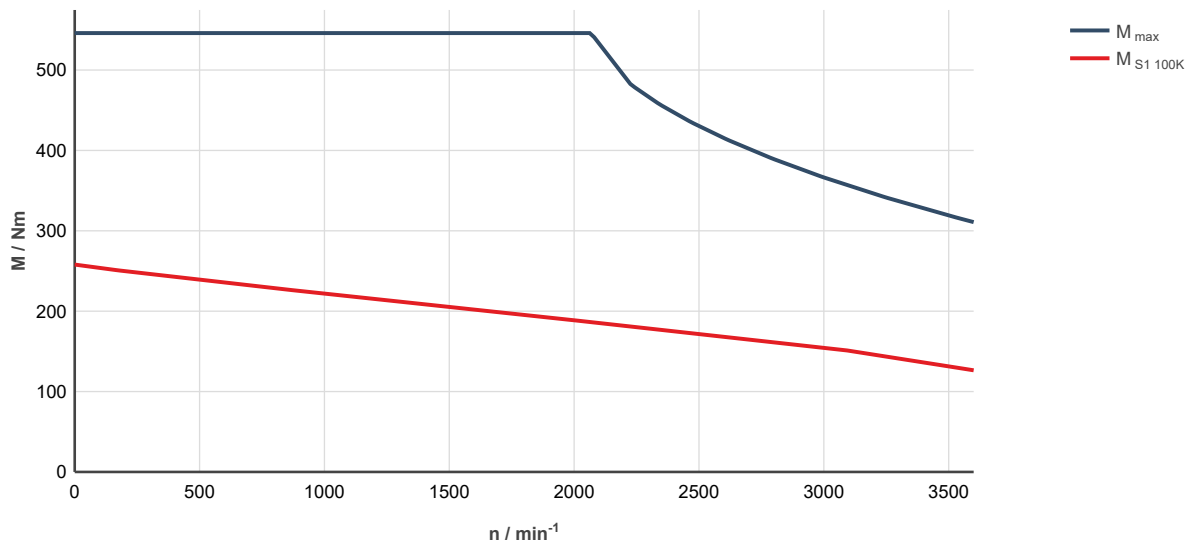

Fig. 328: MS2N13-D1BNC-___0-___-_, ctrlX DRIVE, uncontrolled supply 3 × AC 400 V

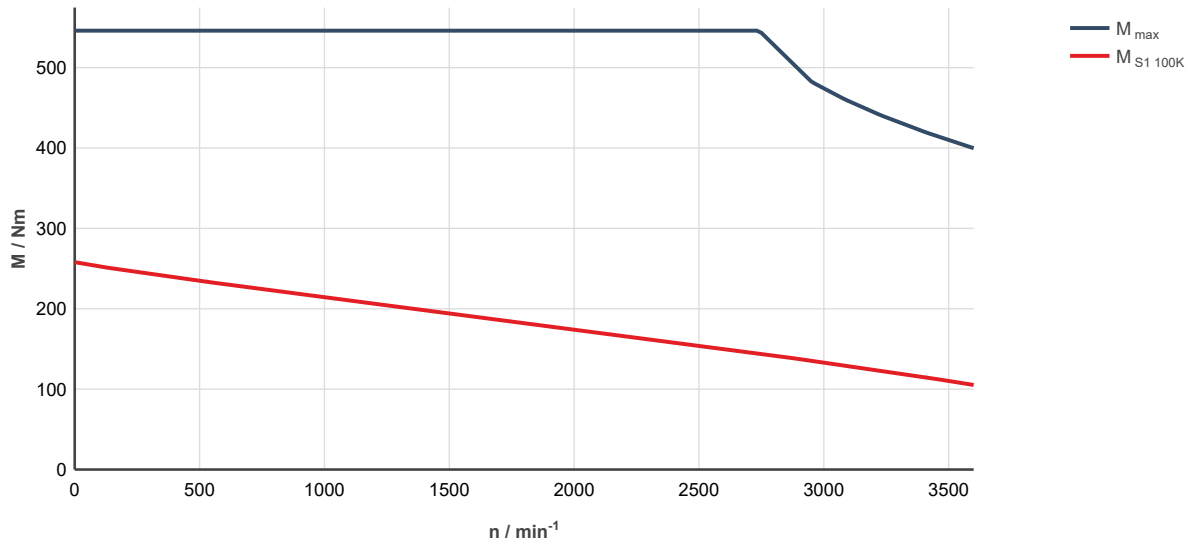

Fig. 329: MS2N13-D1BNC-___0-___-_, ctrlX DRIVE, controlled supply 3 x AC 400 ... 480 V

MS2N13-E1BHC

Designation	Symbol	Unit	MS2N13-E1BHC-__0-_N	MS2N13-E1BHC-__2-_N
Standstill torque - 100K ¹⁾	M _{0 100K}	Nm	300	
Standstill current - 100K	I _{0 100K}	A	116	
Moment of inertia of rotor ¹⁾	J _{rot}	kg*m ²	0.09	0.1117
Rated speed - 100K	n _{N 100K}	1/min	2,000	
Rated torque - 100K ¹⁾	M _{N 100K}	Nm	228	
Rated current - 100K	I _{N 100K}	A	90	
Rated power - 100K ¹⁾	P _{N 100K}	kW	47.8	
Maximum torque 20 °C (cold) ¹⁾	M _{max 20°C}	Nm	692	
Maximum torque 100K (warm) ¹⁾	M _{max 100K}	Nm	657	
Maximum current	I _{max(eff)}	A	305	
Maximum speed (electrical)	n _{max el}	1/min	3600	
Maximum speed (mechanical)	n _{max mech}	1/min	3600	
Number of pole pairs	p		3	
Torque constant at 20 °C ¹⁾	K _m	Nm/A	2.60	
Voltage constant at 20 °C ¹⁾	K _E	V/1000 min ⁻¹	159.8	
Winding resistance at 20 °C	R ₁₂	Ohm	0.058	
Winding inductance	L _{12_min}	mH	2.6	
Leakage capacitance of the component	C _{ab}	nF	24.3	
Thermal time constant of winding	T _{th_w}	s	210	
Thermal time constant of motor	T _{th_M}	min	14.8	
Mass	m _{mot}	kg	146	164
Holding brake				
Holding torque	M ₄	Nm	0	280.00
Rated voltage	U _N	V	0	24
Rated current	I _N	A	0	1.70
Maximum connection time	t ₁	ms	0	300
Maximum disconnection time	t ₂	ms	0	350
Fan data				
Rated voltage	U _N	V	400/480	
Rated current	I _N	A	0.21/0.28	
Frequency	f _N	Hz	50/60	
1) For tolerance details refer to chapter 6.4 Tolerances			Latest amendment: 2021-03-12	

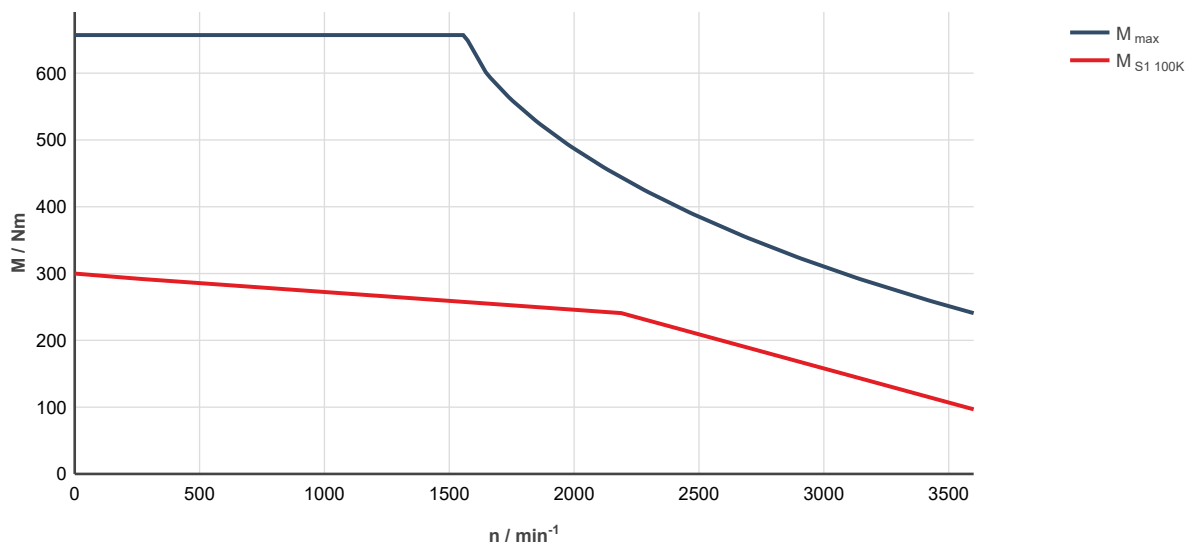

Fig. 330: MS2N13-E1BHC-___0-___-_, ctrlX DRIVE, uncontrolled supply 3 × AC 400 V
 M_{max} Characteristic curve applies to maximum torque 20 °C (cold)

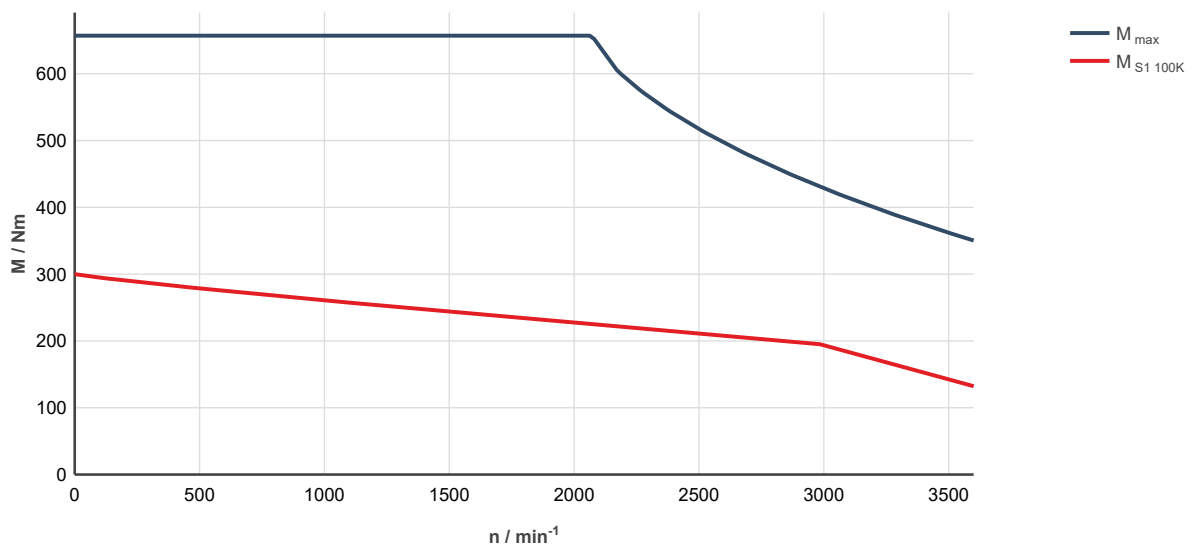

Fig. 331: MS2N13-E1BHC-___0-___-_, ctrlX DRIVE, controlled supply 3 × AC 400 ... 480 V
 M_{max} Characteristic curve applies to maximum torque 20 °C (cold)

MS2N13-E1BNC

Designation	Symbol	Unit	MS2N13-E1BNC-__0-_N	MS2N13-E1BNC-__2-_N
Standstill torque - 100K ¹⁾	M _{0 100K}	Nm	300	
Standstill current - 100K	I _{0 100K}	A	152	
Moment of inertia of rotor ¹⁾	J _{rot}	kg*m ²	0.09	0.1117
Rated speed - 100K	n _{N 100K}	1/min	3,000	
Rated torque - 100K ¹⁾	M _{N 100K}	Nm	130	
Rated current - 100K	I _{N 100K}	A	69.5	
Rated power - 100K ¹⁾	P _{N 100K}	kW	40.8	
Maximum torque 20 °C (cold) ¹⁾	M _{max 20°C}	Nm	692	
Maximum torque 100K (warm) ¹⁾	M _{max 100K}	Nm	657	
Maximum current	I _{max(eff)}	A	400	
Maximum speed (electrical)	n _{max el}	1/min	3600	
Maximum speed (mechanical)	n _{max mech}	1/min	3600	
Number of pole pairs	p		3	
Torque constant at 20 °C ¹⁾	K _m	Nm/A	1.83	
Voltage constant at 20 °C ¹⁾	K _E	V/1000 min ⁻¹	122.4	
Winding resistance at 20 °C	R ₁₂	Ohm	0.033	
Winding inductance	L _{12_min}	mH	1.5	
Leakage capacitance of the component	C _{ab}	nF	21.8	
Thermal time constant of winding	T _{th_w}	s	210	
Thermal time constant of motor	T _{th_M}	min	14.8	
Mass	m _{mot}	kg	146	164
Holding brake				
Holding torque	M ₄	Nm	0	280.00
Rated voltage	U _N	V	0	24
Rated current	I _N	A	0	1.70
Maximum connection time	t ₁	ms	0	300
Maximum disconnection time	t ₂	ms	0	350
Fan data				
Rated voltage	U _N	V	400/480	
Rated current	I _N	A	0.21/0.28	
Frequency	f _N	Hz	50/60	
1) For tolerance details refer to chapter 6.4 Tolerances			Latest amendment: 2020-11-02	

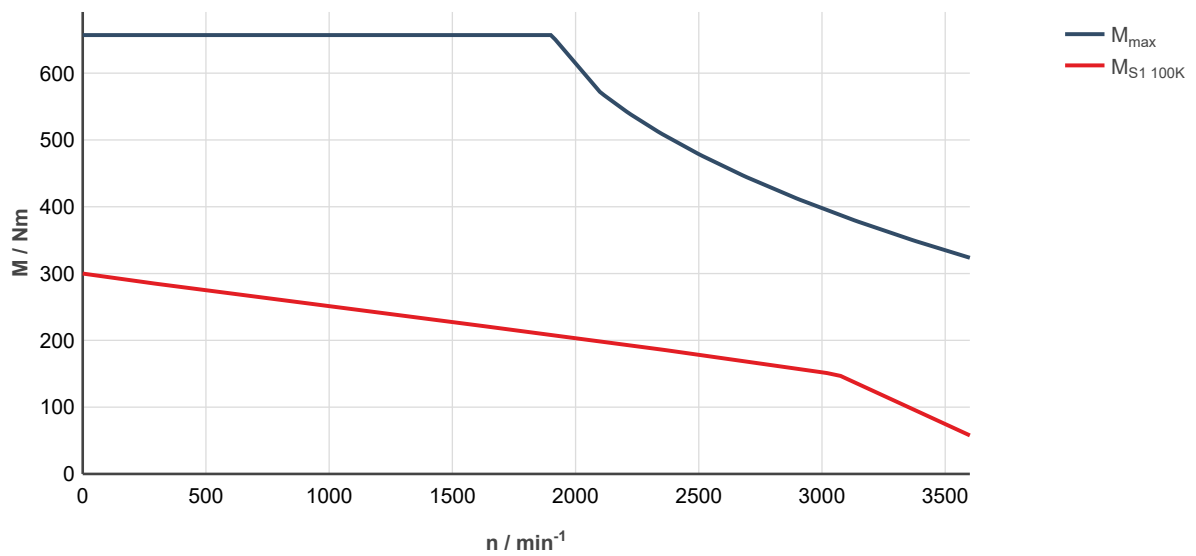

Fig. 332: MS2N13-E1BNC-___0-___-_, ctrIX DRIVE, uncontrolled supply 3 x AC 400 V
 M_{max} Characteristic curve applies to maximum torque 20 °C (cold)

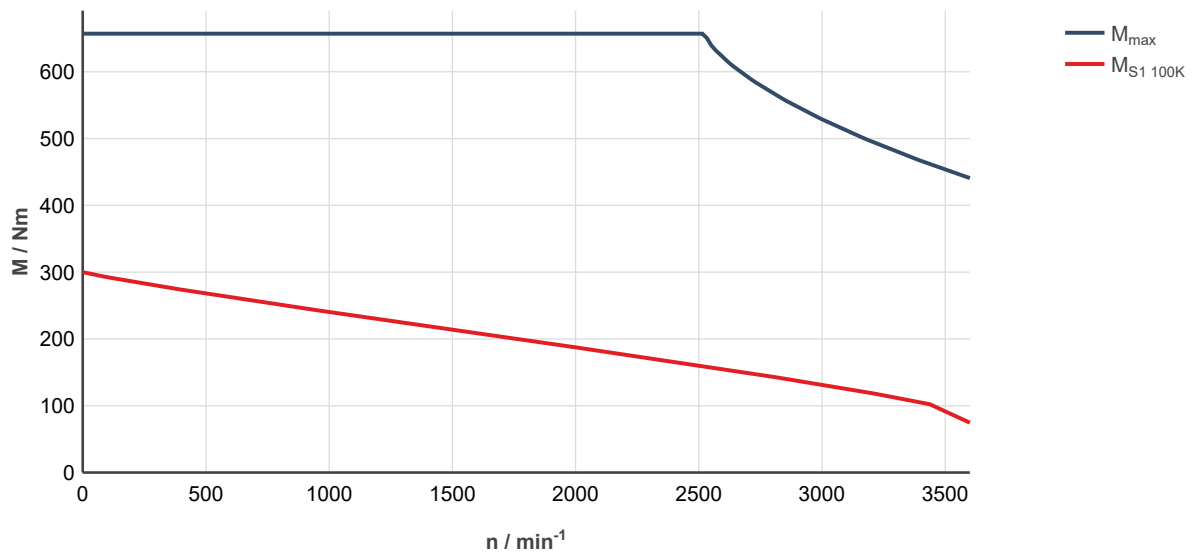

Fig. 333: MS2N13-E1BNC-___0-___-_, ctrIX DRIVE, controlled supply 3 x AC 400 ... 480 V
 M_{max} Characteristic curve applies to maximum torque 20 °C (cold)

7.7.3 Water cooling

MS2N13-B1BHL

Designation	Symbol	Unit	MS2N13-B1BHL-__0	MS2N13-B1BHL-__1
Standstill torque - 100K ¹⁾	M _{0 100K}	Nm	176	
Standstill current - 100K	I _{0 100K}	A	72.5	
Moment of inertia of rotor ¹⁾	J _{rot}	kg*m ²	0.0476	0.055
Rated speed - 100K	n _{N 100K}	1/min	2,000	
Rated torque - 100K ¹⁾	M _{N 100K}	Nm	158.5	
Rated current - 100K	I _{N 100K}	A	66.8	
Rated power - 100K ¹⁾	P _{N 100K}	kW	33.2	
Maximum torque 20 °C (cold) ¹⁾	M _{max 20°C}	Nm	322	
Maximum torque 100K (warm) ¹⁾	M _{max 100K}	Nm	306	
Maximum current	I _{max(eff)}	A	160	
Maximum speed (electrical)	n _{max el}	1/min	3600	
Maximum speed (mechanical)	n _{max mech}	1/min	3600	
Number of pole pairs	p		3	
Torque constant at 20 °C ¹⁾	K _m	Nm/A	2.52	
Voltage constant at 20 °C ¹⁾	K _E	V/1000 min ⁻¹	154	
Winding resistance at 20 °C	R ₁₂	Ohm	0.145	
Winding inductance	L _{12,min}	mH	5.6	
Leakage capacitance of the component	C _{ab}	nF	11.3	
Thermal time constant of winding	T _{th,W}	s	260	
Thermal time constant of motor	T _{th,M}	min	9	
Mass	m _{mot}	kg	88	94
Holding brake				
Holding torque	M ₄	Nm	0	115.00
Rated voltage	U _N	V	0	24
Rated current	I _N	A	0	2.10
Maximum connection time	t ₁	ms	0	100
Maximum disconnection time	t ₂	ms	0	240
Water cooling				
Power loss	P _V	kW	2.1	
Coolant inlet temperature	T _{in}	°C	10...40	
Allowed coolant-temperature for P _V	ΔT _{max}	K	8	
Required coolant flow for P _V	Q _{min}	l/min	4.0	
Pressure drop at Q _{min}	Δp	bar	< 0.6	
Maximum permissible inlet pressure	p _{max}	bar	6.0	
Volume of coolant duct	V _{cool}	l	0.148	
Material of coolant duct			Stainless steel	
1) For tolerance details refer to chapter 6.4 Tolerances			Latest amendment: 2022-05-19	

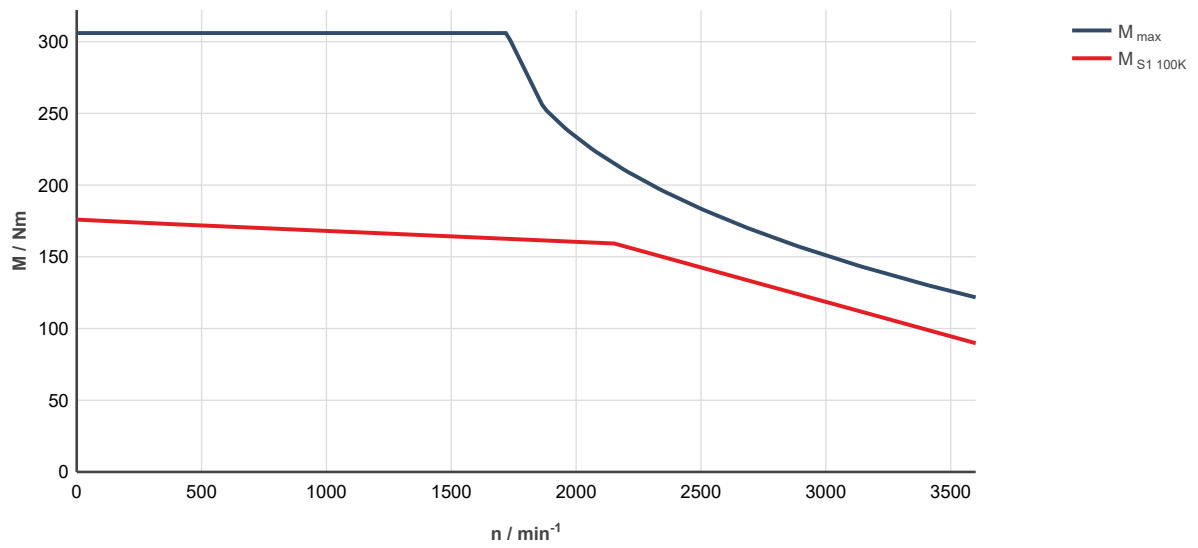

Fig. 334: MS2N13-B1BHL-__0-__-__, ctrlX DRIVE, uncontrolled supply 3 × AC 400 V

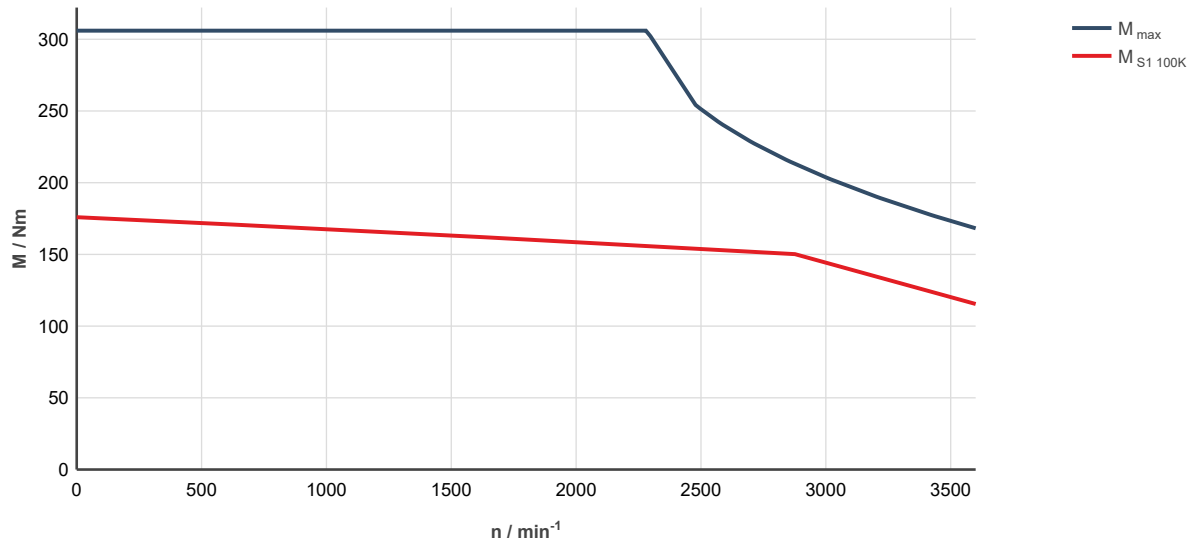

Fig. 335: MS2N13-B1BHL-__0-__-__, ctrlX DRIVE, controlled supply 3 x AC 400 ... 480 V

MS2N13-B1BNL

Designation	Symbol	Unit	MS2N13-B1BNL-__0	MS2N13-B1BNL-__1
Standstill torque - 100K ¹⁾	$M_{0\ 100K}$	Nm	176	
Standstill current - 100K	$I_{0\ 100K}$	A	100	
Moment of inertia of rotor ¹⁾	J_{rot}	kg*m ²	0.0476	0.055
Rated speed - 100K	$n_{N\ 100K}$	1/min	2750	
Rated torque - 100K ¹⁾	$M_{N\ 100K}$	Nm	129.9	
Rated current - 100K	$I_{N\ 100K}$	A	76.8	
Rated power - 100K ¹⁾	$P_{N\ 100K}$	kW	37.4	
Maximum torque 20 °C (cold) ¹⁾	$M_{max\ 20°C}$	Nm	322	
Maximum torque 100K (warm) ¹⁾	$M_{max\ 100K}$	Nm	306	
Maximum current	$I_{max(eff)}$	A	220	
Maximum speed (electrical)	$n_{max\ el}$	1/min	3600	
Maximum speed (mechanical)	$n_{max\ mech}$	1/min	3600	
Number of pole pairs	p		3	
Torque constant at 20 °C ¹⁾	K_m	Nm/A	1.81	
Voltage constant at 20 °C ¹⁾	K_E	V/1000 min ⁻¹	112	
Winding resistance at 20 °C	R_{12}	Ohm	0.08	
Winding inductance	L_{12_min}	mH	3.0	
Leakage capacitance of the component	C_{ab}	nF	10.1	
Thermal time constant of winding	T_{th_W}	s	260	
Thermal time constant of motor	T_{th_M}	min	9	
Mass	m_{mot}	kg	88	94
Holding brake				
Holding torque	M_4	Nm	0	115.00
Rated voltage	U_N	V	0	24
Rated current	I_N	A	0	2.10
Maximum connection time	t_1	ms	0	100
Maximum disconnection time	t_2	ms	0	240
Water cooling				
Power loss	P_V	kW	2.1	
Coolant inlet temperature	T_{in}	°C	10...40	
Allowed coolant-temperature for P_V	ΔT_{max}	K	8	
Required coolant flow for P_V	Q_{min}	l/min	4.0	
Pressure drop at Q_{min}	Δp	bar	< 0.6	
Maximum permissible inlet pressure	p_{max}	bar	6.0	
Volume of coolant duct	V_{cool}	l	0.148	
Material of coolant duct			Stainless steel	
1) For tolerance details refer to chapter 6.4 Tolerances			Latest amendment: 2022-05-19	

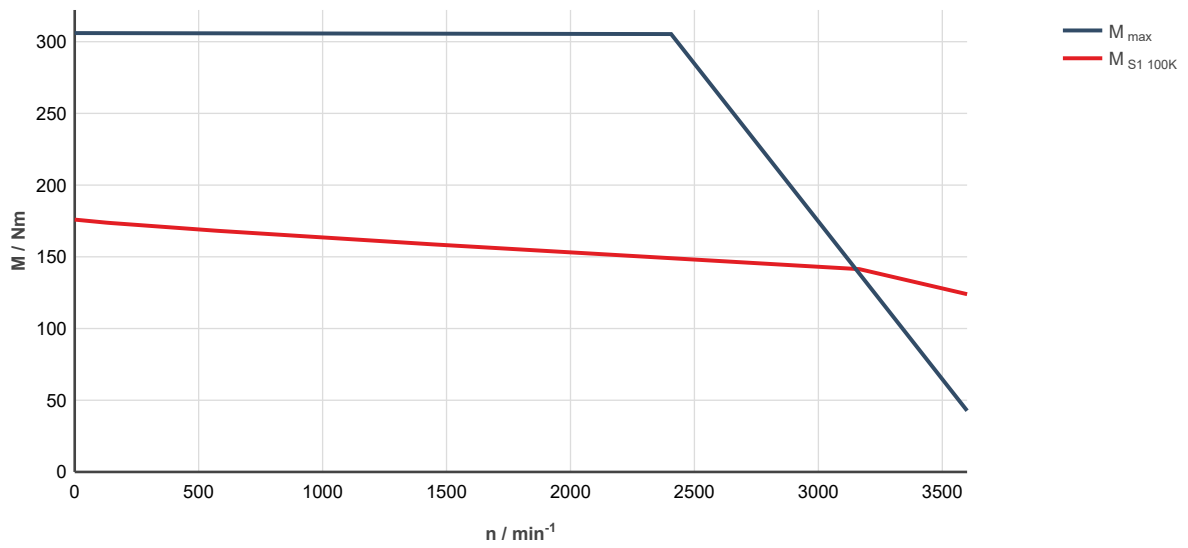

Fig. 336: MS2N13-B1BNL-___0-___-__, ctrlX DRIVE, uncontrolled supply 3 × AC 400 V

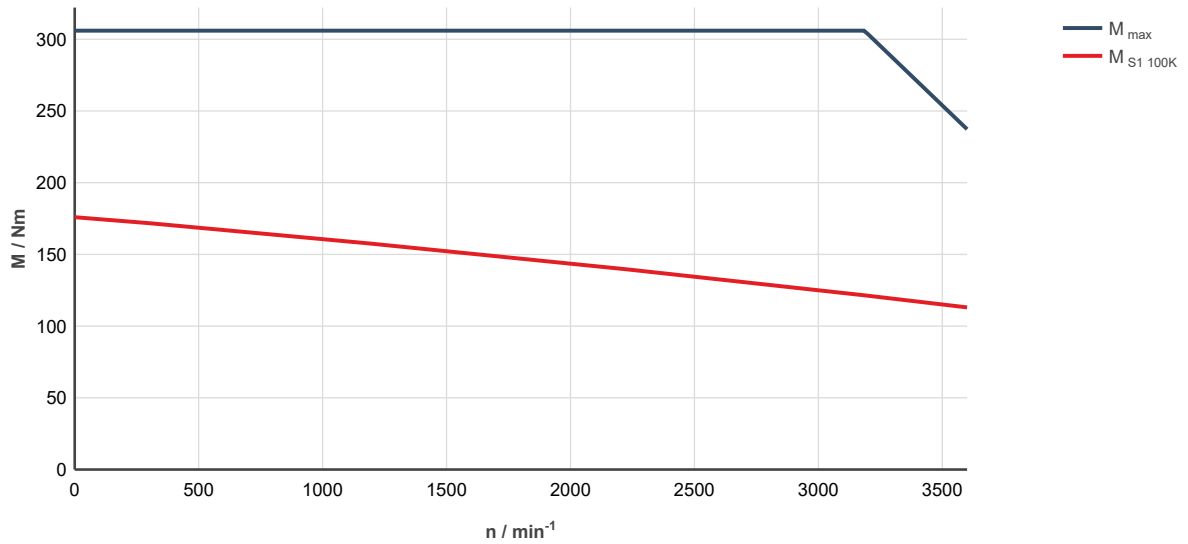

Fig. 337: MS2N13-B1BNL-___0-___-__, ctrlX DRIVE, controlled supply 3 x AC 400 ... 480 V

MS2N13-C1BHL

Designation	Symbol	Unit	MS2N13-C1BHL-__0-N	MS2N13-C1BHL-__1-N
Standstill torque - 100K ¹⁾	M _{0 100K}	Nm	238	
Standstill current - 100K	I _{0 100K}	A	98	
Moment of inertia of rotor ¹⁾	J _{rot}	kg*m ²	0.0618	0.0692
Rated speed - 100K	n _{N 100K}	1/min	2,000	
Rated torque - 100K ¹⁾	M _{N 100K}	Nm	212	
Rated current - 100K	I _{N 100K}	A	89	
Rated power - 100K ¹⁾	P _{N 100K}	kW	44.4	
Maximum torque 20 °C (cold) ¹⁾	M _{max 20°C}	Nm	420	
Maximum torque 100K (warm) ¹⁾	M _{max 100K}	Nm	400	
Maximum current	I _{max(eff)}	A	205	
Maximum speed (electrical)	n _{max el}	1/min	3600	
Maximum speed (mechanical)	n _{max mech}	1/min	3600	
Number of pole pairs	p		3	
Torque constant at 20 °C ¹⁾	K _m	Nm/A	2.54	
Voltage constant at 20 °C ¹⁾	K _E	V/1000 min ⁻¹	155.3	
Winding resistance at 20 °C	R ₁₂	Ohm	0.097	
Winding inductance	L _{12,min}	mH	3.8	
Leakage capacitance of the component	C _{ab}	nF	13	
Thermal time constant of winding	T _{th,W}	s	220	
Thermal time constant of motor	T _{th,M}	min	10	
Mass	m _{mot}	kg	102	108
Holding brake				
Holding torque	M ₄	Nm	0	115.00
Rated voltage	U _N	V	0	24
Rated current	I _N	A	0	2.10
Maximum connection time	t ₁	ms	0	100
Maximum disconnection time	t ₂	ms	0	240
Water cooling				
Power loss	P _V	kW	2.6	
Coolant inlet temperature	T _{in}	°C	10...40	
Allowed coolant-temperature for P _V	ΔT _{max}	K	8	
Required coolant flow for P _V	Q _{min}	l/min	5.0	
Pressure drop at Q _{min}	Δp	bar	< 0.75	
Maximum permissible inlet pressure	p _{max}	bar	6.0	
Volume of coolant duct	V _{cool}	l	0.178	
Material of coolant duct			Stainless steel	
1) For tolerance details refer to chapter 6.4 Tolerances			Latest amendment: 2022-05-19	

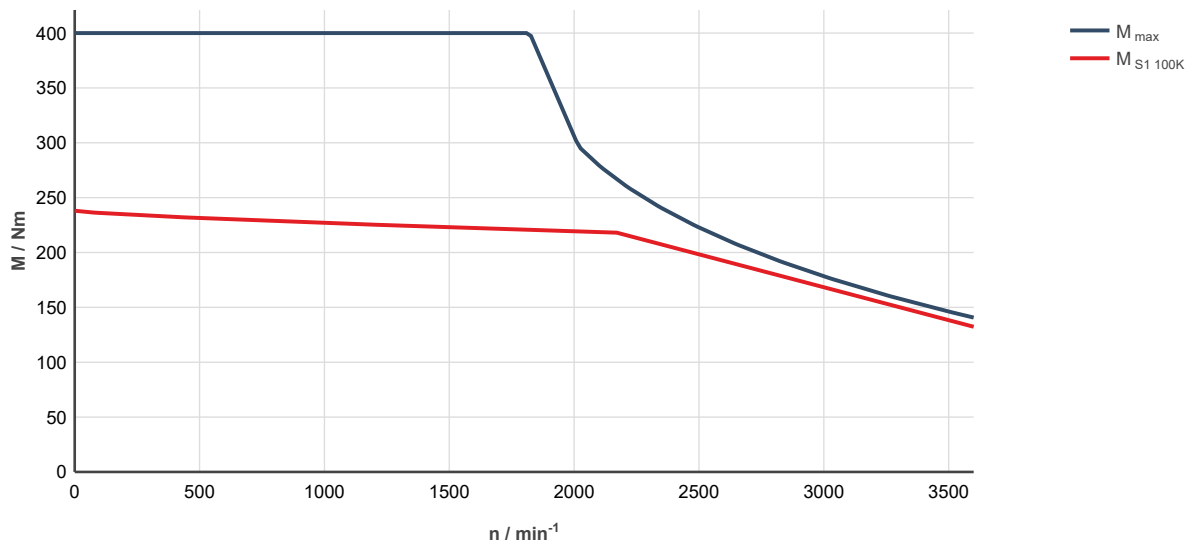

Fig. 338: MS2N13-C1BHL-___0-___-__, ctrlX DRIVE, uncontrolled supply 3 × AC 400 V
 M_{max} Characteristic curve applies to maximum torque 20 °C (cold)

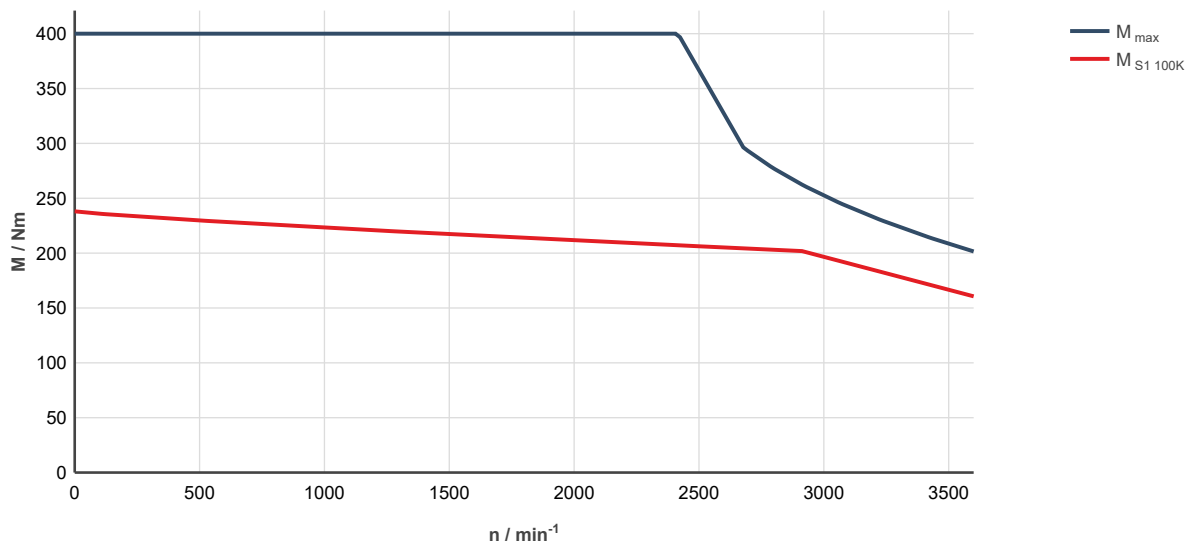

Fig. 339: MS2N13-C1BHL-___0-___-__, ctrlX DRIVE, controlled supply 3 × AC 400 ... 480 V
 M_{max} Characteristic curve applies to maximum torque 20 °C (cold)

MS2N13-C1BNL

Designation	Symbol	Unit	MS2N13-C1BNL-__0	MS2N13-C1BNL-__1
Standstill torque - 100K ¹⁾	M _{0 100K}	Nm	238	
Standstill current - 100K	I _{0 100K}	A	127.5	
Moment of inertia of rotor ¹⁾	J _{rot}	kg*m ²	0.0618	0.0692
Rated speed - 100K	n _{N 100K}	1/min	2750	
Rated torque - 100K ¹⁾	M _{N 100K}	Nm	175	
Rated current - 100K	I _{N 100K}	A	99	
Rated power - 100K ¹⁾	P _{N 100K}	kW	51.8	
Maximum torque 20 °C (cold) ¹⁾	M _{max 20°C}	Nm	421	
Maximum torque 100K (warm) ¹⁾	M _{max 100K}	Nm	400	
Maximum current	I _{max(eff)}	A	270	
Maximum speed (electrical)	n _{max el}	1/min	3600	
Maximum speed (mechanical)	n _{max mech}	1/min	3600	
Number of pole pairs	p		3	
Torque constant at 20 °C ¹⁾	K _m	Nm/A	1.93	
Voltage constant at 20 °C ¹⁾	K _E	V/1000 min ⁻¹	119	
Winding resistance at 20 °C	R ₁₂	Ohm	0.059	
Winding inductance	L _{12_min}	mH	2.5	
Leakage capacitance of the component	C _{ab}	nF	13	
Thermal time constant of winding	T _{th_W}	s	220	
Thermal time constant of motor	T _{th_M}	min	10	
Mass	m _{mot}	kg	102	108
Holding brake				
Holding torque	M ₄	Nm	0	115.00
Rated voltage	U _N	V	0	24
Rated current	I _N	A	0	2.10
Maximum connection time	t ₁	ms	0	100
Maximum disconnection time	t ₂	ms	0	240
Water cooling				
Power loss	P _V	kW	2.6	
Coolant inlet temperature	T _{in}	°C	10...40	
Allowed coolant-temperature for P _V	ΔT _{max}	K	8	
Required coolant flow for P _V	Q _{min}	l/min	5.0	
Pressure drop at Q _{min}	Δp	bar	< 0.75	
Maximum permissible inlet pressure	p _{max}	bar	6.0	
Volume of coolant duct	V _{cool}	l	0.178	
Material of coolant duct			Stainless steel	
1) For tolerance details refer to chapter 6.4 Tolerances			Latest amendment: 2022-05-19	

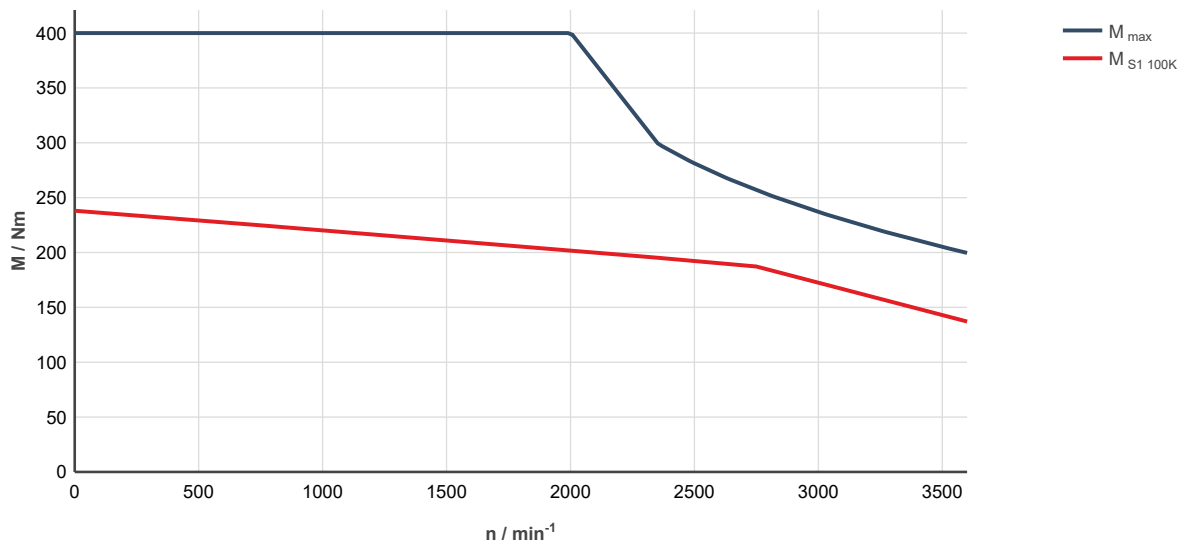

Fig. 340: MS2N13-C1BNL-___0-___-___, ctrIX DRIVE, uncontrolled supply 3 × AC 400 V

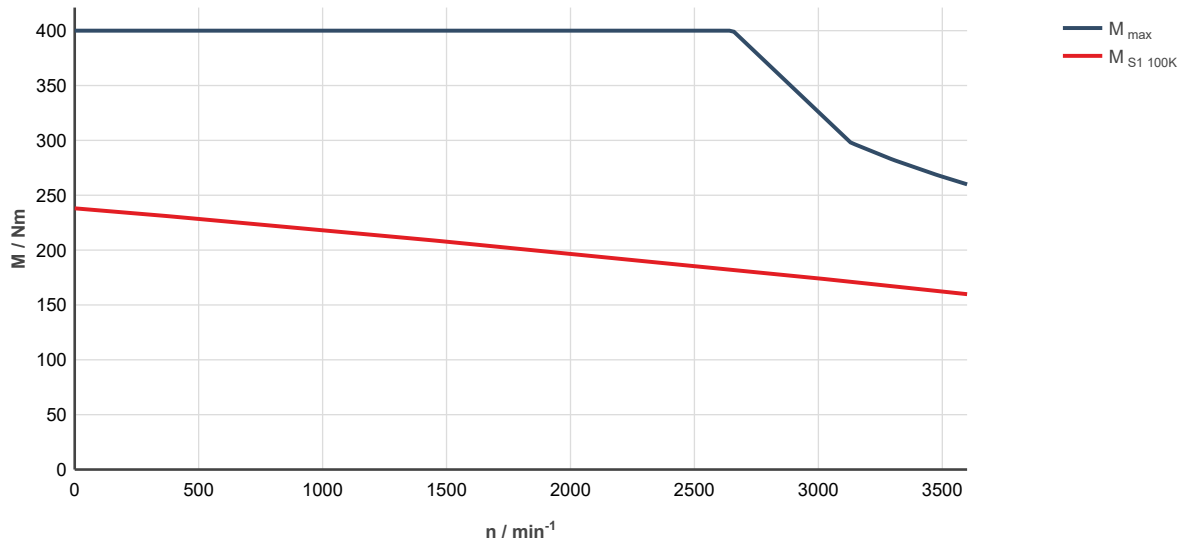

Fig. 341: MS2N13-C1BNL-___0-___-___, ctrIX DRIVE, controlled supply 3 x AC 400 ... 480 V

MS2N13-D1BHL

Designation	Symbol	Unit	MS2N13-D1BHL-__0-N	MS2N13-D1BHL-__1-N
Standstill torque - 100K ¹⁾	M _{0 100K}	Nm	295	
Standstill current - 100K	I _{0 100K}	A	122	
Moment of inertia of rotor ¹⁾	J _{rot}	kg*m ²	0.078	0.0833
Rated speed - 100K	n _{N 100K}	1/min	2,000	
Rated torque - 100K ¹⁾	M _{N 100K}	Nm	262	
Rated current - 100K	I _{N 100K}	A	110	
Rated power - 100K ¹⁾	P _{N 100K}	kW	54.9	
Maximum torque 20 °C (cold) ¹⁾	M _{max 20°C}	Nm	540	
Maximum torque 100K (warm) ¹⁾	M _{max 100K}	Nm	512	
Maximum current	I _{max(eff)}	A	265	
Maximum speed (electrical)	n _{max el}	1/min	3600	
Maximum speed (mechanical)	n _{max mech}	1/min	3600	
Number of pole pairs	p		3	
Torque constant at 20 °C ¹⁾	K _m	Nm/A	2.56	
Voltage constant at 20 °C ¹⁾	K _E	V/1000 min ⁻¹	156	
Winding resistance at 20 °C	R ₁₂	Ohm	0.072	
Winding inductance	L _{12,min}	mH	3.4	
Leakage capacitance of the component	C _{ab}	nF	16.35	
Thermal time constant of winding	T _{th,W}	s	240	
Thermal time constant of motor	T _{th,M}	min	9	
Mass	m _{mot}	kg	121	127
Holding brake				
Holding torque	M ₄	Nm	0	115.00
Rated voltage	U _N	V	0	24
Rated current	I _N	A	0	2.10
Maximum connection time	t ₁	ms	0	100
Maximum disconnection time	t ₂	ms	0	240
Water cooling				
Power loss	P _V	kW	3.1	
Coolant inlet temperature	T _{in}	°C	10...40	
Allowed coolant-temperature for P _V	ΔT _{max}	K	8	
Required coolant flow for P _V	Q _{min}	l/min	6	
Pressure drop at Q _{min}	Δp	bar	< 0.9	
Maximum permissible inlet pressure	p _{max}	bar	6.0	
Volume of coolant duct	V _{cool}	l	0.208	
Material of coolant duct			Stainless steel	
1) For tolerance details refer to chapter 6.4 Tolerances			Latest amendment: 2021-03-24	

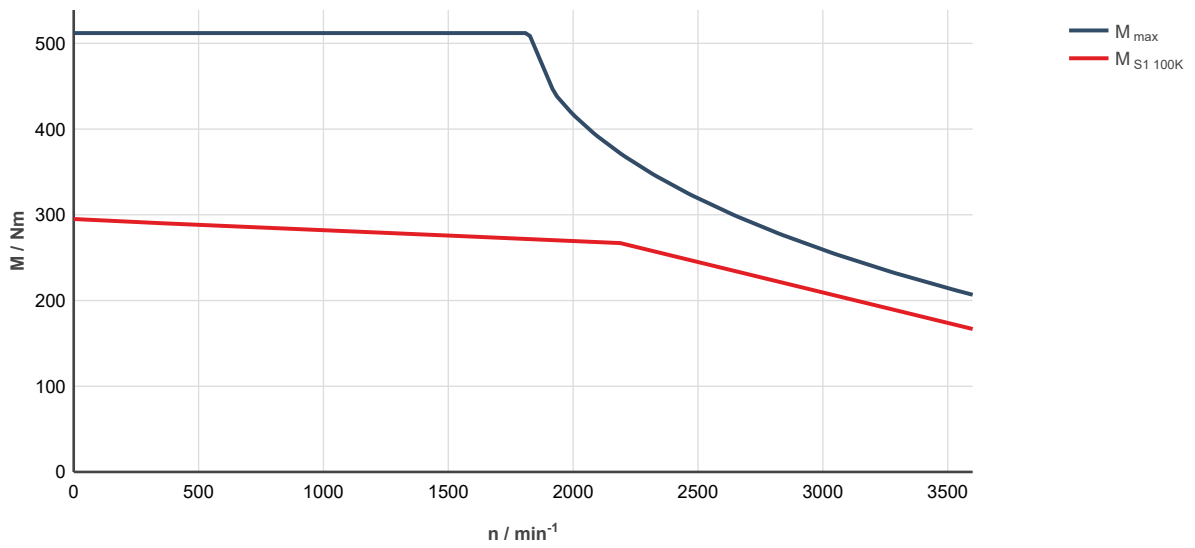

Fig. 342: MS2N13-D1BHL-__0-__-__, ctrlX DRIVE, uncontrolled supply 3 × AC 400 V

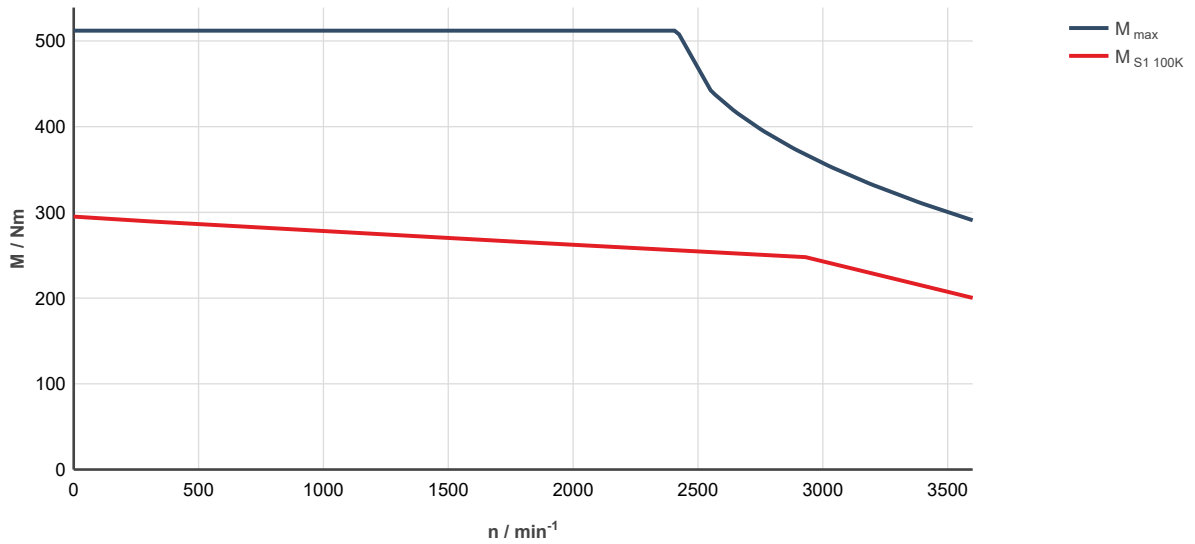

Fig. 343: MS2N13-D1BHL-__0-__-__, ctrlX DRIVE, controlled supply 3 x AC 400 ... 480 V

MS2N13-D1BNL

Designation	Symbol	Unit	MS2N13-D1BNL-__0-N	MS2N13-D1BNL-__1-N
Standstill torque - 100K ¹⁾	M _{0 100K}	Nm	295	
Standstill current - 100K	I _{0 100K}	A	162	
Moment of inertia of rotor ¹⁾	J _{rot}	kg*m ²	0.078	0.0833
Rated speed - 100K	n _{N 100K}	1/min	2750	
Rated torque - 100K ¹⁾	M _{N 100K}	Nm	227.6	
Rated current - 100K	I _{N 100K}	A	126.5	
Rated power - 100K ¹⁾	P _{N 100K}	kW	65.5	
Maximum torque 20 °C (cold) ¹⁾	M _{max 20°C}	Nm	540	
Maximum torque 100K (warm) ¹⁾	M _{max 100K}	Nm	512	
Maximum current	I _{max(eff)}	A	354	
Maximum speed (electrical)	n _{max el}	1/min	3600	
Maximum speed (mechanical)	n _{max mech}	1/min	3600	
Number of pole pairs	p		3	
Torque constant at 20 °C ¹⁾	K _m	Nm/A	1.91	
Voltage constant at 20 °C ¹⁾	K _E	V/1000 min ⁻¹	116.9	
Winding resistance at 20 °C	R ₁₂	Ohm	0.046	
Winding inductance	L _{12,min}	mH	1.9	
Leakage capacitance of the component	C _{ab}	nF	19.5	
Thermal time constant of winding	T _{th,W}	s	240.0	
Thermal time constant of motor	T _{th,M}	min	9.0	
Mass	m _{mot}	kg	121	127
Holding brake				
Holding torque	M ₄	Nm	0	115.00
Rated voltage	U _N	V	0	24
Rated current	I _N	A	0	2.10
Maximum connection time	t ₁	ms	0	100
Maximum disconnection time	t ₂	ms	0	240
Water cooling				
Power loss	P _V	kW	3.15	
Coolant inlet temperature	T _{in}	°C	10...40	
Allowed coolant-temperature for P _V	ΔT _{max}	K	8	
Required coolant flow for P _V	Q _{min}	l/min	6	
Pressure drop at Q _{min}	Δp	bar	< 0.9	
Maximum permissible inlet pressure	p _{max}	bar	6.0	
Volume of coolant duct	V _{cool}	l	0.208	
Material of coolant duct			Stainless steel	
1) For tolerance details refer to chapter 6.4 Tolerances			Latest amendment: 2022-05-04	

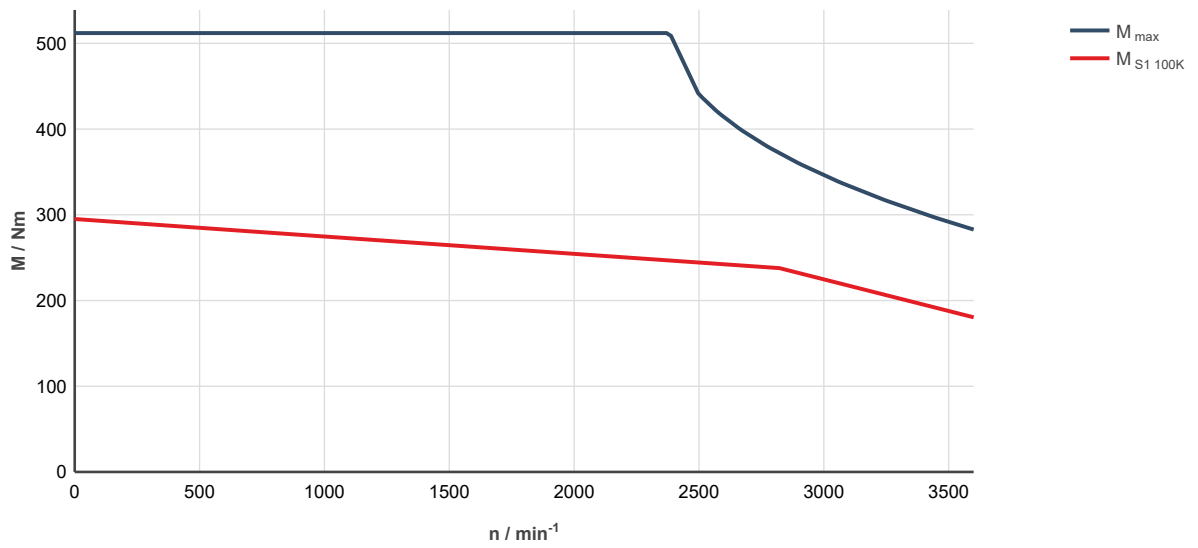

Fig. 344: MS2N13-D1BNL-___0-___-__, ctrlX DRIVE, uncontrolled supply 3 × AC 400 V

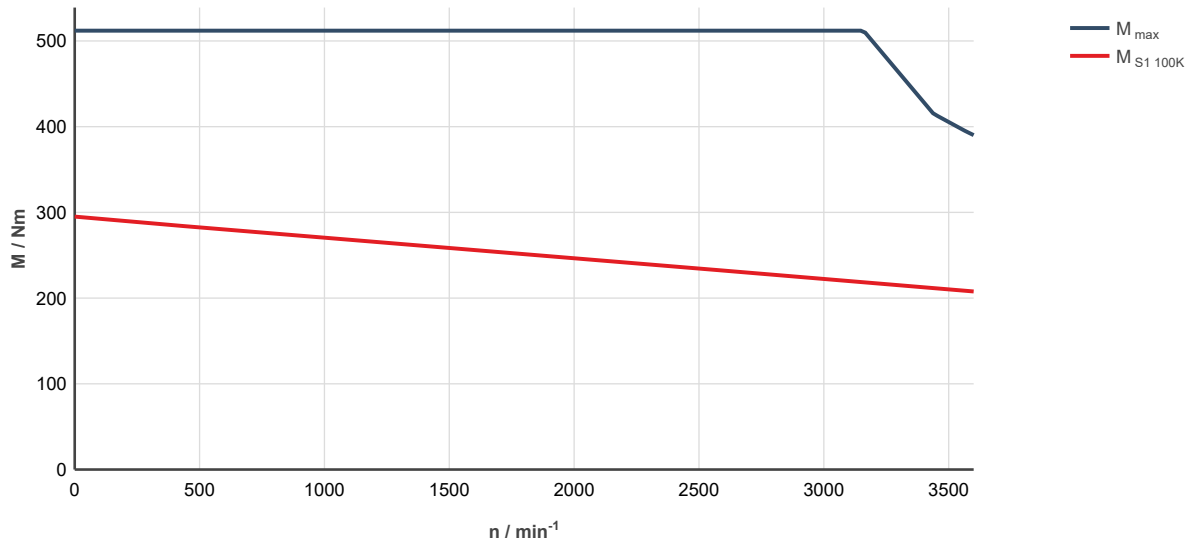

Fig. 345: MS2N13-D1BNL-___0-___-__, ctrlX DRIVE, controlled supply 3 x AC 400 ... 480 V

MS2N13-E1BHL

Designation	Symbol	Unit	MS2N13-E1BHL-__0-N	MS2N13-E1BHL-__1-N
Standstill torque - 100K ¹⁾	$M_{0\ 100K}$	Nm	345	
Standstill current - 100K	$I_{0\ 100K}$	A	138	
Moment of inertia of rotor ¹⁾	J_{rot}	kg*m ²	0.09	0.0974
Rated speed - 100K	$n_{N\ 100K}$	1/min	2,000	
Rated torque - 100K ¹⁾	$M_{N\ 100K}$	Nm	297	
Rated current - 100K	$I_{N\ 100K}$	A	121	
Rated power - 100K ¹⁾	$P_{N\ 100K}$	kW	62.2	
Maximum torque 20 °C (cold) ¹⁾	$M_{max\ 20°C}$	Nm	642	
Maximum torque 100K (warm) ¹⁾	$M_{max\ 100K}$	Nm	610	
Maximum current	$I_{max(eff)}$	A	305	
Maximum speed (electrical)	$n_{max\ el}$	1/min	3600	
Maximum speed (mechanical)	$n_{max\ mech}$	1/min	3600	
Number of pole pairs	p		3	
Torque constant at 20 °C ¹⁾	K_m	Nm/A	2.60	
Voltage constant at 20 °C ¹⁾	K_E	V/1000 min ⁻¹	159.8	
Winding resistance at 20 °C	R_{12}	Ohm	0.058	
Winding inductance	L_{12_min}	mH	2.6	
Leakage capacitance of the component	C_{ab}	nF	24.3	
Thermal time constant of winding	T_{th_W}	s	270	
Thermal time constant of motor	T_{th_M}	min	9	
Mass	m_{mot}	kg	146	152
Holding brake				
Holding torque	M_4	Nm	0	115.00
Rated voltage	U_N	V	0	24
Rated current	I_N	A	0	2.10
Maximum connection time	t_1	ms	0	100
Maximum disconnection time	t_2	ms	0	240
Water cooling				
Power loss	P_V	kW	3.2	
Coolant inlet temperature	T_{in}	°C	10...40	
Allowed coolant-temperature for P_V	ΔT_{max}	K	8	
Required coolant flow for P_V	Q_{min}	l/min	6	
Pressure drop at Q_{min}	Δp	bar	< 1.0	
Maximum permissible inlet pressure	p_{max}	bar	6.0	
Volume of coolant duct	V_{cool}	l	0.238	
Material of coolant duct			Stainless steel	
1) For tolerance details refer to chapter 6.4 Tolerances			Latest amendment: 2021-03-05	

MS2N13-E1BHL-___0-___-___, ctrlX DRIVE, uncontrolled supply 3 × AC 400 V

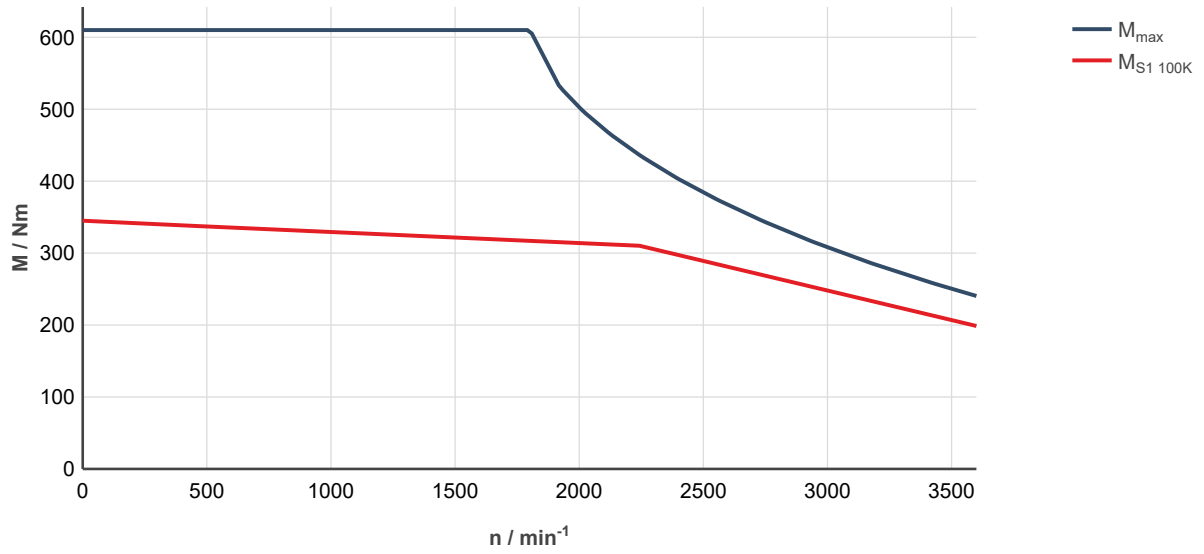

Fig. 346: MS2N13-E1BHL-___0-___-___, ctrlX DRIVE, uncontrolled supply 3 × AC 400 V
 M_{max} Characteristic curve applies to maximum torque 20 °C (cold)

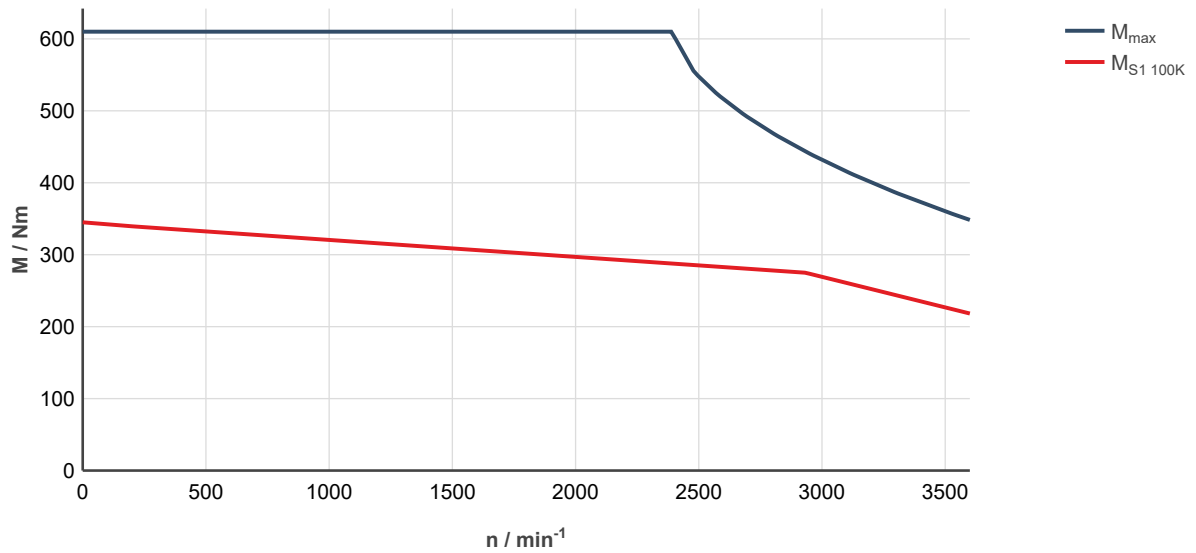

Fig. 347: MS2N13-E1BHL-___0-___-___, ctrlX DRIVE, controlled supply 3 × AC 400 ... 480 V
 M_{max} Characteristic curve applies to maximum torque 20 °C (cold)

MS2N13-E1BNL

Designation	Symbol	Unit	MS2N13-E1BNL-__0-N	MS2N13-E1BNL-__1-N
Standstill torque - 100K ¹⁾	M _{0 100K}	Nm	345	
Standstill current - 100K	I _{0 100K}	A	183	
Moment of inertia of rotor ¹⁾	J _{rot}	kg*m ²	0.09	0.0974
Rated speed - 100K	n _{N 100K}	1/min	2860	
Rated torque - 100K ¹⁾	M _{N 100K}	Nm	270	
Rated current - 100K	I _{N 100K}	A	146	
Rated power - 100K ¹⁾	P _{N 100K}	kW	80.9	
Maximum torque 20 °C (cold) ¹⁾	M _{max 20°C}	Nm	642	
Maximum torque 100K (warm) ¹⁾	M _{max 100K}	Nm	610	
Maximum current	I _{max(eff)}	A	400	
Maximum speed (electrical)	n _{max el}	1/min	3600	
Maximum speed (mechanical)	n _{max mech}	1/min	3600	
Number of pole pairs	p		3	
Torque constant at 20 °C ¹⁾	K _m	Nm/A	1.83	
Voltage constant at 20 °C ¹⁾	K _E	V/1000 min ⁻¹	122.4	
Winding resistance at 20 °C	R ₁₂	Ohm	0.033	
Winding inductance	L _{12,min}	mH	1.5	
Leakage capacitance of the component	C _{ab}	nF	21.8	
Thermal time constant of winding	T _{th,W}	s	270	
Thermal time constant of motor	T _{th,M}	min	9	
Mass	m _{mot}	kg	146	152
Holding brake				
Holding torque	M ₄	Nm	0	115.00
Rated voltage	U _N	V	0	24
Rated current	I _N	A	0	2.10
Maximum connection time	t ₁	ms	0	100
Maximum disconnection time	t ₂	ms	0	240
Water cooling				
Power loss	P _V	kW	3.35	
Coolant inlet temperature	T _{in}	°C	10...40	
Allowed coolant-temperature for P _V	ΔT _{max}	K	8	
Required coolant flow for P _V	Q _{min}	l/min	6	
Pressure drop at Q _{min}	Δp	bar	<1.0	
Maximum permissible inlet pressure	p _{max}	bar	6.0	
Volume of coolant duct	V _{cool}	l	0.238	
Material of coolant duct			Stainless steel	
1) For tolerance details refer to chapter 6.4 Tolerances			Latest amendment: 2020-10-07	

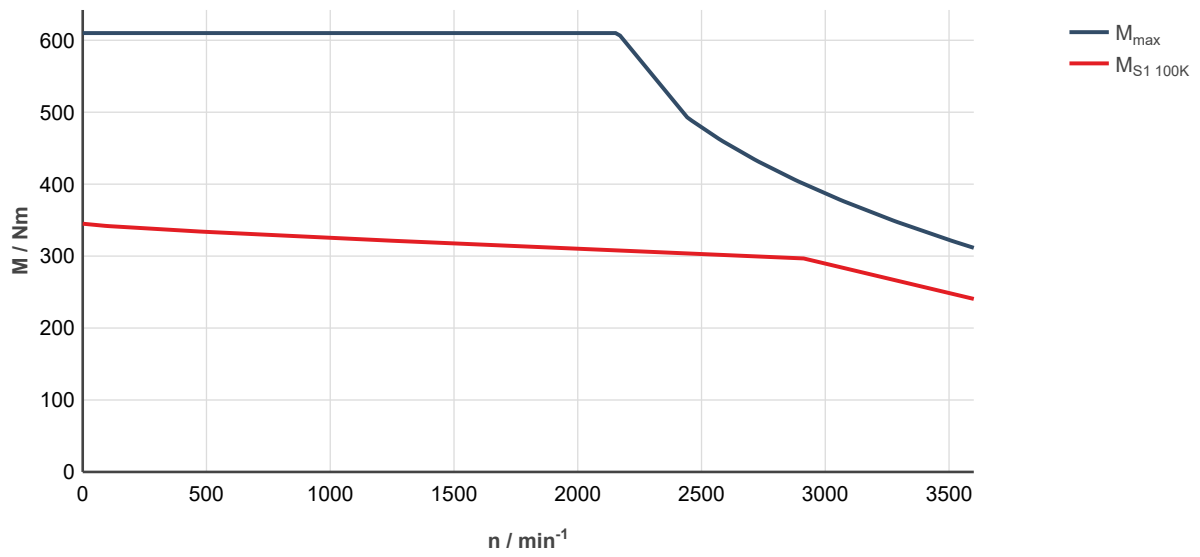

Fig. 348: MS2N13-E1BNL-___0-___-__, ctrlX DRIVE, uncontrolled supply 3 × AC 400 V

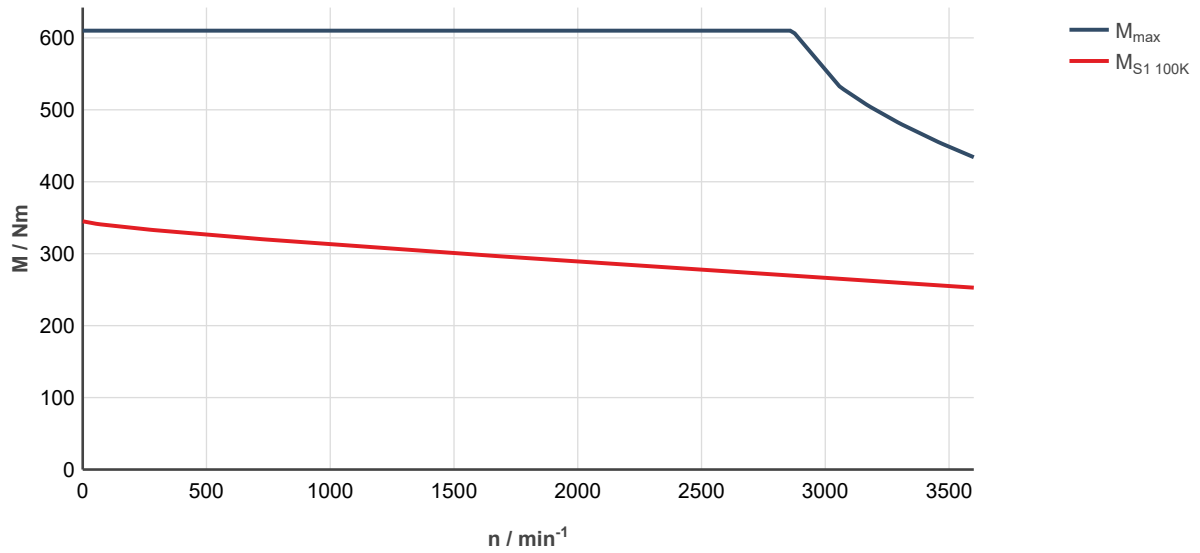
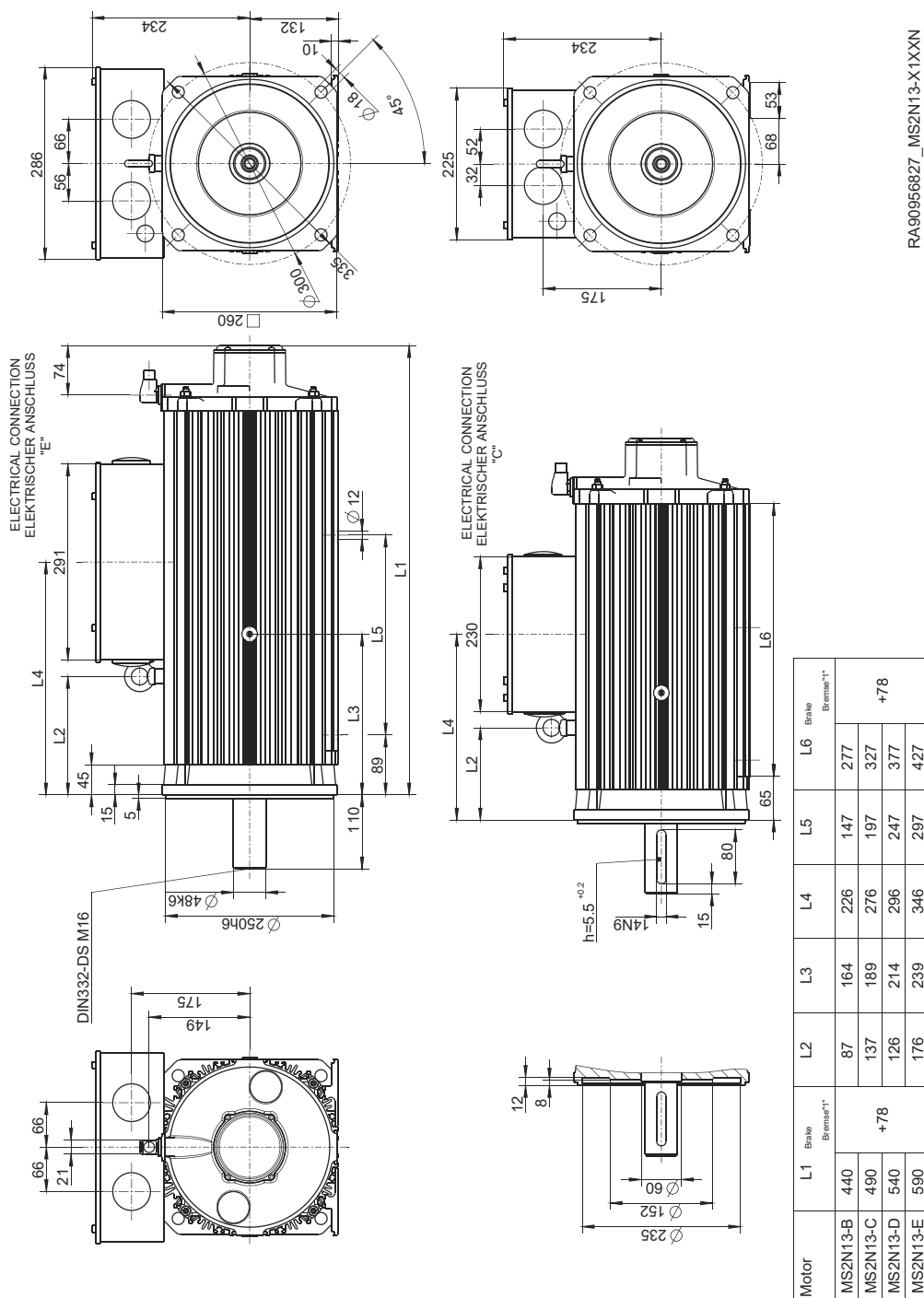

Fig. 349: MS2N13-E1BNL-___0-___-__, ctrlX DRIVE, controlled supply 3 × AC 400 ... 480 V

7.7.4 Specification self-cooling



RA90956827_MS2N13-X1XXN

Fig. 350: MS2N13-X1XXN_AA

7.7.6 Water cooling specification

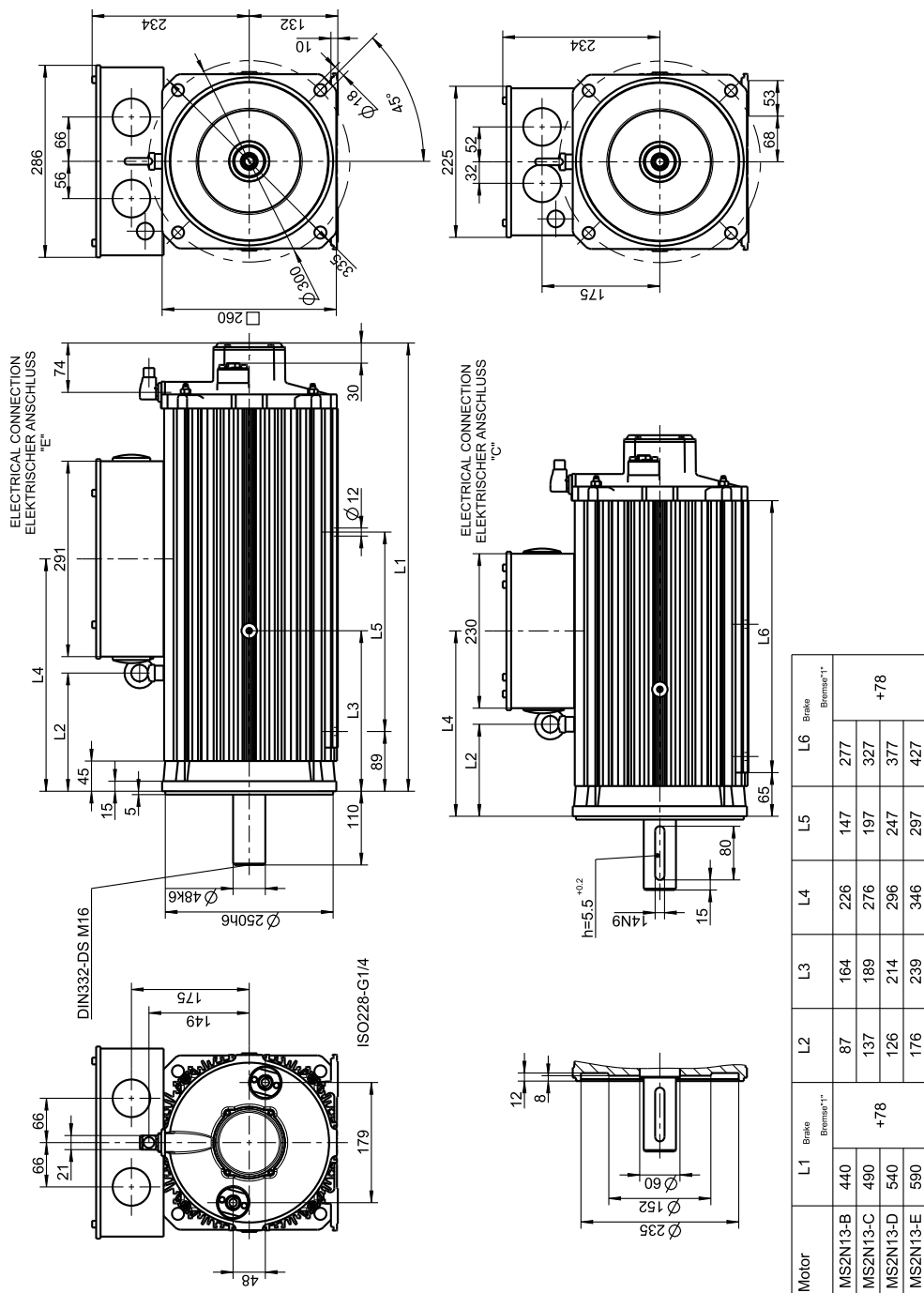

RA76741149_MS2N13-X1XXL_AA

Fig. 352: MS2N13-X1XXL

7.7.7 MS2N13 Axial force

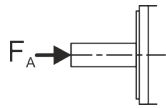

Axial forces F_A are permissible without limitation up to 50 N. Higher axial forces only after a detailed dimensioning by your distribution partner at Bosch Rexroth. For evaluation purposes, please specify the following information:

- Axial and radial force with force application point
- Installation position (horizontal, vertical with the shaft end pointing to the top or bottom)
- Mean speed

7.7.8 MS2N13 Radial force

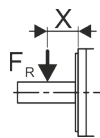

NOTICE

Direction of radial force

For foot mounting, the information in the operating instructions on the force direction must be taken into account.

The permissible radial force F_R is specified in distance x from the shaft shoulder, depending on the mean speed in the following diagram.

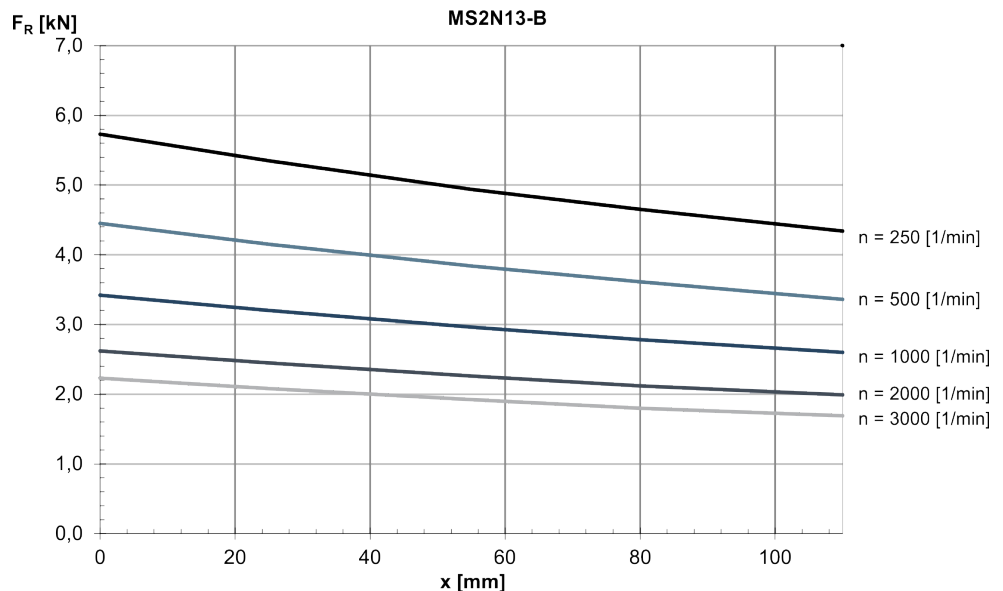

Fig. 353: MS2N13-B: Radial force in distance x from the shaft shoulder at a nominal bearing service life of $L_{h10} = 30000$ h

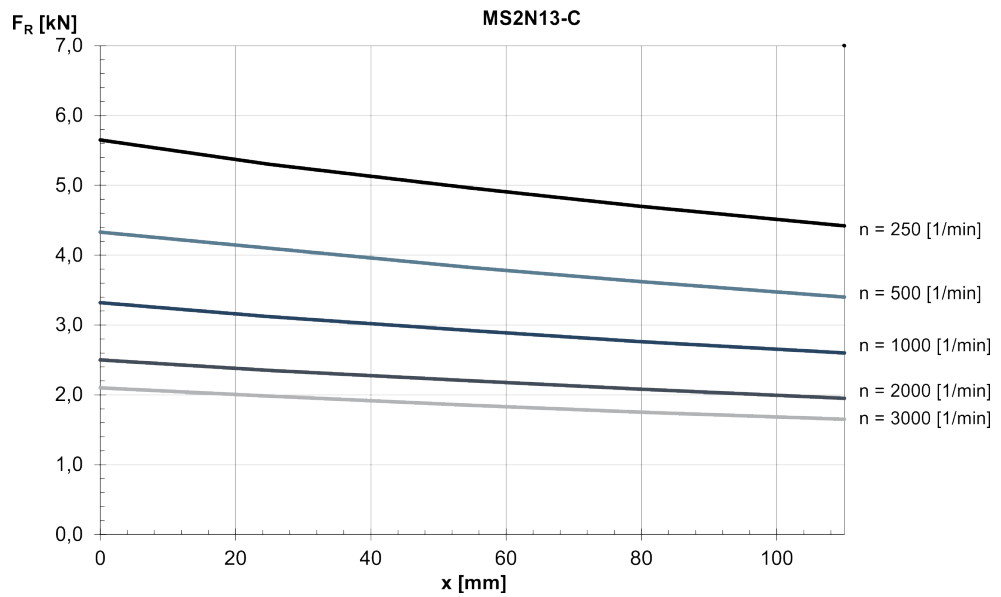

Fig. 354: MS2N13-C: Radial force in distance x from the shaft shoulder at a nominal bearing service life of $L_{h10} = 30000$ h

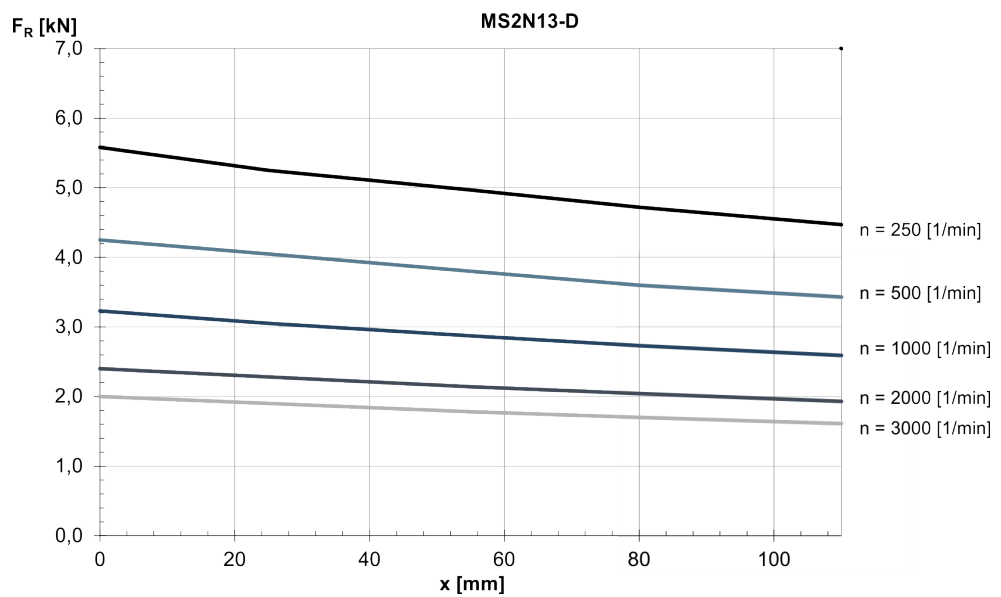

Fig. 355: MS2N13-D: Radial force in distance x from the shaft shoulder at a nominal bearing service life of $L_{h10} = 30000$ h

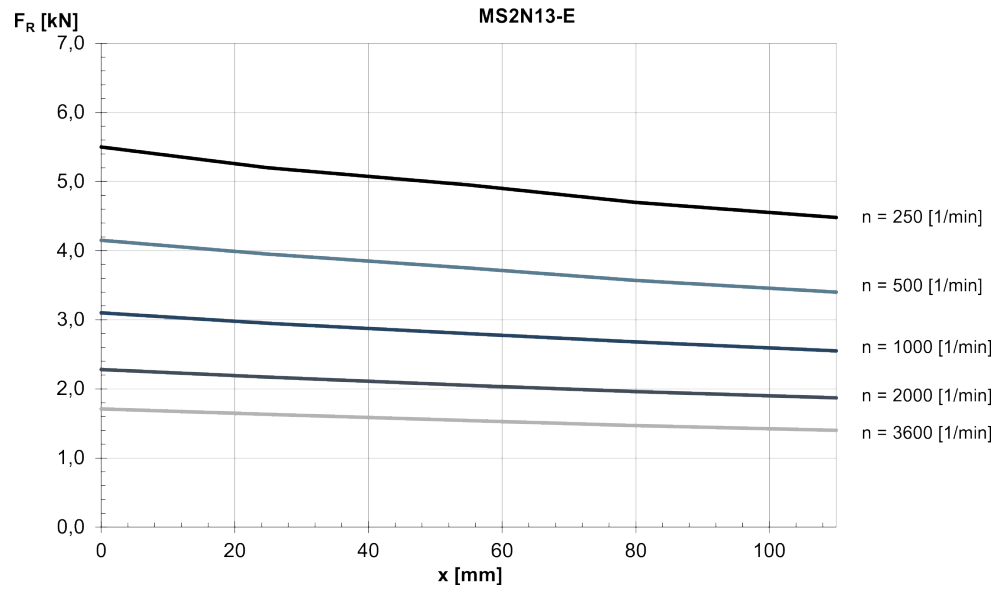

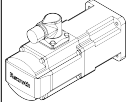
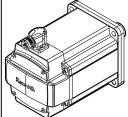
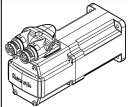
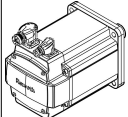
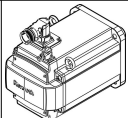

Fig. 356: MS2N13-E: Radial force in distance x from the shaft shoulder at a nominal bearing service life of $L_{h10} = 30000$ h

8 Electrical connection

8.1 Overview of connection variants

The electrical connection of MS2N motors is made via plug connectors or terminal boxes. Depending on the selected options, the following connection variants are available.

Table 20: MS2N Connection system overview

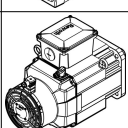
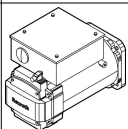
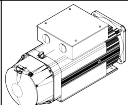
Type	Connection mode	Type of connection/size	Locking	Output direction
MS2Nxx-xxxxx-xxH	 Single cable	M17	Speedtec	rotatable
MS2Nxx-xxxxx-xxS	 Single cable	M23	SpeedCon	rotatable
MS2Nxx-xxxxx-xxD	 Double cable	M17 Power	SpeedCon	rotatable
		M17 Encoder	SpeedCon	rotatable
MS2Nxx-xxxxx-xxU	 Double cable	M23 Power	SpeedCon	rotatable
		M17 Encoder	SpeedCon	rotatable
MS2Nxx-xxxxx-xxV	 Double cable	M40 Power	SpeedCon	rotatable
		M17 Encoder	SpeedCon	rotatable
MS2Nxx-xxxxx-xxA MS2Nxx-xxxxx-xxB	 Double cable	M58 Power	Thread	fixed
		M17 Encoder	SpeedCon	rotatable
MS2Nxx-xxxxx-xxT	 Double cable	Terminal boxes "T" power	Terminal board	fixed
		M17 Encoder	SpeedCon	rotatable
MS2Nxx-xxxxx-xxC	 Double cable	Terminal boxes "C" power	Terminal board	fixed
		M17 Encoder	SpeedCon	rotatable
MS2N13-xxxxx-xxE	 Double cable	Terminal boxes "E" power	Terminal board	fixed
		M17 Encoder	SpeedCon	rotatable

The device connectors can be rotated.

Ready-made connection cables are available for user-friendly connection. Use these cables for a simple, quick and reliable installation. The plug connectors are equipped with quick locks.

In case of force-ventilated motors, connect the fan unit according to the connection diagram.

8.2 Circuit diagram

8.2.1 Single cable connection for MS2N with encoder (digital C, D, H) and optional brake

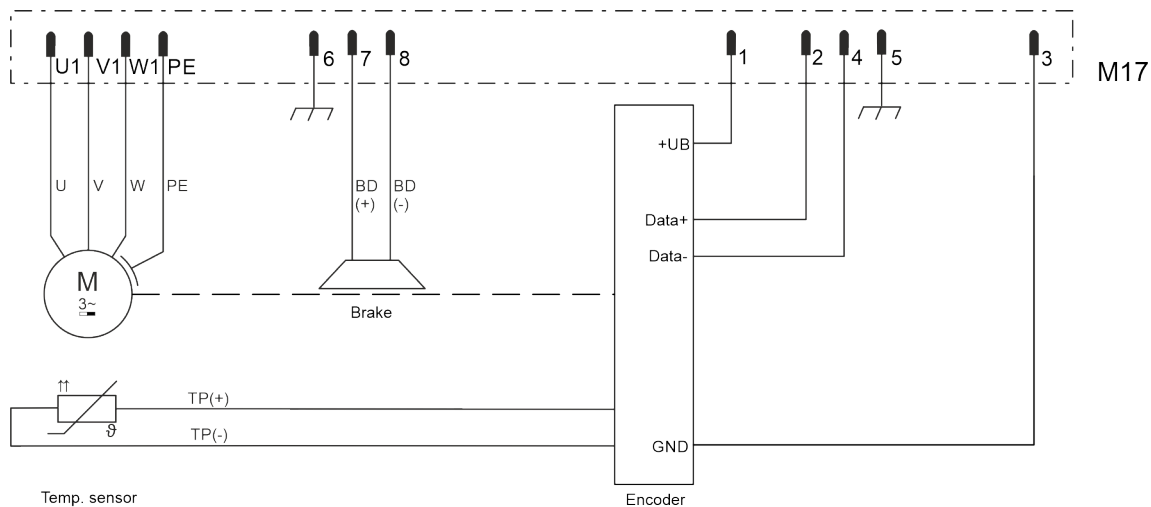

Fig. 357: M17 Single cable connection, digital encoder C, D, H, optional brake

8.2.2 Single cable connection for MS2N with encoder (digital C, D, H) and optional brake

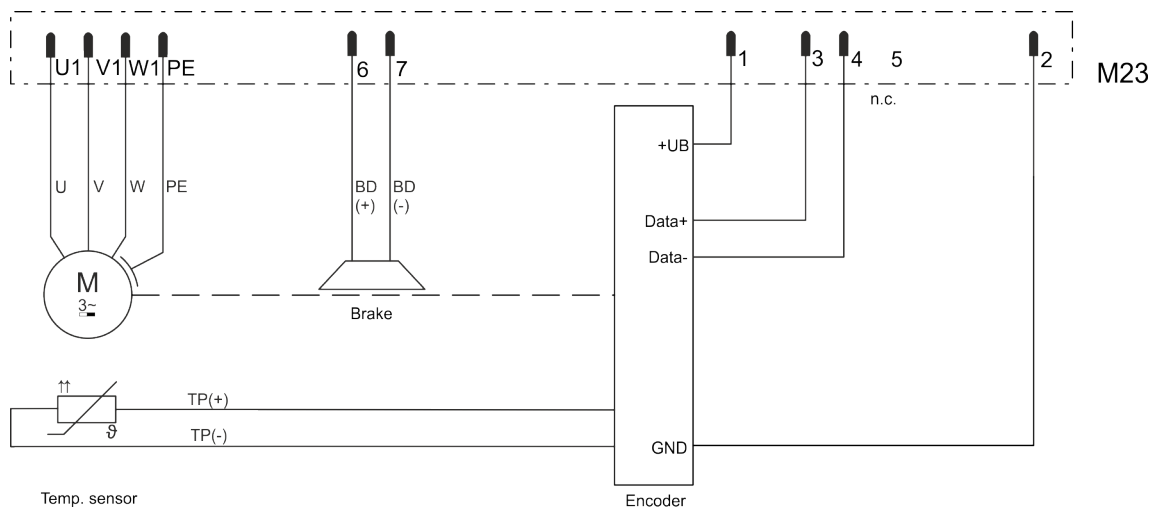

Fig. 358: M23 Single cable connection, digital encoder C, D, H, optional brake

8.2.3 Double cable connection for MS2N with encoder (analog A, B) and optional brake

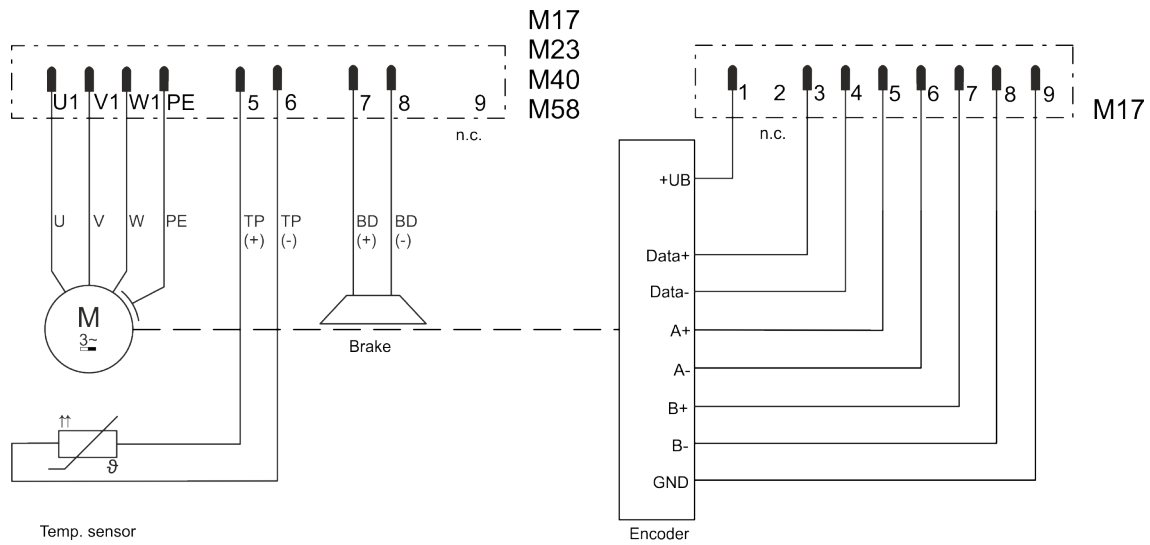

Fig. 359: Double cable connection, analog encoder A, brake optional

8.2.4 Double cable connection terminal box for MS2N with encoder (digital C, D, H) and optional brake

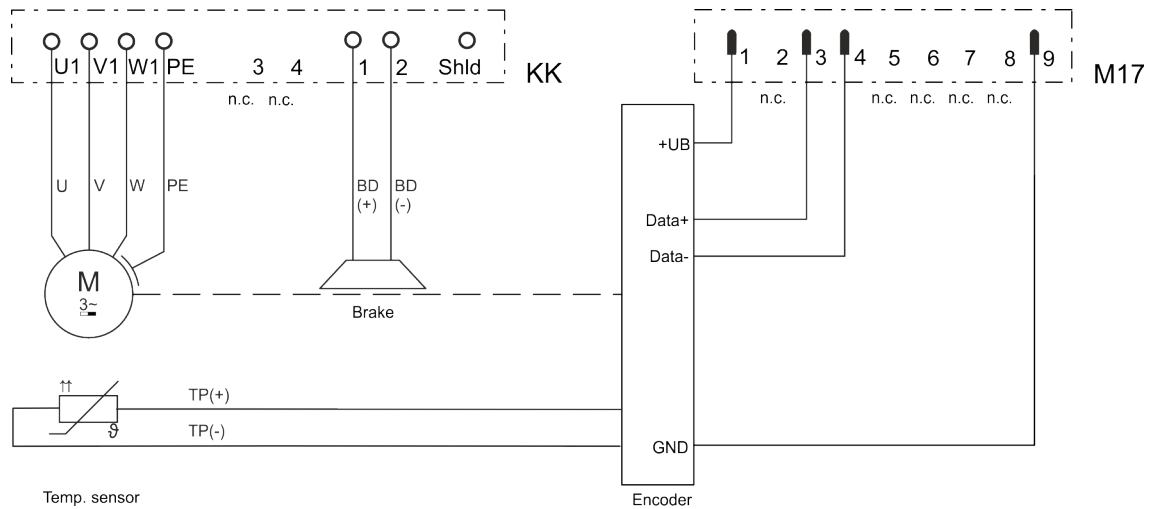

Fig. 360: Double cable connection terminal boxes, digital encoder C and D, brake optional

8.2.5 Double cable connection terminal box for MS2N with encoder (analog A, B) and optional brake

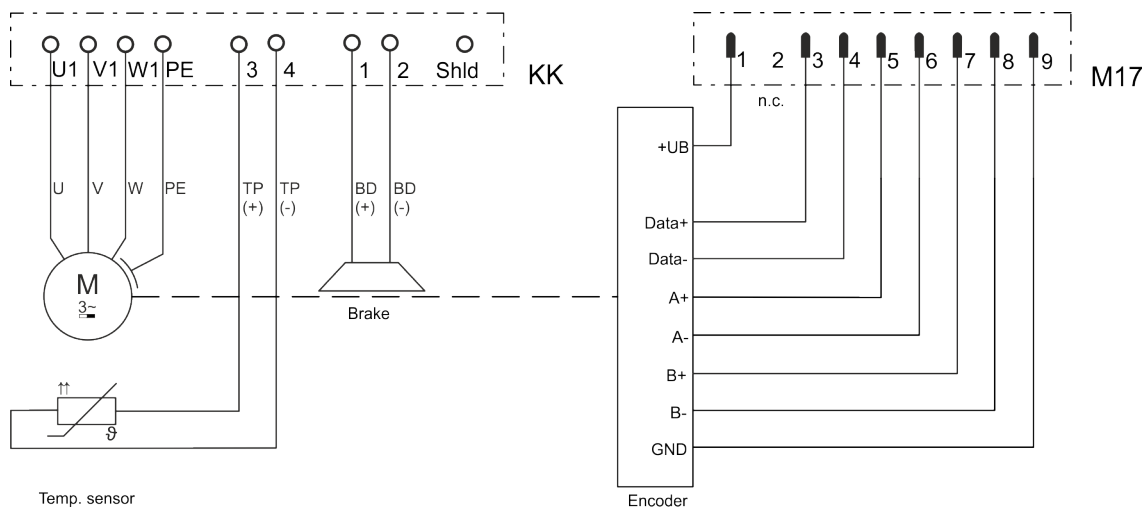

Fig. 361: Double cable connection terminal boxes, analog encoder A, brake optional

8.2.6 Double cable connection terminal box for MS2N with encoder (digital C, D, H) and optional brake

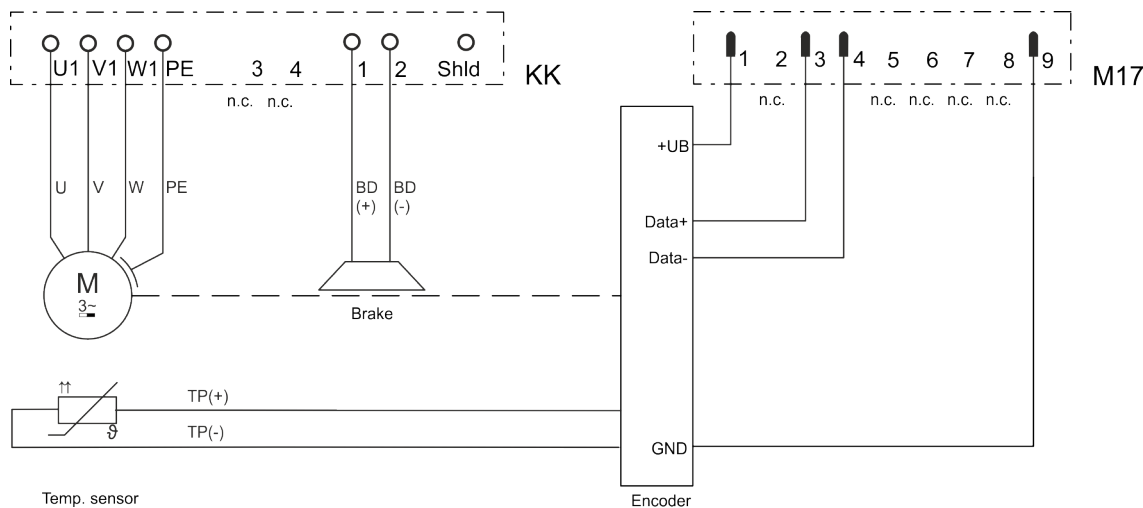
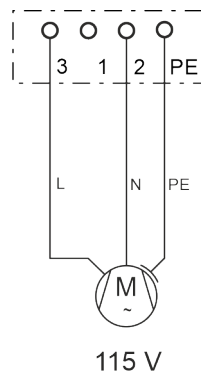

Fig. 362: Double cable connection terminal boxes, digital encoder C and D, brake optional

8.2.7 Fan 1-phase 115 V



Blower

Fig. 363: MS2N Fan connection 115 V

8.2.8 Fan 1-phase 230 V

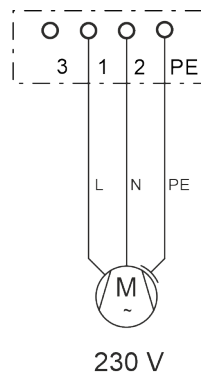

Blower

Fig. 364: MS2N Fan connection 230 V

8.2.9 Fan 3-phase 400 / 480 V

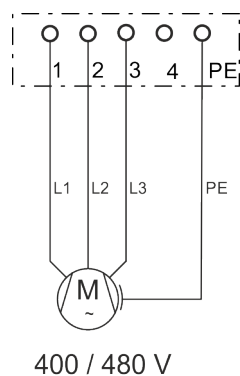

Blower

Fig. 365: MS2N Fan connection 400 / 480 V

8.3 M17 Encoder connector

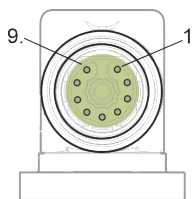

Fig. 366:
Connector view
of M17 encoder
connector

Table 21: Pin assignment of double cable connection encoder

Designation	Function				
	Encoder				
	A_	B_	C_	D_	H_
1	+UB		+UB		
2	n.c.		n.c.		
3	Data+		Data+		
4	Data-		Data-		
5	A+		n.c.		
6	A-		n.c.		
7	B+		n.c.		
8	B-		n.c.		
9	GND		GND		

Adjustment ranges

The output direction of the encoder connector M17 is adjustable. The device connectors can be manually rotated of a plug connector has been installed. Do not use any tools (e.g. pliers or screwdrivers) to turn the device connector to avoid damage.

Change the output direction a maximum of ten times and do not exceed the specified adjustment torques and the angle of rotation.

Adjustment ranges can be limited by adjacent plug connectors. In the following, the designs and possible adjustment ranges are represented.

Adjustment range/angle of rotation MS2N_ - _ - _ U

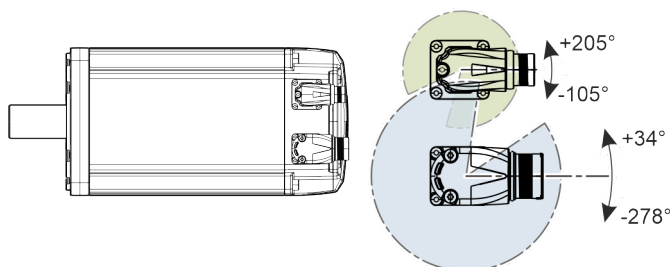

Fig. 367: Rotating area electrical connection "U"

Adjustment range/angle of rotation MS2N_ - _ - _ V

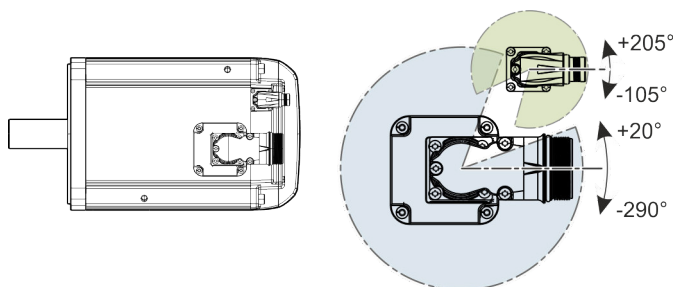

Fig. 368: Rotating area electrical connection "V"

Adjustment range/angle of rotation MS2N _ - _ - _ A/B

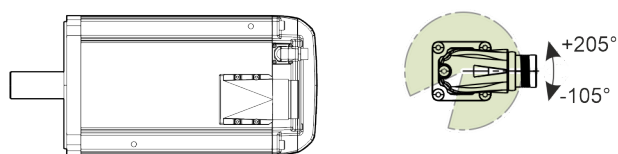

Fig. 369: Rotating area electrical connection “A/B”

Adjustment range/angle of rotation MS2N _ - _ - _ T

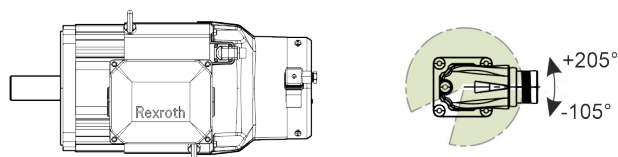

Fig. 370: Rotating area electrical connection “T”

Adjustment range/angle of rotation MS2N _ - _ - _ C

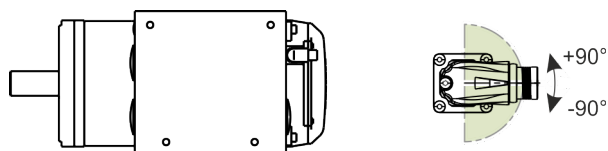

Fig. 371: Rotating area electrical connection “C”

Adjustment range/angle of rotation MS2N _ - _ - _ E

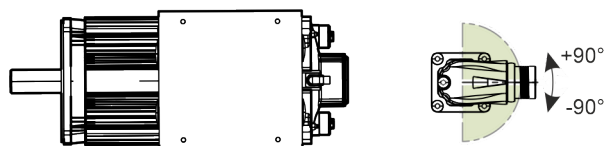

Fig. 372: Rotating area electrical connection “E”

Table 22: Adjustment torque plug connector encoder / M17

Connector/size	Adjustment torque
Encoder / M17	2 ... 6 Nm

8.4 M17 Double plug

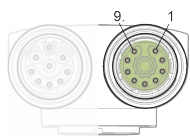

Fig. 373:
Connector view
double plug M17
encoder

Table 23: Pin assignment of double cable connection encoder

Designation	Function				
	Encoder				
	A_	B_	C_	D_	H_
1	+UB		+UB		
2	n.c.		n.c.		
3	Data+		Data+		
4	Data-		Data-		
5	A+		n.c.		
6	A-		n.c.		
7	B+		n.c.		
8	B-		n.c.		
9	GND		GND		

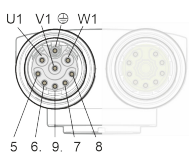

Fig. 374:
Connector view
double plug M17
power

Table 24: Pin assignment of double cable connection power

Designation	Function									
	Encoder									
	A_	B_	C_	D_	H_	A_	B_	C_	D_	H_
	with brake					without brake				
U1	A1		A1		A1	A1		A1		A1
V1	A2		A2		A2	A2		A2		A2
W1	A3		A3		A3	A3		A3		A3
⊕	PE		PE		PE	PE		PE		PE
5	TP(+)		n.c.		TP(+)	TP(+)		n.c.		n.c.
6	TP(-)		n.c.		TP(-)	TP(-)		n.c.		n.c.
7	BD(+)		BD(+)		n.c.	n.c.		n.c.		n.c.
8	BD(-)		BD(-)		n.c.	n.c.		n.c.		n.c.
9	n.c.		n.c.		n.c.	n.c.		n.c.		n.c.

Adjustment range

The output direction of the double plug M17 is adjustable. The device connectors can be manually rotated if a plug connector has been installed. Do not use any tools (e.g. pliers or screwdrivers) to turn the device connector to avoid damage.

Change the output direction a maximum of ten times and do not exceed the specified adjustment torques and the angle of rotation.

The theoretical setting range is shown below.

Adjustment range/angle of rotation MS2N_ - ____ - _D

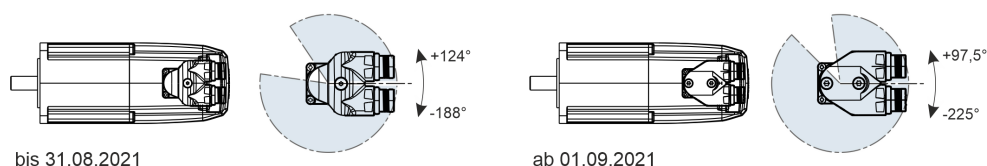

Fig. 375: Rotating area electrical connection "D"

Table 25: Adjustment torque double plug / M17

Connector/size	Adjustment torque
Double plug / M17	2 ... 10 Nm

8.5 M17 single cable connector, rotatable (SpeedTec)

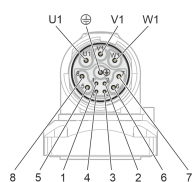

Fig. 376:
Connector view
of M17 single
cable connector

Table 26: Pin assignment of single cable connection

Designation	Function					
	Encoder					
	C_	D_	H_	C_	D_	H_
	with brake			without brake		
U1		A1		A1		
V1		A2		A2		
W1		A3		A3		
⊕		PE		PE		
1		+UB		+UB		
2		Data+		Data+		
3		GND		GND		
4		Data-		Data-		
5		Shld_Enc		Shld_Enc		
6		Shld_BD		Shld_BD		
7		BD(+)		n.c.		
8		BD(-)		n.c.		

Adjustment range

The output direction of the single cable connector M17 is adjustable. The device connectors can be manually rotated of a plug connector has been installed. Do not use any tools (e.g. pliers or screwdrivers) to turn the device connector to avoid damage.

Change the output direction a maximum of ten times and do not exceed the specified adjustment torques and the angle of rotation.

The theoretical setting range is shown below.

Adjustment range/angle of rotation MS2N__-___-__H

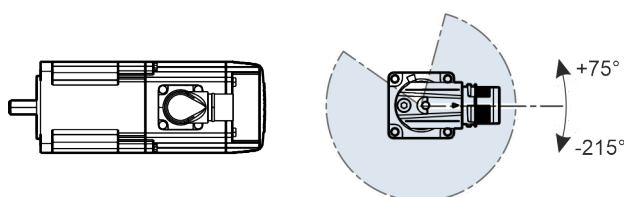

Fig. 377: Rotating area electrical connection "H"

Table 27: .Adjustment torque single cable connector / M17

Connector/size	Adjustment torque
Single cable connector / M17 (SpeedTec)	4 ... 9 Nm

8.6 M23 single cable connector, rotatable (SpeedCon)

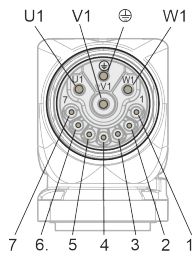

Fig. 378:
Connector view
of M23 single
cable connector

Table 28: Pin assignment of single cable connection

Designation	Function					
	Encoder					
	C_	D_	H_	C_	D_	H_
	with brake			without brake		
U1	A1			A1		
V1	A2			A2		
W1	A3			A3		
⊕	PE			PE		
1	+UB			+UB		
2	GND			GND		
3	Data+			Data+		
4	Data-			Data-		
5	Shld			Shld		
6	BD(+)			n.c.		
7	BD(-)			n.c.		

Adjustment range

The output direction of the single cable connector M23 is adjustable. The device connectors can be manually rotated of a plug connector has been installed. Do not use any tools (e.g. pliers or screwdrivers) to turn the device connector to avoid damage.

Change the output direction a maximum of ten times and do not exceed the specified adjustment torques and the angle of rotation.

The theoretical setting range is shown below.

Adjustment range/angle of rotation MS2N_ - _ - _S

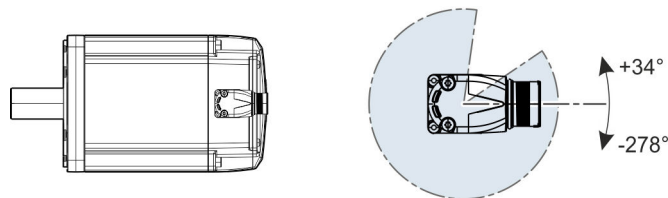

Fig. 379: Rotating area electrical connection "S"

Table 29: .Adjustment torque single cable connector / M23

Connector/size	Adjustment torque
Single cable connector / M23	4 ... 10 Nm

8.7 M23 cable connector, rotatable (SpeedCon)

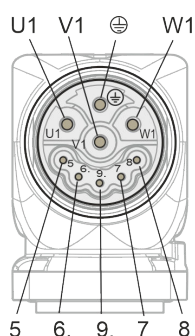

Fig. 380:
Connector view
of M23
performance
connector

Table 30: Pin assignment of double cable connection power

Designation	Function									
	Encoder									
	A_	B_	C_	D_	H_	A_	B_	C_	D_	H_
	with brake					without brake				
U1	A1			A1		A1			A1	
V1	A2			A2		A2			A2	
W1	A3			A3		A3			A3	
⊕	PE			PE		PE			PE	
5	TP(+)			n.c.		TP(+)			n.c.	
6	TP(-)			n.c.		TP(-)			n.c.	
7	BD(+)			BD(+)		n.c.			n.c.	
8	BD(-)			BD(-)		n.c.			n.c.	
9	n.c.			n.c.		n.c.			n.c.	

The output direction of the power connector and the encoder connector can be adjusted. The device connectors can be manually rotated of a plug connector has been installed. Do not use any tools (e.g. pliers or screwdrivers) to turn the device connector to avoid damage.

Change the output direction a maximum of ten times and do not exceed the specified adjustment torques and the angle of rotation.

Adjustment ranges can be limited by adjacent plug connectors. In the following, the designs and possible adjustment ranges are represented.

Adjustment range/angle of rotation MS2N_ - ____ - _U

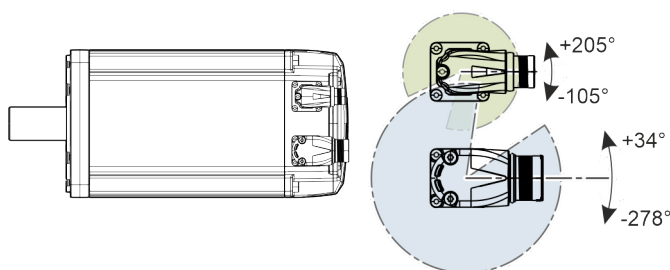

Fig. 381: : Rotating area electrical connection "U"

Table 31: .Adjustment torque plug connector power / M23

Connector/size	Adjustment torque
Power / M23	4 ... 10 Nm

8.8 M40 cable connector, rotatable (SpeedCon)

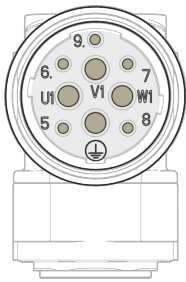

Fig. 382:
Connector view
of M40
performance
connector

Table 32: Pin assignment of double cable connection power

Designation	Function									
	Encoder									
	A_	B_	C_	D_	H_	A_	B_	C_	D_	H_
	with brake					without brake				
U1	A1			A1		A1			A1	
V1	A2			A2		A2			A2	
W1	A3			A3		A3			A3	
⊕	PE			PE		PE			PE	
5	TP(+)			n.c.		TP(+)			n.c.	
6	TP(-)			n.c.		TP(-)			n.c.	
7	BD(+)			BD(+)		n.c.			n.c.	
8	BD(-)			BD(-)		n.c.			n.c.	
9	n.c.			n.c.		n.c.			n.c.	

The output direction of the power connector and the encoder connector can be adjusted. The device connectors can be manually rotated of a plug connector has been installed. Do not use any tools (e.g. pliers or screwdrivers) to turn the device connector to avoid damage.

Change the output direction a maximum of ten times and do not exceed the specified adjustment torques and the angle of rotation.

Adjustment ranges can be limited by adjacent plug connectors. In the following, the designs and possible adjustment ranges are represented.

Adjustment range/angle of rotation MS2N_ - ___ - _V

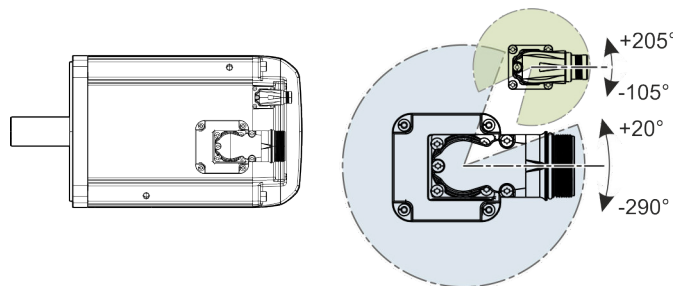

Fig. 383: : Rotating area electrical connection "V"

Table 33: Adjustment torque plug connector power / M40

Connector/size	Adjustment torque
Power / M40	12 ... 18 Nm

8.9 M58 cable connector, fixed (thread)

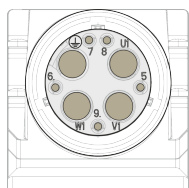

Fig. 384:
Connector view
of M58
performance
connector

Table 34: Pin assignment of double cable connection power

Designation	Function									
	Encoder									
	A_	B_	C_	D_	H_	A_	B_	C_	D_	H_
	with brake					without brake				
U1	A1			A1		A1			A1	
V1	A2			A2		A2			A2	
W1	A3			A3		A3			A3	
⊕	PE			PE		PE			PE	
5	TP(+)			n.c.		TP(+)			n.c.	
6	TP(-)			n.c.		TP(-)			n.c.	
7	BD(+)			BD(+)		n.c.			n.c.	
8	BD(-)			BD(-)		n.c.			n.c.	
9	n.c.			n.c.		n.c.			n.c.	

Adjustment range

The output direction of the power connector and the encoder connector is selectable when ordering.

8.10 Terminal box size "T"

The terminal boxes of the motors are optimized for the respective motor current. Upon delivery, the terminal box openings are closed with dummy plugs. Cable entries are not included in the scope of delivery. Ready-made connection cables are supplied with cable entries.

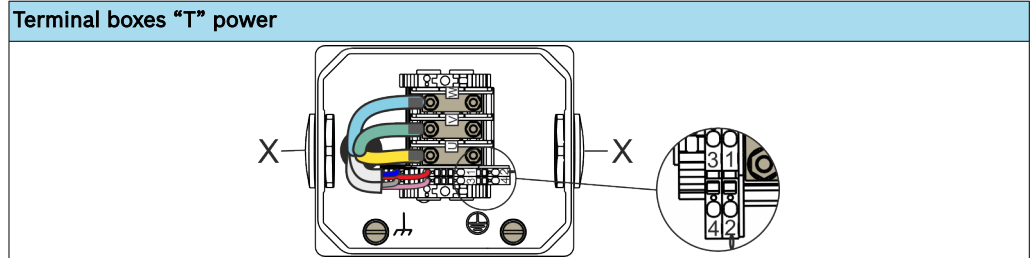

Pin assignment, terminal boxes "T", power			
MS2N	Encoder A_, B_	Encoder C_, D_, H_	Cable**)
U	A1	A1	1
V	A2	A2	2
W	A3	A3	3
1	BD(+) *)	BD(+) *)	7
2	BD(-) *)	BD(-) *)	8
3	TP1(+)	n.c.	5
4	TP2(-)	n.c.	6
⊕	PE	PE	GNYE
⌚	Shld	Shld	Shld

*) n.c. without brake
**) Bosch Rexroth types REL, RL2, RLB2



Remark

- Assign not used connection wires within the terminal box.
- In case of motors with encoder C_, and D_, the temperature signals are transmitted digitally via the encoder interface. In this case, the temperature wires of ready-made power cables do not have any function, but must be connected according to the pin assignment in the terminal boxes.

Technical data, connection points terminal boxes "T", power	
U, V, W	Bolts M5, M _A 2 ... 3 Nm Rated cross section 16 mm ² Rated current 65 A
1-4	Tension spring connection 0.5 ... 2.5 mm ² with wire end ferrule
⊕, ⌚	Screwed connection M8, M _A 3.8 Nm

The cable entries "X" are locked with a dummy plugs, at delivery. For bolted threads refer to the following table.

Cable entries "X", terminal boxes "T", power	
Motor	Size "X"
MS2N10-C0BHA-_T_-_-_-_-	2 x M32
MS2N10-C0BHB-_T_-_-_-_-	
MS2N10-C0BNA-_T_-_-_-_-	
MS2N10-C0BNB-_T_-_-_-_-	
MS2N10-C0BHL-_T_-_-_-_-	
MS2N10-C0BNL-_T_-_-_-_-	

Cable entries "X", terminal boxes "T", power	
Motor	Size "X"
MS2N10-D0BHA-__T_-____-	2 x M40
MS2N10-D0BHB-__T_-____-	
MS2N10-D0BNA-__T_-____-	
MS2N10-D0BNB-__T_-____-	
MS2N10-E0BHA-__T_-____-	
MS2N10-E0BHB-__T_-____-	
MS2N10-E0BNA-__T_-____-	
MS2N10-E0BNB-__T_-____-	
MS2N10-F0BDA-__T_-____-	
MS2N10-F0BDB-__T_-____-	
MS2N10-F0BHA-__T_-____-	
MS2N10-F0BHB-__T_-____-	
MS2N10-E1BNA-__T_-____-	
MS2N10-E1BNB-__T_-____-	
MS2N10-F1BHA-__T_-____-	
MS2N10-F1BHB-__T_-____-	
MS2N10-D0BHL-__T_-____-	
MS2N10-D0BNL-__T_-____-	
MS2N10-E0BHL-__T_-____-	

8.11 Terminal boxes size "C" (MS2N10)

The terminal boxes of the motors are optimized for the respective motor current. Upon delivery, the terminal box openings are closed with dummy plugs. Cable entries are not included in the scope of delivery. Ready-made connection cables are supplied with cable entries.

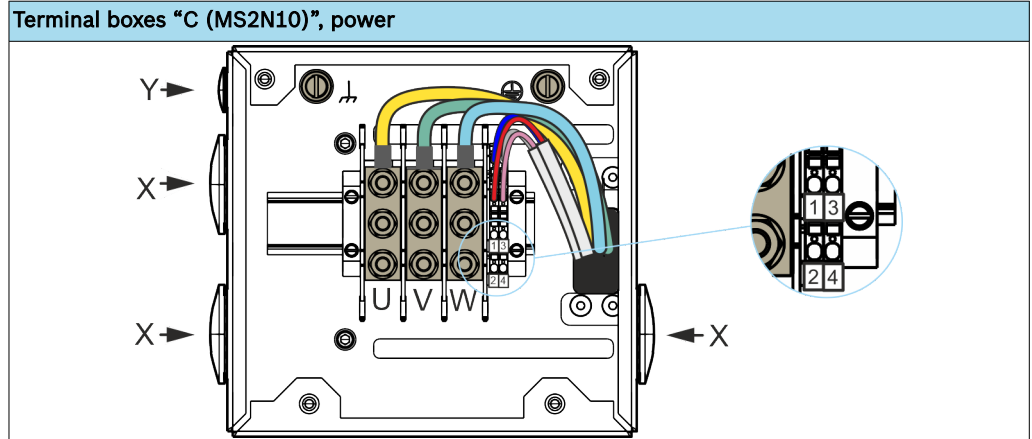

Pin assignment, terminal boxes "C (MS2N10)", power

MS2N	Encoder A_ B_	Encoder C_ D_ H_	Cable**)
U	A1	A1	1
V	A2	A2	2
W	A3	A3	3
1	BD(+) *)	BD(+) *)	7
2	BD(-) *)	BD(-) *)	8
3	TP1(+)	n.c.	5
4	TP2(-)	n.c.	6
⊕	PE	PE	GNYE
⏚	Shld	Shld	Shld

*) n.c. without brake
**) Bosch Rexroth types REL, RL2, RLB2



Remark

- Assign not used connection wires within the terminal box.
- In case of motors with encoder C_, D_ and H_, the temperature signals are transmitted digitally via the encoder interface. In this case, the temperature wires of ready-made power cables do not have any function, but must be connected according to the pin assignment in the terminal boxes.

Technica data, connection points terminal boxes "C (MS2N10)", power

U, V, W	Bolts M8, M _A 6 ... 12 Nm Rated cross section 50 mm ² Rated current 150 A
1-4	Tension spring connection 0.5 ... 2.5 mm ² with wire end ferrules
⊕, ⏚	Screwed connection M8, M _A 3.5 Nm

The cable entries "X" and "Y" are locked with dummy plugs, at delivery. For bolted threads refer to the following table.

Cable entries "X" and "Y", terminal boxes "C (MS2N10)", power

Motor	Size "X"	Size "Y"

Cable entries "X" and "Y", terminal boxes "C (MS2N10)", power		
MS2N10-E0BNL-__C__-__-__	3x M50	1x M20
MS2N10-F0BHL-__C__-__-__		
MS2N10-R0BQL-__C__-__-__		

8.12 Terminal boxes size "C" (MS2N13)

The terminal boxes of the motors are optimized for the respective motor current. Upon delivery, the terminal box openings are closed with dummy plugs. Cable entries are not included in the scope of delivery. Ready-made connection cables are supplied with cable entries.

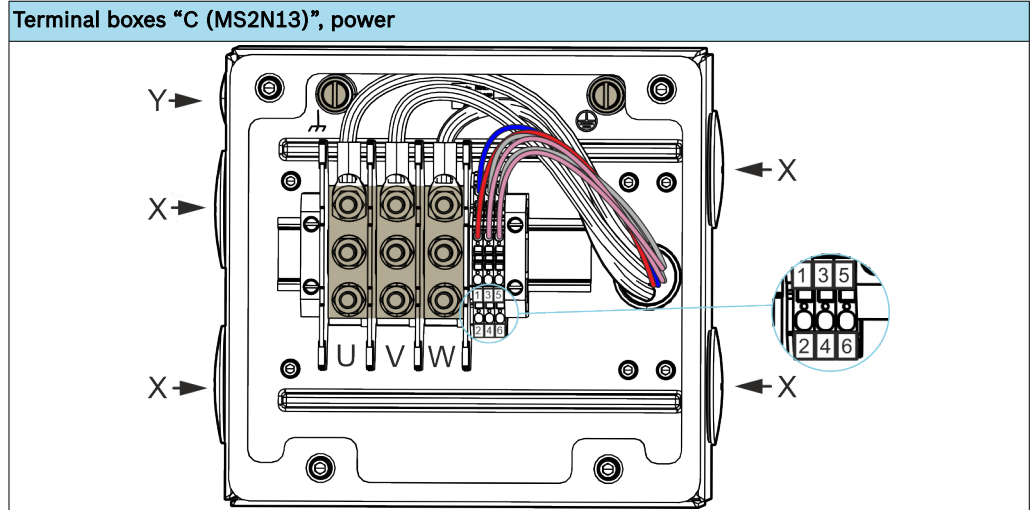

Pin assignment, terminal boxes "C (MS2N13)", power

MS2N	Encoder A_ B_	Encoder C_ D_ H_	Cable**)
U	A1	A1	1
V	A2	A2	2
W	A3	A3	3
1	BD(+) *)	BD(+) *)	7
2	BD(-) *)	BD(-) *)	8
3	TP1(+)	n.c.	5
4	TP2(-)	n.c.	6
⊕	PE	PE	GNYE
⏚	Shld	Shld	Shld

*) n.c. without brake
**) Bosch Rexroth types REL, RL2, RLB2



Remark

- Assign not used connection wires within the terminal box.
- In case of motors with encoder C_, D_ and H_, the temperature signals are transmitted digitally via the encoder interface. In this case, the temperature wires of ready-made power cables do not have any function, but must be connected according to the pin assignment in the terminal boxes.

Technical data, connection points terminal boxes "C (MS2N13)", power

U, V, W	Bolts M8, M _A 6 ... 12 Nm Rated cross section 50 mm ² Rated current 150 A
1-4	Tension spring connection 0.5 ... 2.5 mm ² with wire end ferrules
⊕, ⏚	Screwed connection M8, M _A 3.5 Nm

The cable entries "X" and "Y" are locked with dummy plugs, at delivery. For bolted threads refer to the following table.

Cable entries "X" and "Y", terminal boxes "C (MS2N13)", power		
Motor	Size "X"	Size "Y"
MS2N13-B1BHN-__C-__-__-__	4x M50	1x M20
MS2N13-B1BNN-__C-__-__-__		
MS2N13-C1BHN-__C-__-__-__		
MS2N13-C1BNN-__C-__-__-__		
MS2N13-B1BHC-__C-__-__-__		
MS2N13-B1BNC-__C-__-__-__		
MS2N13-C1BHC-__C-__-__-__		
MS2N13-C1BNC-__C-__-__-__		
MS2N13-B1BHL-__C-__-__-__		
MS2N13-B1BNL-__C-__-__-__		
MS2N13-C1BHL-__C-__-__-__		
MS2N13-C1BNL-__C-__-__-__		

8.13 Terminal box size "E"

The terminal boxes of the motors are optimized for the respective motor current. Upon delivery, the terminal box openings are closed with dummy plugs. Cable entries are not included in the scope of delivery. Ready-made connection cables are supplied with cable entries.

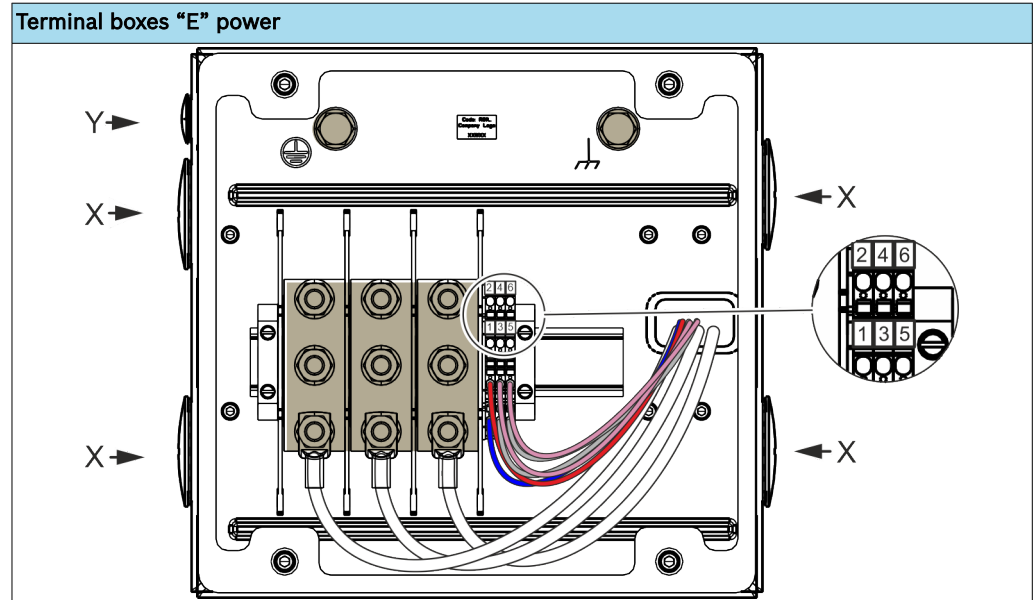

Pin assignment, terminal boxes "E", power

MS2N	Encoder A_ B_	Encoder C_ D_ H_	Cable**)
U	A1	A1	1
V	A2	A2	2
W	A3	A3	3
1	BD(+) *)	BD(+) *)	7
2	BD(-) *)	BD(-) *)	8
3	TP1(+)	n.c.	5
4	TP2(-)	n.c.	6
⊕	PE	PE	GNYE
⏏	Shld	Shld	Shld

*) n.c. without brake
**) Bosch Rexroth types REL, RL2, RLB2



Remark

- Assign not used connection wires within the terminal box.
- The terminal block can be moved on the top-hat rail in order to be able to wire cable outlet directions optimally. The terminal box is suited for double cabling

Technical data, connection points terminal boxes "E", power

U, V, W	Bolts M10, M _A 10 ... 20 Nm Rated cross section 50 6 ... 120 mm ² Rated current 269 A
1-4	Tension spring connection 0.5 ... 2.5 mm ² with wire end ferrules
⊕, ⏏	Screwed connection M10, M _A 10 Nm

The cable entries "X" and "Y" are locked with dummy plugs, at delivery. For bolted threads refer to the following table.

Cable entries "X" and "Y", terminal boxes "T", power		
Motor	Size "X"	Size "Y"
MS2N13-D1BHN-__E__-__-__	4x M50	1x M20
MS2N13-D1BNN-__E__-__-__		
MS2N13-E1BHN-__E__-__-__		
MS2N13-E1BNN-__E__-__-__		
MS2N13-D1BHC-__E__-__-__		
MS2N13-D1BNC-__E__-__-__		
MS2N13-E1BNC-__E__-__-__		
MS2N13-E1BHC-__E__-__-__		
MS2N13-D1BHL-__E__-__-__		
MS2N13-D1BNL-__E__-__-__		
MS2N13-E1BHL-__E__-__-__		
MS2N13-E1BNL-__E__-__-__		

Notes on cabling

The terminal block can be moved on the DIN rail. This may be necessary in order to be able to wire cable outlet directions optimally. The terminal box is suited for double cabling

8.14 Fan 1-phase 115 / 230 V

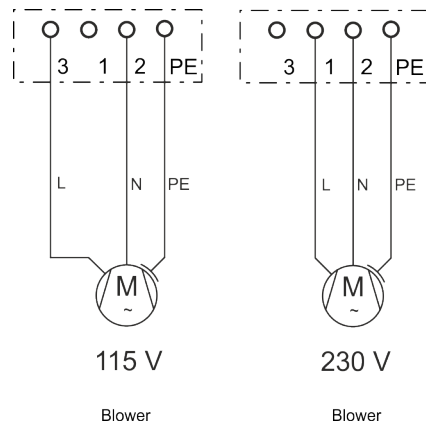

Fig. 385: MS2N Fan connection 115/ 230 V

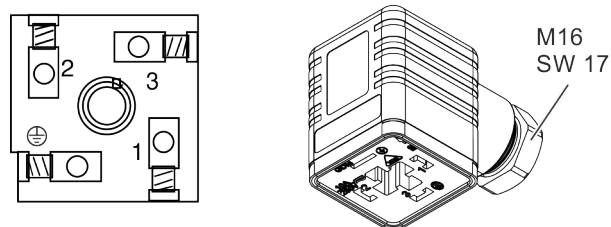

Fig. 386: RLSxxxx_Single components fan connector

Table 35: Connector fan unit for MS2N__-__A (U_N 230 V) / MS2N__-__B (U_N 115 V)

Assignment		Connection
1	L1 230 V	Screwed connection 0.5 ... 1.5 mm ²
2	N	
3	L1 115 V	
⊕	PE	



Remark

The plug insert can be mounted in any position into the connector housing. Therewith, the cable output direction can be done in steps of 90 degrees.

Protection by integrated thermal protection

MS2N Fan 115 / 230 V with integrated thermal protection do not need an external motor protective switch.

8.15 Fan 3-phase 400 / 480 V

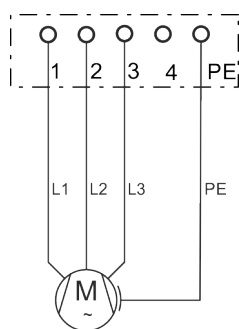

400 / 480 V

Blower

Fig. 387: MS2N Fan connection 400 / 480 V

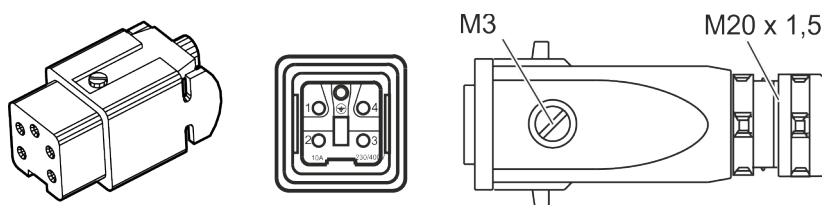

Fig. 388: RLS0782_Single components fan connector

Table 36: Connector fan unit for MS2N_ - _C (U_N400 / 480 V)

Assignment		Connection
1	L1	0.5 ... 2.5 mm ²
2	L2	22 ... 12 AWG
3	L3	Clamping screws M3 / tightening torque 0.5 ...
4	n. c.	0.7 Nm
⊕	PE	

Protection by motor protection switch

The fan units are connected via adjustable motor protection devices. The motor protection switch must be set to the rated current of the fan unit. When selecting the motor protection switches, make sure that the setting range matches the rated current of the fan unit.

8.16 Ground connection

For MS2N motors, an additional grounding connection is provided. Refer to the following data to provide an additional grounding connection.

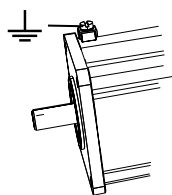

Ground connection	Screw M5
Clamping range	4 mm ² (fine-wired); 6 mm ² (single stranded)

Ground connection	Screw M5
Tightening torque	maximum 2 Nm
Mounting notes	The screw terminal block with clamping bracket has to be assigned in a correct way according to EN 60999-1: 2000.

8.17 Shielding concept

Converter-fed drives can generate high-frequency discharge currents in motor cables and motors. By using shielded cables and a large-area, low-impedance connection of the shield connections at motor and controller, impedances can be minimized and the discharge currents can be lead from the motor to the controller. Ready-made cables of Bosch Rexroth are designed and tested according to the requirements of installed motor components.

For more information about Electromagnetic compatibility (EMC), refer to the project planning manual of the respective drive system.

8.18 Ready-made connecting cable

Preassembled power cables, encoder cables and hybrid cables can be provided for the motors. Motors with double cable technology are connected with a power and an encoder cable each. Motors with single cable technology are connected using a hybrid cable. The hybrid cable combines the functionality of power and encoder cable.

Die maximum cable length is 75 meters. The maximum cable length can be limited in case of certain motor control unit combinations. Please refer to the documentation about the control unit.

Please contact your sales partner in case of questions about available connection cables.

9 Connection water cooling

Any installation material, like tubes or mounting clamps are not in the scope of delivery. Choose a supply hose with correct inner diameter.

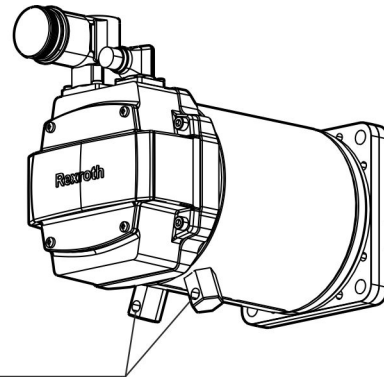

ISO 228-G 1/8

Fig. 389: Coolant connection MS2N07

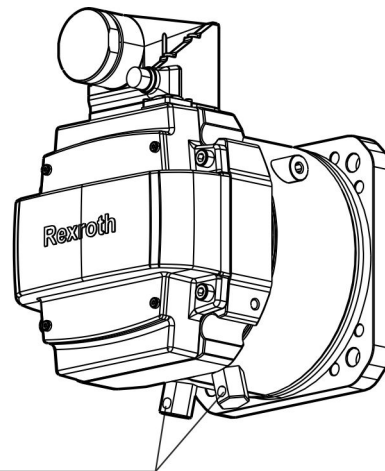

ISO 228-G 1/8

Fig. 390: Coolant connection MS2N10-__L__B__

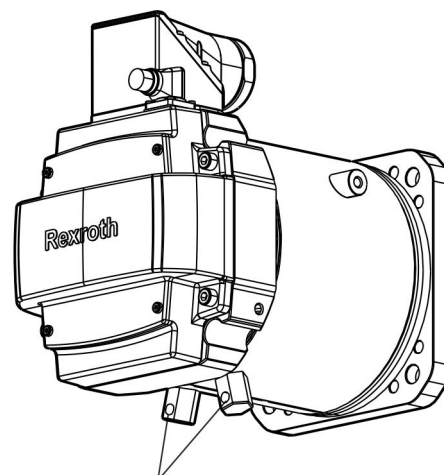

ISO 228-G 1/8

Fig. 391: Coolant connection MS2N10-__L__A__

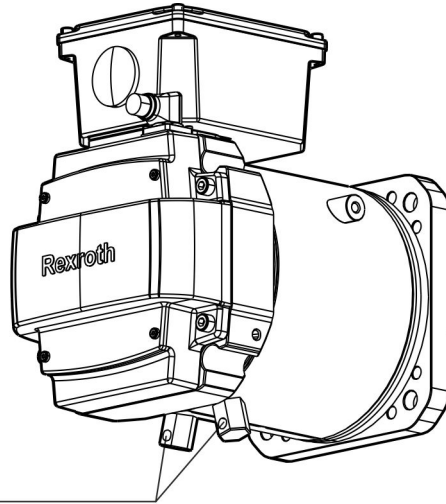

ISO 228-G 1/8

Fig. 392: Coolant connection MS2N10-__L__T__

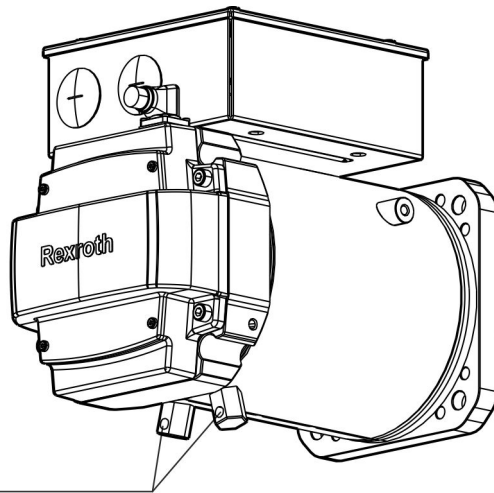

ISO 228-G 1/8

Fig. 393: Coolant connection MS2N10-__L__C__

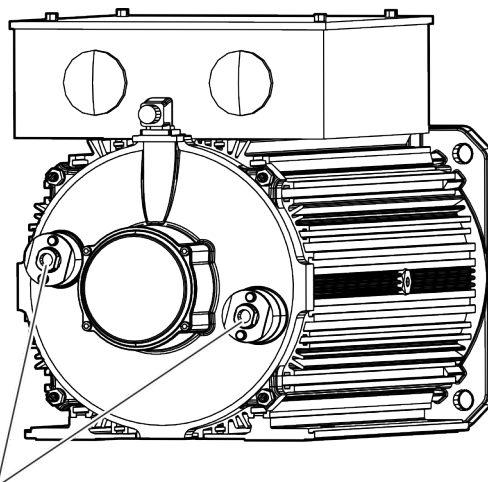

ISO 228-G 1/4

Fig. 394: Coolant connection MS2N13-__L__E__



Remark

The allocation of intake (IN) and outtake (OUT) can be arbitrarily done. It does not influence the power data of the motor in any way.

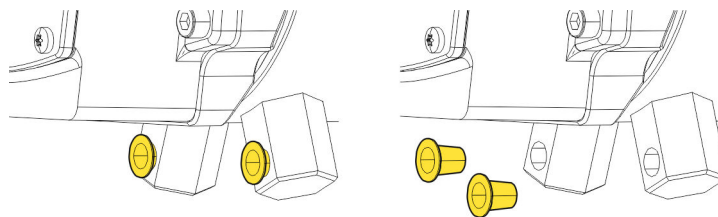

Fig. 395: Protective plug MS2N07, MS2N10 water cooling

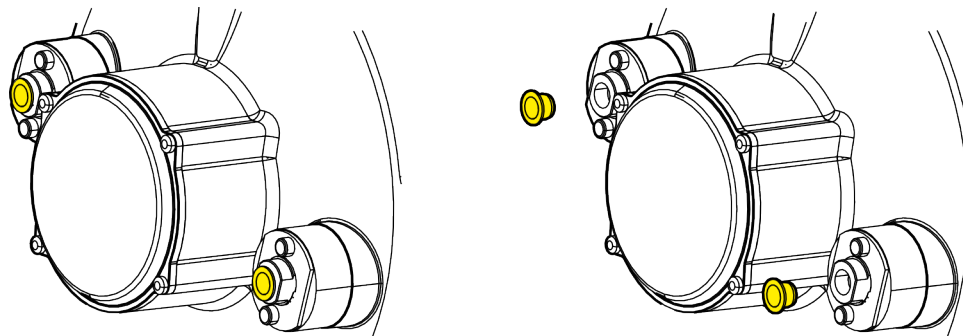

Fig. 396: Protective plug MS2N13 water cooling

The connecting threads on the motor are covered with factory-attached protective caps. These protective caps may only be removed immediately before screwing in the coolant ducts to prevent dirt from entering into the cooling system.

Table 37: Coolant connection thread, allowed tightening torques and screw-in depths

Motor	Connection	Screw-in depth [mm]	Tightening torque [Nm]
MS2N07	Pipe thread ISO228-G 1/8	10	14 ... 15
MS2N10	Pipe thread ISO228-G 1/8	10	14 ... 15
MS2N13	Pipe thread ISO228-G 1/4	14	18 ... 20

NOTICE

The coolant port threads on the motors may be damaged by incorrect tightening torques!

The allowed motor connection tightening torque may not be exceeded! If the tightening torque or screw-in depth is exceeded, the motor may be damaged irreversibly.

The coolant connections are designed for screw connections with axial sealing.

Bosch Rexroth therefore recommends to use screw connections which contain an O-ring for sealing the screw connection in axial direction.

Seals consisting of hemp, teflon tape or cone-shaped screw connections are not considered to be suitable, as these seals may stress the connection thread at the motor and damage it permanently.

**Remark**

The machine manufacturer is responsible for ensuring that the coolant connection is tight and for verifying and accepting the tightness after the motor has been installed.

Additionally, record regular monitoring of the proper state of the coolant connection in the maintenance plan of the machine.

10 Sealing air connection

The sealing air connection is rotatable. The compressed air hose 4 × 0.75 is not included in the scope of delivery.

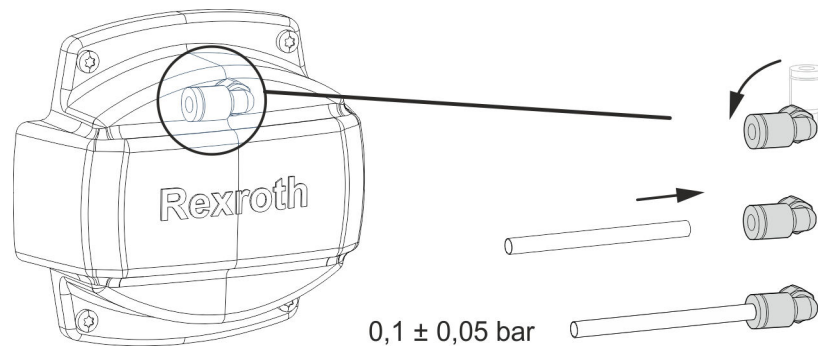

Fig. 397: Connection compressed air hose for using sealing air.

NOTICE

Damage due to permanent existing liquid on the shaft sealing ring!

The use of sealing air does **not** prevent the penetration of continuously existing liquid on the shaft sealing ring (e.g. for open gearboxes). Due to capillary action, gearbox oil can penetrate into the motor and damage it, despite using sealing air.

NOTICE

Damage due to ingress of dirt!

The compressed air gland is not closed upon delivery. Always operate motors with compressed air connection with connected compressed air supply.

11 Ambient conditions

11.1 Ambient conditions during operation

Climatic conditions are defined in classes according to EN IEC 60721. The classes are differentiated in the areas storage, transport and operation. They are based on long-term experiences and take all influencing variables into account, e.g., air temperature and air humidity.

A permanent use of the motors is possible when the specified class 3K22 according to EN IEC 60721-3-3:2019 is observed. Deviations and enhancements according to the following table must be observed.

Table 38: Ambient conditions

Operation	
Installation altitude	0 ... 1,000 m above MSL
Ambient temperature	0 ... +40 °C
Relative humidity	5 ... 95 %
Absolute humidity	1 ... 29 g/m ³

11.1.1 Vibration load during operation

Vibrations are sine-wave oscillations in stationary use, which vary in their effect on the resistance of the motors depending on their intensity.

The specified limit values are valid for frequencies of 10-2000 Hz during stimulation on the motor flange. Limitations can be necessary for occurring resonances depending on the application and installation situation.

The following limit values apply according to EN 60068-2-6 for MS2N motors:

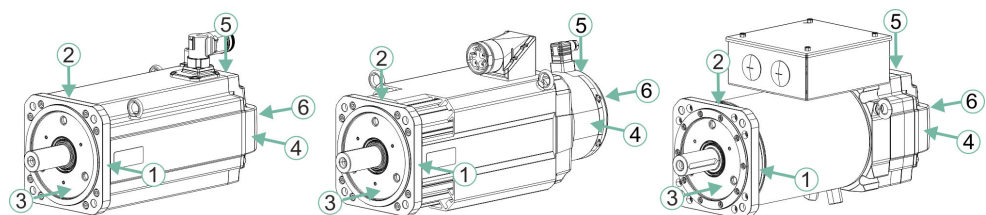

Fig. 398: Vibration load on measuring points

Table 39: Permissible vibration load for MS2N motors

Direction	Measuring point	Limit value (10-2000 Hz)		
		Motors Self-cooling	Motors Forced ventilation	Motors Water cooling
radial	1, 2 (radial motor flange)	30 m/s ²	10 m/s ²	10 m/s ²
	4, 5 (radial bearing shield / fan)	50 m/s ²	25 m/s ²	25 m/s ²
axial	3 (axial motor flange)	10 m/s ²	10 m/s ²	10 m/s ²
	6 (axial bearing shield / fan)	25 m/s ²	25 m/s ²	25 m/s ²

Check the vibration load on the fan housing in case of forced ventilation. The specified values must not be exceeded.

11.2 Derating in case of deviating ambient conditions

Reduce high performance data:

1. Reduce the standstill torque $M_{0\ 60K}$ or $M_{0\ 100K}$ specified in the data sheet, with the following factors.

We have:

$$M_{0\ red} = M_{0\ 60K} \times f_{TH\ 60K}$$

$$M_{0\ red} = M_{0\ 100K} \times f_{TH\ 100K}$$

$$M_{0\ red} = M_{0\ 100K} \times f_{TH\ W}$$

2. Pan the S1-characteristic curve M_{S1} parallel to the speed axis to the junction of the S1-characteristic curve and to the calculated point $M_{0\ red}$ on the torque axis.

➔ The determined characteristic curve $M_{S1\ red}$ shows approximately the S1-characteristic curve with appropriate derating.

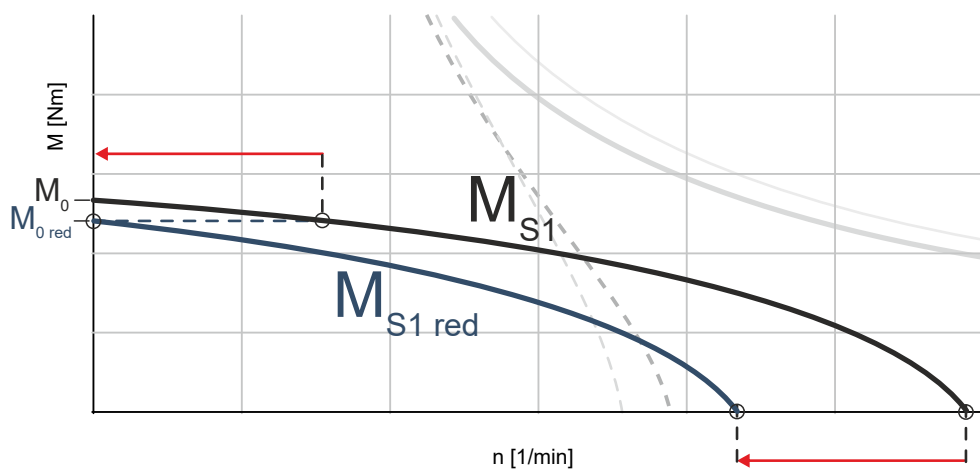

Fig. 399: Determine S1-characteristic curve $M_{S1\ red}$ with derating factor f_{TH}

Table 40: Derating factors for self-cooling 60K

Height [m]	40 °C	45 °C	50°C	55 °C	60 °C
1,000	1.00	0.94	0.88	0.83	0.78
1,500	0.97	0.91	0.85	0.81	0.76
2,000	0.94	0.88	0.83	0.78	0.73
2,500	0.90	0.85	0.79	0.75	0.70
3,000	0.86	0.81	0.76	0.71	0.67

Table 41: Derating factors for self-cooling 100K and forced ventilation

Height [m]	40 °C	45 °C	50°C	55 °C	60 °C
1,000	1.00	0.96	0.92	0.88	0.85
1,500	0.97	0.93	0.89	0.85	0.82
2,000	0.94	0.90	0.86	0.83	0.80
2,500	0.90	0.86	0.83	0.79	0.77
3,000	0.86	0.83	0.79	0.76	0.73

Table 42: Derating factors for self-cooling 100K and forced ventilation

Height [m]	40 °C	45 °C	50°C	55 °C	60 °C
1,000	1.00	0.96	0.92	0.88	0.85
1,500	0.97	0.93	0.89	0.85	0.82
2,000	0.94	0.90	0.86	0.83	0.80
2,500	0.90	0.86	0.83	0.79	0.77

Height [m]	40 °C	45 °C	50°C	55 °C	60 °C
3,000	0.86	0.83	0.79	0.76	0.73

To avoid condensation of the motors, the coolant supply temperature must be above the dew point temperature [Fig. 3](#).

11.3 Operation on foreign converters

Principally, operating MS2N motors on foreign converters is possible. In the following, the designs and possible adjustment ranges are represented.

⚠ WARNING

Danger of explosion or material damage due to overload!

Observe the following requirements for safe motor operation on foreign converters. Connection of all necessary sensors and additional devices for a safe operation and their evaluation lies in the sole responsibility of the plant manufacturer or operator.

Requirements on the power output stage

- Converter with pulse width modulation
- Pulse frequency 4 kHz ...16 kHz

Voltage load of the motor

During converter operation, the motor underlies a higher voltage load (insulation system, bearing) than on a sinusoidal source voltage only.

Standard values for peak voltage and rate of rise of voltage:

- Peak voltage U_{pk} on motor clamps ≤ 1.56 kV
- Rate of rise of voltage $du/dt \leq 5$ kV/ μ s

Maximum allowed limit load:

In the case of critical rate of rise of off-state voltage $du/dt \geq 5$ kV/ μ s, the limit values (peak voltage, voltage rise time) according to limit curves A according to **DIN VDE 0530-25 (VDE 0530-25):2009-08 (Figure 14 Limit curve A)** must be kept. Therefore, observe the limit values for voltage rise time and critical rate of rise of off-state voltage.

Limit values for voltage rise time and critical rate of rise of off-state voltage:

- Voltage rise time > 0.17 μ s
- Rate of rise of off-state voltage $du/dt < 8$ kV/ μ s

Monitoring functions

- Speed monitoring of maximum permissible speed
- The motor load must not exceed the allowed continuous operation characteristic curve. The converter setting data for controlling and monitoring must comply with the type code data.
- Temperature control to protect from thermal overload
 - The temperature sensor of the motor winding must be connected and evaluated on the converter (ensure monitoring function, observe polarity of temperature sensor, limit switch-off temperature according to [Chapter 4.5 Thermal motor protection on page 20](#)).
 - Temperature model or I^2t -monitoring within converter. Due to the coupling time of the temperature sensor, an additional suitable temperature model or an I^2t -monitoring must be used.

Requirements for motor operation with holding brake

- Ensure the brake functionality during normal operation due to voltage control, current monitoring, cyclic control of the brake holding torque, for example.
- Provide an external or an integrated protective circuit within the foreign converter to switch the holding brake (inductive load).
- Never use the holding brake of the motor as an operating brake.
- Idle time after an emergency stop before restarting ≥ 3 minutes.

11.4 Transport

The motors must be transported in their original package taking classes 2K11, 2B1, 2C1, 2S5, 2M4 specified acc. to DIN EN 60721-3-2 into account.

Deviations and enhancements according to the following table must be observed.

Table 43: Deviations and enhancements of classification (DIN EN IEC 60721-3-2)

Transport	
Ambient temperature	-25 ... +70 °C
Relative humidity	5 ... 75 %
Shock load	→ Chapter 11.6 Shock load during transport und storage on page 449



Remark

Before transport, discharge the liquid coolant from liquid-cooled motors to avoid frost damage.

Instructions on transport by air

If motor components with permanent magnets are shipped by air, the DGR (Dangerous Goods Regulations) of the IATA (International Air Transport Association) for hazardous materials of class 9 which also include magnetized substances and objects has to be complied with. This involves, for example:

- Secondary parts of synchronous linear motors
- Rotors of synchronous kit motors
- Rotors of synchronous housing motors (if these are dispatched as motor component, i.e. separate from the stator or motor housing, in service cases)

For details on the maximum allowed magnetic field strengths as well as information on measurement methods for these magnetic field strengths, please refer to the current IATA DGR (see chapter 3.9.2.2).

11.4.1 Instructions on machine transport

NOTICE	<p>Never touch the connection points of electrostatic sensitive devices!</p> <ul style="list-style-type: none"> - Mounted components (e.g. temperature sensors, encoder) can contain parts susceptible to electrical discharge (ESD). Observe the ESD safety measures.
▲ WARNING	<p>Risk of injury and material damage due to improper handling during transport!</p> <ul style="list-style-type: none"> - Only use hoisting gear suited for the weight of the motors. Use lifting sling belts or lifting eye bolts. Secure the lifting eye bolts before use. - Never walk under hanging loads. - Do not lift the motor at the shaft or on the optional fan housing. - Use suitable protective equipment and protective clothing during transport, and wear safety shoes.

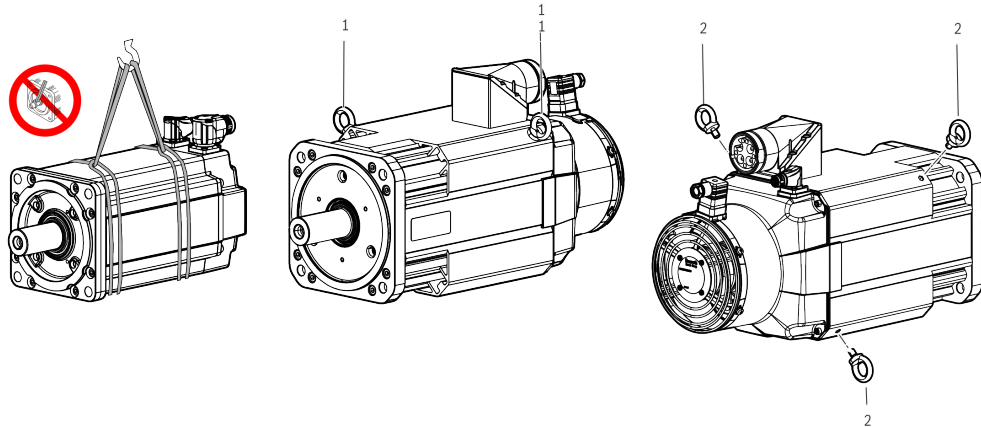

Fig. 400: Lifting and transporting motors

1 Eye bolts (check firm seating before use)

2 Eye bolts alternative position (check firm seat before use)

- Before transporting the motor, determine the weight of the motor. For more details about motor weight, please refer to the type plate or the project planning manual (Technical data).
- Adjust the carrying capacity of the lifting device to the motor weight.
- If provided by the manufacturer, all lifting eye bolts must be used and tightened before use.
- Avoid increased transport vibrations.
- Remove any existing transport locks prior to commissioning and keep them.

11.5 Storage

Store the motors in their original packaging in a dry, dust-free, vibration-free and light-protected place without direct solar radiation. Please observe classes 1K21, 1B1, 1C1, 1S10, 1M11 specified for storage acc. to DIN EN 60721-3-1.

Deviations and enhancements according to the following table must be observed.

Table 44: Deviations and enhancements of classification (DIN EN IEC 60721-3-1)

Bearing	
Ambient temperature	-25 ... +55 °C
Relative air humidity	5 ... 75 %
Absolute air humidity	1 ... 29 g/m ³
Direct solar radiation	Not permitted
Shock load	→ Chapter 11.6 Shock load during transport und storage on page 449

NOTICE

Damage due to moisture and humidity!

- Protect the products from dampness and corrosion.
- Store them only in rainproof and dry rooms.

Additional measures have to taken upon commissioning to ensure smooth functioning – irrespective of the storage time which may be longer than the warranty period of our products. Warranty extension is not a consequence.

Table 45: Measures before commissioning motors that have been stored over a prolonged period of time

Storage time / months			Measures for commissioning
> 1	> 12	> 60	
●	●	●	Visual inspection of all parts to be damage-free
●	●	●	Resurface the holding brake
	●	●	Check the electric contacts to verify that they are free from corrosion
	●	●	Let the motor run in without load for one hour at 800 ... 1000 rpm
	●	●	Measure insulation resistance. Dry the winding at a value of < 1kOhm per volt rated voltage.
		●	Replace bearings
		●	Replace encoder

11.6 Shock load during transport und storage

Function-impairing effects are avoided as long as the specified limits are complied with.

Table 46: Permissible shock load for MS2N motors

Frame size	Maximum allowed shock load (11 ms)	
	Axial	radial
MS2N03, -04, -05	100 m/s ²	1000 m/s ²
MS2N06		500 m/s ²
MS2N07		300 m/s ²
MS2N10, -13		200 m/s ²

The specified limit values do not apply to half-sine-shaped single shock load acc. to EN 60068-2-27.



Remark

The specifications do **not apply to motor operation**. Applications with continuous shock load make a case-by-case review necessary.

12 Service repair, maintenance and spare parts

Wearing parts are reliably and professionally repaired and replaced by the Rexroth Service in shopfloor-oriented quality.

MS2N-Motoren may only be repaired in the manufacturer's works or in a workshop authorized by Rexroth. The following repairs, for example, can be carried out in authorized workshops:

- Replace motor encoder
- Replace shaft sealing ring
- ...

The service lives of motor components, such as seals and bearings, may vary depending on the operating conditions, such as operation mode, speed, vibration and shock load, and frequent reverse mode. We recommend to change the bearing after 30,000 operating hours. Shorter replacement intervals may be necessary; cf. checks during operation. We recommend regular visual inspections on shaft sealing rings. Depending on operating conditions, signs of wear may appear after 5,000 operating hours. If necessary, replace the shaft sealing rings.

The Bosch Rexroth service helpdesk at our headquarters in Lohr, Germany and our worldwide service provide You can contact us **24/7**.

Telephone:	+49 (0) 9352 40 50 60
Fax:	+49 (0) 9352 18 49 41
Email	service.svc@boschrexroth.de
Internet:	↪ https://www.boschrexroth.com

Preparing information

For quick and efficient help, please have the following information ready:

- Detailed description of the fault and the circumstances
- Information on the rating plate of the products in question, particularly type codes and serial numbers
- Your contact data (phone number, fax number, email address)

13 Environmental protection and disposal

Disposal of the motor components can be done according to the applicable legal process in normal recycling process.

Recycling

Most of the products can be recycled due to their high content of metal. In order to recycle the metal in the best possible way, the products must be disassembled into individual assemblies. Metals contained in electric and electronic assemblies can also be recycled by means of special separation processes.

Basic components

Basically, our motors consist of the following components:

- Steel, stainless steel, aluminum, copper, brass
- Plastic parts, insulation and composite material
- Electronic components
- Permanent magnets

Plastic parts of the products may contain flame retardants. These plastic parts are labeled according to EN ISO 1043-1:2011 + A1:2016. They have to be recycled separately or disposed of according to the applicable legal provisions.

Magnets

▲ WARNING

Danger due to permanent magnets!

- Health hazard for persons with heart pacemakers, metallic implants and hearing aids in direct environment of permanent magnets.
- Crushing hazard of fingers and hand due to heavy attractive forces of the magnets.
- Risk of destruction of sensitive parts like watches, credit cards, ...



Remark

The permanent magnets of the rotor or secondary part must be demagnetized before disposal to avoid injuries or damage.

The demagnetization is reached via special thermal treatment. The handling duration is influenced by the rotor frame size. The rotor or the secondary part has to remain in the oven for a minimum of 30 minutes, starting at the time, the magnetic surface has reached 300 °C. If the magnets are surrounded by a bandage or a cover plate, it is recommended to remove it before heating in the oven to expose the magnets.

If demagnetization is successful, the magnets can be separated from the rotor or secondary part after cooling without applying force.

Packaging

Our packaging materials do not contain any problematic materials and can therefore be easily disposed. Packaging materials are: wood, cardboard and polystyrene.

Batteries and accumulators



The symbol indicating "separate collection" for all batteries and accumulators is the crossed-out wheeled bin. End users in the EU are legally bound to return used batteries and accumulators. Outside the scope of the EU Directive 2006/66/EC, the applicable regulations must be followed. Batteries and accumulators can contain hazardous substances which can harm the environment

or people's health when improperly stored or disposed of. The batteries or accumulators must be returned to the country-specific collection systems for proper disposal.

Disposal by the manufacturer

Our products can be returned to us for disposal. However, this requires that the products are free from oil, grease or other dirt. The motor components must be returned in a suitable packaging (origin package if possible). In the case of a transport by air freight, please observe the dangerous goods regulations (IATA) for the secondary part.

Send the products to the following address, carriage free:

Bosch Rexroth AG
Bgm.-Dr.-Nebel-Str. 2
97816 Lohr a.Main, Germany

14 Appendix

14.1 CE conformity



Declarations of conformity confirming the design and compliance with the valid EN standards and directives are available for MS2N motors. If required, the declarations of conformity can be requested from the responsible sales office. The CE mark is attached to the type label of the motors.

14.2 UL / CSA



The UL/CSA conformity of MS2N motors can be found on the type plate of the motors.

The MS2N motor listing with the UL file number E335445 can be found under www.ul.com

14.3 China RoHS 2



The China RoHS 2 conformity can be found on the type plate of the motors. Information about listing: <https://www.boschrexroth.com.cn/zh/cn/certificates/china-rohs2/>

14.4 China Energy Label (CEL)



Fig. 401: China Energy Label, Example MS2N

The **China Energy Label (CEL)** contains details about energy efficiency class and about energy use. Affected permanent magnet synchronous motors exported to China must be classified according to GB 30253-2013. Registered Bosch Rexroth motors are provided with the CEL marking and can be verified via the QR code on the product-specific web pages (CEL Registered products).

Registered Bosch Rexroth products (Chinese website)

➔ [MS2N Self-cooling - Grade 2](#)

➔ [MS2N Forced ventilation - Grade 2](#)

Affected products may only be market in China after a CEL classification of the product has been passed. **In case of not listed motor types, please contact Bosch Rexroth.**

Permanent magnet synchronous motors affected by CEL

- PM synchronous motors up to 1,000V
- Operation with (frequency-) converter
- Power range: 0.55 kW – 90 kW
- Speed range: 500 U/min – 3000 U/min

Permanent magnet synchronous (exceptions) not effected by CEL

- Motors with brakes
- Water-cooled motors
- Motors with integrated gearbox
- Motors outside of power and speed range

15 Index

- A**
- Accumulators. 453
 - Air-pressure connector kit. 441
 - Alignment. 35
 - Ambient conditions. 443
 - Ambient temperature. 443
 - Attachments. 29
- B**
- Balancing. 28, 29
 - Batteries. 453
 - Bearing. 37
 - Axial force. 38
 - Bearing service life. 37
 - Radial force. 38
 - Bevel gear pinion. 30
- C**
- Characteristic curve. 54, 57
 - Characteristic curves. 51
 - Coating. 39
 - Concentricity. 35, 36
 - connecting cable. 435
 - Connection electrically. 434
 - Connection water cooling. 437
 - Connector
 - M17 Encoder. 418
 - Continuous operation S1. 52
 - Coolant connection. 437
 - Coolants
 - Corrosion protection. 23
 - Cooling system. 22
 - Couplings. 29
 - CSA. 455
- D**
- DC bus voltage. 54
 - Degree of protection. 27
 - Disposal. 453
- E**
- Encoder. 26
 - ACURO®link. 26
 - Hiperface®. 26
 - Extension elements. 28
- F**
- Field weakening. 52
 - Flange
 - Alignment. 36
 - Concentricity. 35, 36
 - Flange exactness. 35
 - Forced ventilation. 21, 231, 342, 343, 405, 406
 - Frame size. 38
- G**
- Gearbox. 57
 - Gearbox mounting. 29
 - Ground connection. 40, 434
- H**
- Half key balancing. 29
 - Helical teeth. 30
 - Holding brake. 30
 - Commissioning. 35
- I**
- IM-Code EN 60034-7. 38
 - IndraSize. 58
 - Installation type. 38
 - Intended use. 11
 - IP Degree of protection. 27
 - IP-Code EN 60034-5. 27
- M**
- Materials contained. 453
 - Minimum distance. 21
 - Motor cooling
 - Coolant temperature. 25
 - Coolants. 23
 - Forced ventilation IC416. 21
 - Self-cooling IC410. 21
 - Water cooling IC3W7. 22
 - Motor encoder (see encoder). 26
- O**
- Operating area. 51
 - Operation on foreign converters. 446
 - Output shaft. 28
 - Overdetermined bearing. 29
- P**
- Packaging. 453
 - Periodic intermitted operation S3. 52
 - Plug connector
 - M17 Encoder. 416
- R**
- Rated data. 55
 - Ready-made connecting cable. 435
 - Returning products. 454
 - RoHS
 - China RoHS 2. 455
- S**
- Self-cooling. 21, 66, 67, 84, 102, 124, 230, 340, 404
 - Shaft
 - smooth. 28
 - with key way. 28
 - Shielding concept. 435
 - Specification
 - MS2N03. 66, 67
 - MS2N04. 84
 - MS2N05. 102
 - MS2N06. 124
 - MS2N07. 230, 231, 232
 - MS2N10. 340

MS2N10 Forced ventilation specification with terminal boxes.	342
MS2N10 Forced ventilation with connector.	343
MS2N10 Water cooling with connectors A, B	345
MS2N10 Water cooling with terminal box T.	345
MS2N13 Forced ventilation specification with terminal boxes C, E.	405
MS2N13 Self-cooling with terminal boxes C, E.	404
MS2N13 Water cooling with terminal boxes C, E.	406
Specifications	
MS2N10 Water cooling with terminal boxes C	344
Storage.	448
T	
Technical data.	59
Temperature.	56
Temperature sensor.	20
terminal box	
Size "E"	431
Terminal box	
Size "T"	425
Terminal boxes	
Size "C"	427, 429
Tolerance.	56
Transport.	447
Type code	
MS2N03.	41
MS2N04.	42
MS2N05.	43
MS2N06.	44
MS2N07.	45
MS2N10.	47
MS2N13.	49
Type plate.	15
U	
UL.	455
Unintended use.	11
V	
Vibration.	443
Vibration behavior.	36
W	
Water cooling.	232, 344, 345, 437

Bosch Rexroth AG
Bgm.-Dr.-Nebel-Str. 2
97816 Lohr a.Main
Germany
Tel. +49 9352 18 0
Fax +49 9352 18 8400
www.boschrexroth.com/electrics



R911347583